

1. الوصف

الفولاذ المقاوم للصدأ 304/316 الدرابزين القوس حامل الزجاج الدرابزين-
إنهاء: مرآة أو الساتان-
(مختلفة الحجم يتوفر (يرجى موافاتنا بالرسم والكمية لمساعدتنا على اقتباس-

2. صورة المنتج

كتالوج قوس درابزين

STAINLESS STEEL BALUSTRADE AND FITTINGS



SF-30



SF-50



SF-50 T

STAND OFF

Model No. : SF-30	
Material	Stainless steel 304/316
Finish	Satin / mirror polished
Size	30*10mm cap, 30*25mm body, M8*100 bolt, silicon rubber gasket included

Model No. : SF-50	
Material	Stainless steel 304/316
Finish	Satin / mirror polished
Size	50*10mm cap, 50*30mm body, M12*120 bolt, silicon rubber gasket included

Model No. : SF-50 T	
Material	Stainless steel 304/316
Finish	Satin / mirror polished
Size	50*10mm cap, 50*30mm body, silicon rubber gasket included
Mounting plate size	200*160*10mm

HANDRAIL BRACKET

Model No. : P701	
Material	Stainless steel 304/316
Finish	Satin / mirror polished

Model No. : P701R	
Material	Stainless steel 304/316
Finish	Satin / mirror polished

Model No. : P702	
Material	Stainless steel 304/316
Finish	Satin / mirror polished

<http://www.chinabalustrade.com>

Model No. : P702R	
Material	Stainless steel 304/316
Finish	Satin / mirror polished

Model No. : P703	
Material	Stainless steel 304/316
Finish	Satin / mirror polished

Model No. : P703R	
Material	Stainless steel 304/316
Finish	Satin / mirror polished

Model No. : P704	
Material	Stainless steel 304/316
Finish	Satin / mirror polished

Model No. : P704	
Material	Stainless steel 304/316
Finish	Satin / mirror polished

Model No. : P705	
Material	Stainless steel 304/316
Finish	Satin / mirror polished

Model No. : P705	
Material	Stainless steel 304/316
Finish	Satin / mirror polished

Model No. : P707	
Material	Stainless steel 304/316
Finish	Satin / mirror polished

Model No. : P707	
Material	Stainless steel 304/316
Finish	Satin / mirror polished

Model No. : P709	
Material	Stainless steel 304/316
Finish	Satin / mirror polished

Model No. : P708	
Material	Stainless steel 304/316
Finish	Satin / mirror polished

09/10

تصميم المنتج الجديد

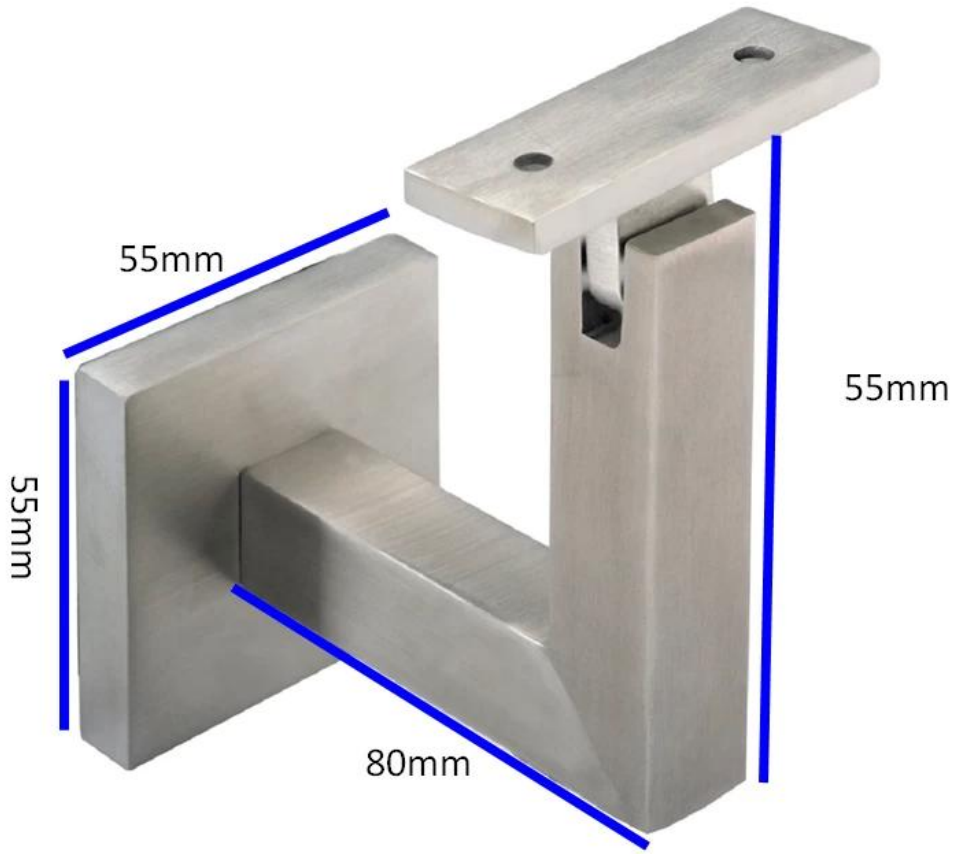



□□□□□□ □□□□ □□□□□□□□ □□□□□



3. التفاصيل







(SS) أنبوب التصميم (نحن تخصيص أنبوب SS + بركة درابزين



قوس هنادرايل + [خفف من الزجاج](#)











قوس درابزين + [المواجهة](#) التصميم



التسليم والتغليف 4.

التسليم: 3-5 أيام قبل إكسبريس. 10-15 يوما قبل الشحن-
التعبئة: جهاز كمبيوتر واحد في كيس بلاستيكي واحد، ثم في مربع واحد-
(المهلة الزمنية: حوالي 20 يوما بعد الدفع. (فإنه دبينت على الكمية-



packing	plastic bag+box+carton
production lead time	30-45 days ; also depending on your qty.
Shippment	 
	 
	 
payment	 

5. المنتجات المرتبطة.

[□□□□ □□□□□□ □□□□](#)

مصنع وإصدار الشهادات-5





6. العملاء





build &
renovating
expo

Friday 4 July - Sunday 6 July 2014
Melbourne Exhibition Centre



الاتصال .7

KEBIL 科比奥®

深圳市朗驰商贸有限公司
SHENZHEN LAUNCH CO., LTD.

朗驰国际有限公司
LAUNCH INTERNATIONAL LIMITED.

董萍 Doris Dong

Senior Sales Representative

☎ (86) 135 3050 6265

深圳市南山区南山大道1092号亿利达大厦B区3栋5003

Room 5003, Building 3, Yilida Building, No.1092
Nanshan Road, Nanshan District, Shenzhen, China
postal code 518054

☎ (86-755) 8603 7559

☎ (86-755) 8637 2611

✉ sales04@launch-china.cn

🌐 www.launch-china.com

www.chinabalustrade.com

شكرا لك لزيارتك. الرجاء القيام هيست لا تتصل بنا لسعر المصنع مباشرة وتقديم المشورة الفنية.