

Kiina toimittaja hintoihin lasi kaiteen kappaleet ruostumattomasta teräksestä yläkiskon

1.glass kaide kappaleet ruostumattomasta teräksestä yläkiskon kuvaus,

materiaali: ruostumatonta 304/316/316

Suorittaa loppuun: Harjattu tai Peilikiillotettu

Lasin paksuus : 8-13.52mm paksuus

Ulottuvuus: Neliön muotoinen, 25 * 20mm, ura 14 * 14mm,

5,8 metrin pituutta kohden, tai kuten teidän vaatimus leikata lohkoiksi

2. lasi kaiteen kappaleet ruostumattomasta teräksestä yläkiskoksi ja varusteet tiedot:

NEW ORDER OF SLOT HANDRAIL IN AUSTRALIA

Slot handrail and fittings

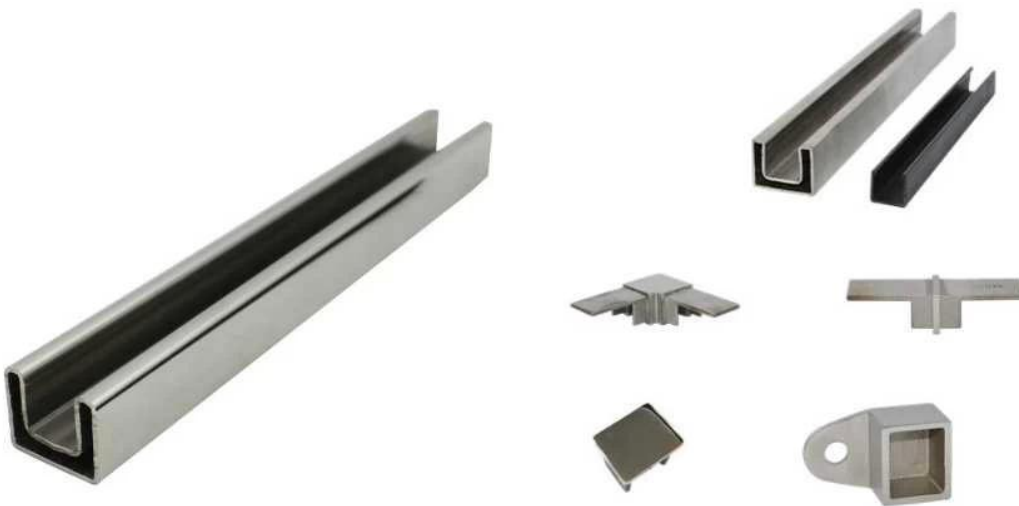

Square slot handrail series

lasi kaiteen kappaleet ruostumattomasta teräksestä yläkiskoksi liittimet valokuvia,

90 degree Corner connector



180 degree middle connector



End Cap



Wall Bracket



90 degree connector drawings

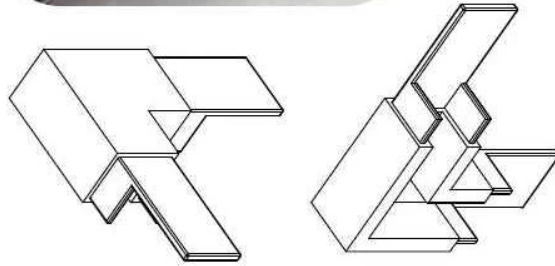
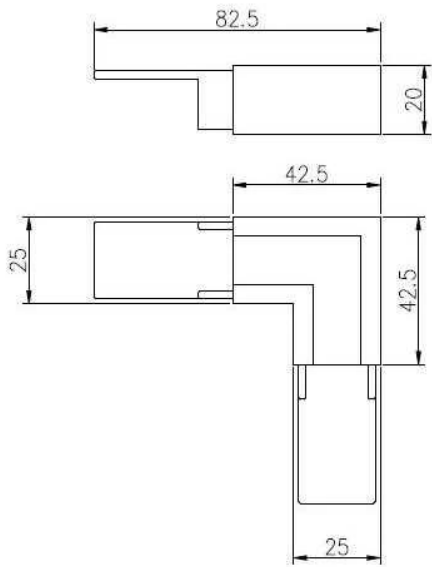

MSQC90

Slot tube handrail + end cap + wall bracket connector drawings

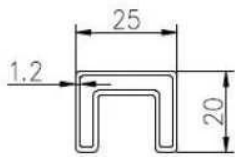

25*20 tube

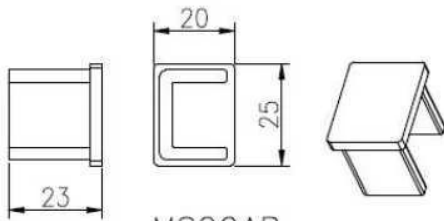
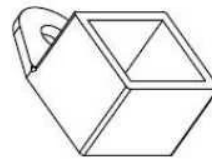
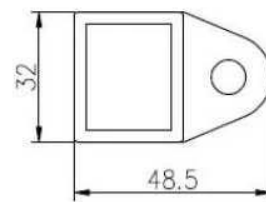
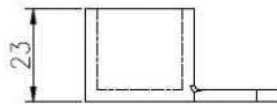

MSQCAP



MSQCW

180 degree connector drawings

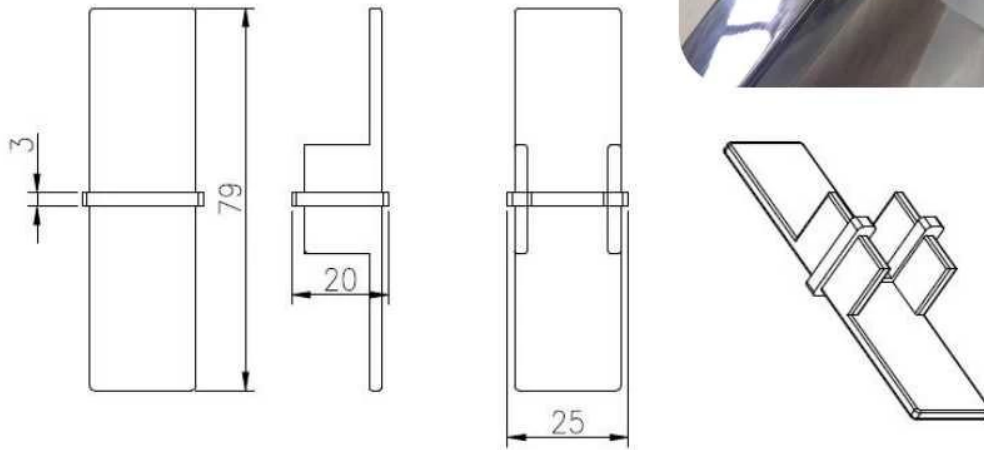

MSQC180

3. lasi kaiteen kappaleet ruostumattomasta teräksestä vläkiskon projekti:



Outdoor balcony Project



Outdoor deck Project



4.lasi kaiteen kappaleet ruostumattomasta teräksestä alkuun rautatiepakettia,

Woven bag / Safe Cardboard tube packaging



Kiitos vierailun tahansa kiinnostunut tai tarpeita, ota yhteyttä minuun vapaasti:

Joey Lan

Shenzhen Launch Co, Ltd

www.launch-china.com www.launch-china.en.alibaba.com www.chinabalustrade.com

Sähköposti: sales02@launch-china.cn.

Skype: käynnistää-02. Office: 86-755-86037559.