

Ανοξείδωτο ατσάλι με αράχνη που χωράει σε γυάλινο  
κουβούκλιο





**1. Ανοξείδωτο τετράγωνο Spider Post Ballast Προδιαγραφές :**

<b>Προϊόν Ονομα</b>	Ανοξείδωτο τετράγωνο ασημένιο ταχυδρομείο
<b>Αριθμός Μοντέλου.</b>	LCH-121
<b>Υλικό</b>	Ανοξείδωτο ατσάλι 304/316
<b>Φινίρισμα</b>	Βουρτσισμένο ή καθρέφτη γυαλισμένο
<b>Τετράγωνο μέγεθος ταχυδρομείου</b>	Πάχος τοιχώματος 50 x 50 x 1,5 χιλιοστά Πάχος τοιχώματος 40 x 40 x 1,5 χιλιοστά
<b>Υψος</b>	Προσαρμόσιμα
<b>Για το πάχος γυαλιού</b>	10-15mm
<b>Εφαρμογή</b>	Σχεδιασμός κιγκλιδώματος μπαλκονιού Σχεδιασμός κιγκλιδωμάτων Σχεδιασμός κιγκλιδώματος καταστρώματος Σχεδιασμός κιγκλιδώματος σκαλοπατιών



2. Από ανοξείδωτο χάλυβα πλατεία αράχνη Post Διάσταση Σχέδιο Για την αναφορά σας:

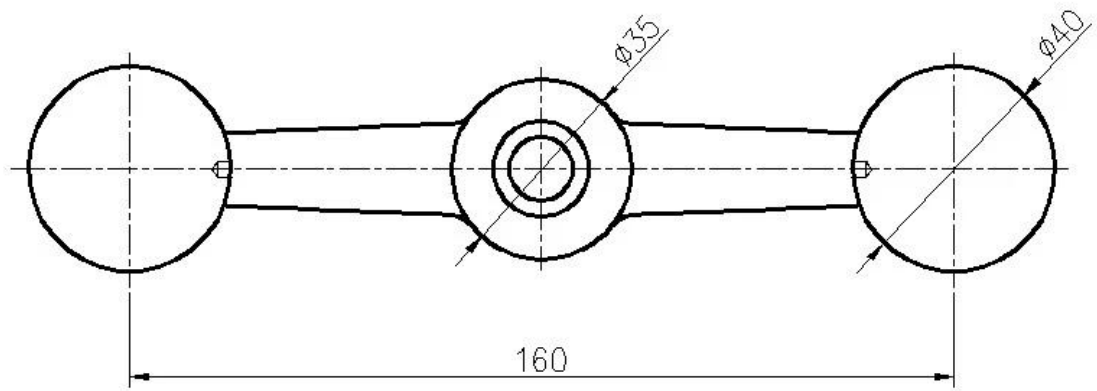
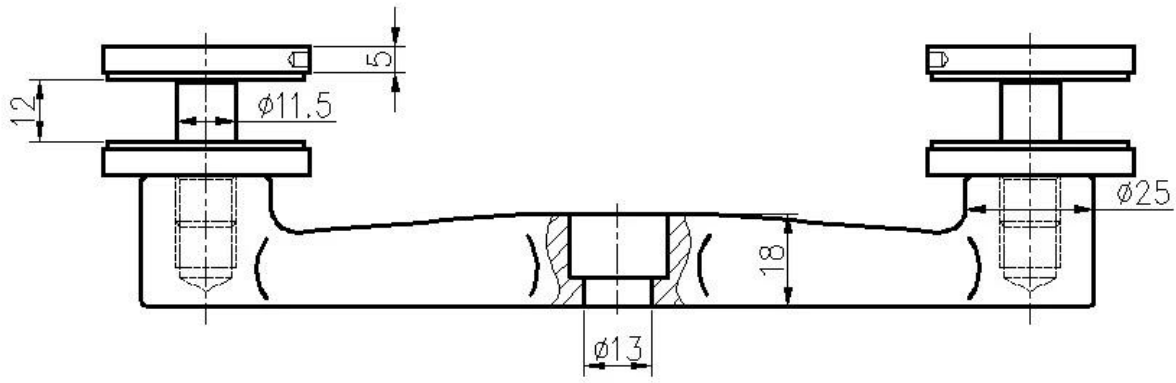

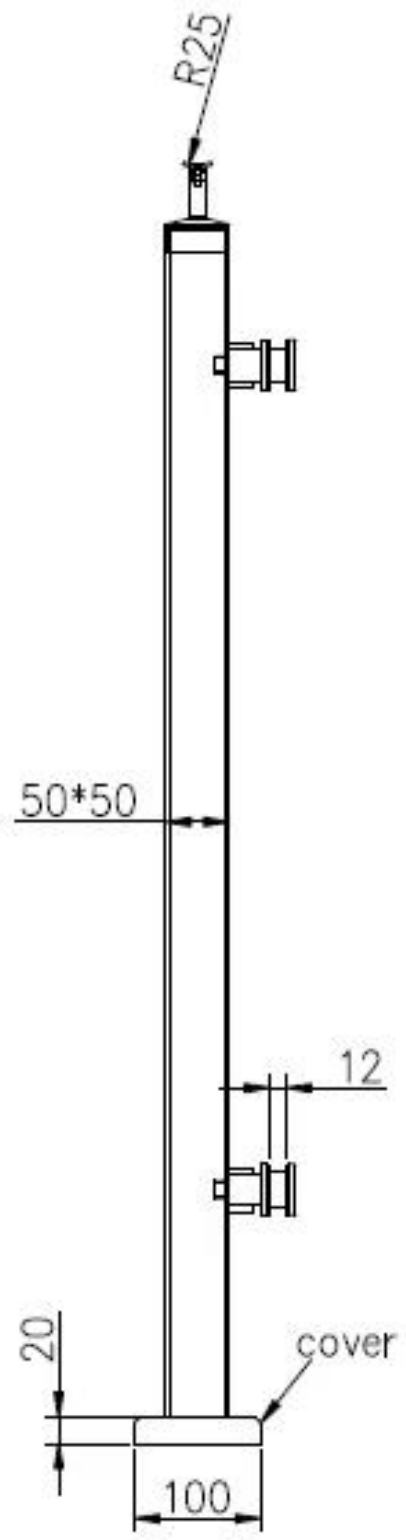
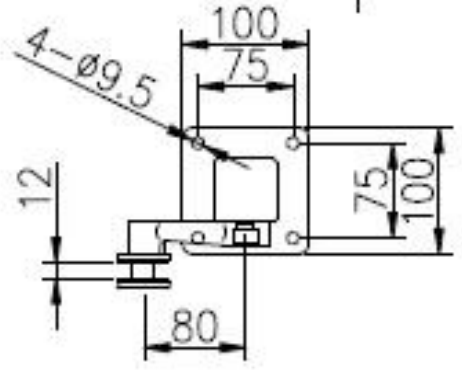
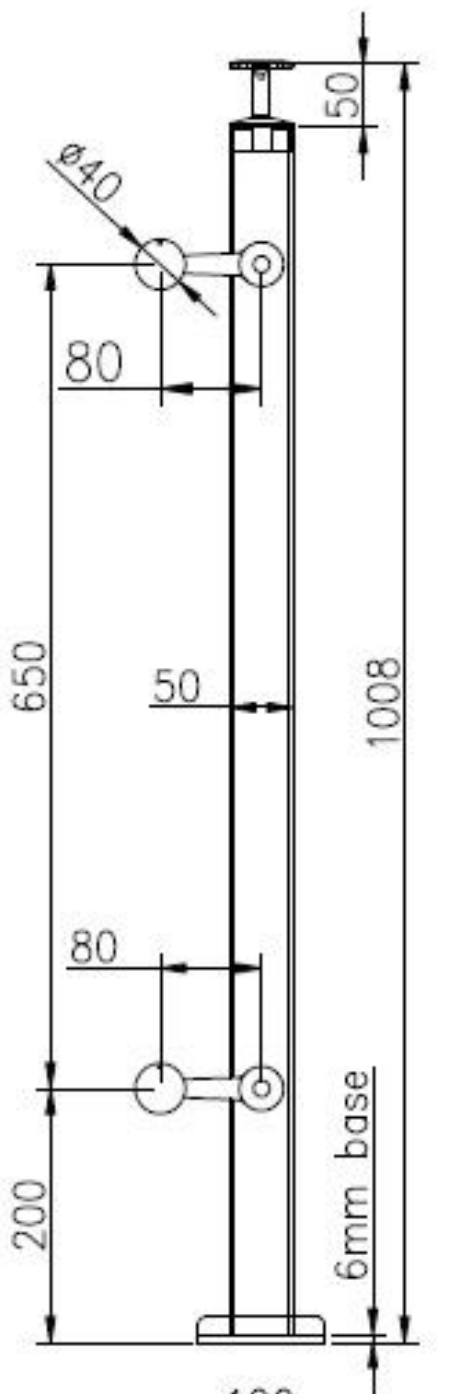

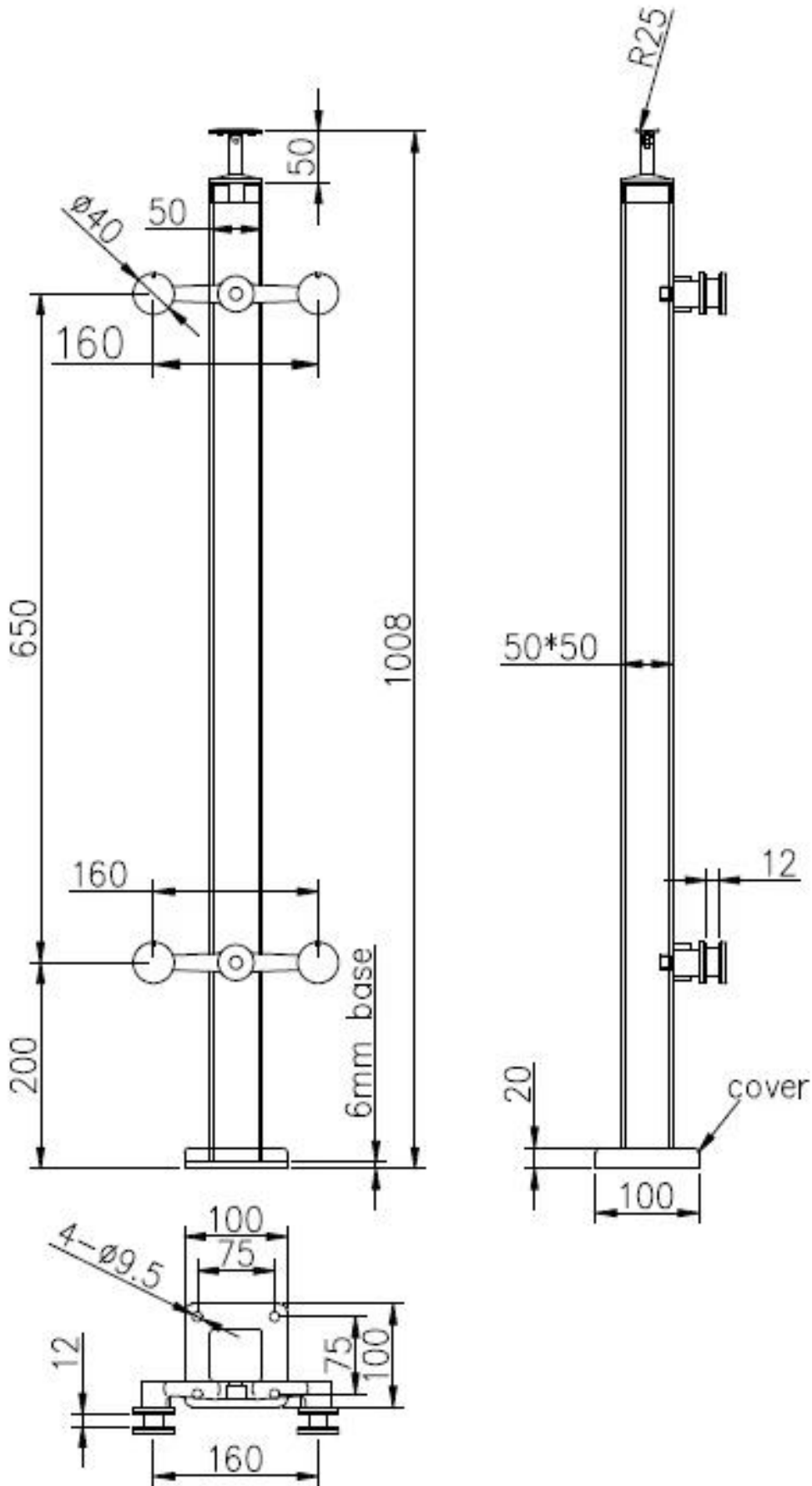

3. Από ανοξείδωτο ατσάλι Baluster Post Φωτογραφίες:  
 Κορυφαίος ρυθμιζόμενος βραχίονας χειρολαβής για κιγκλιδώματα

τετράγωνου ή στρογγυλού σωλήνα:



2 Μέση Ενδιάμεση Θέση:





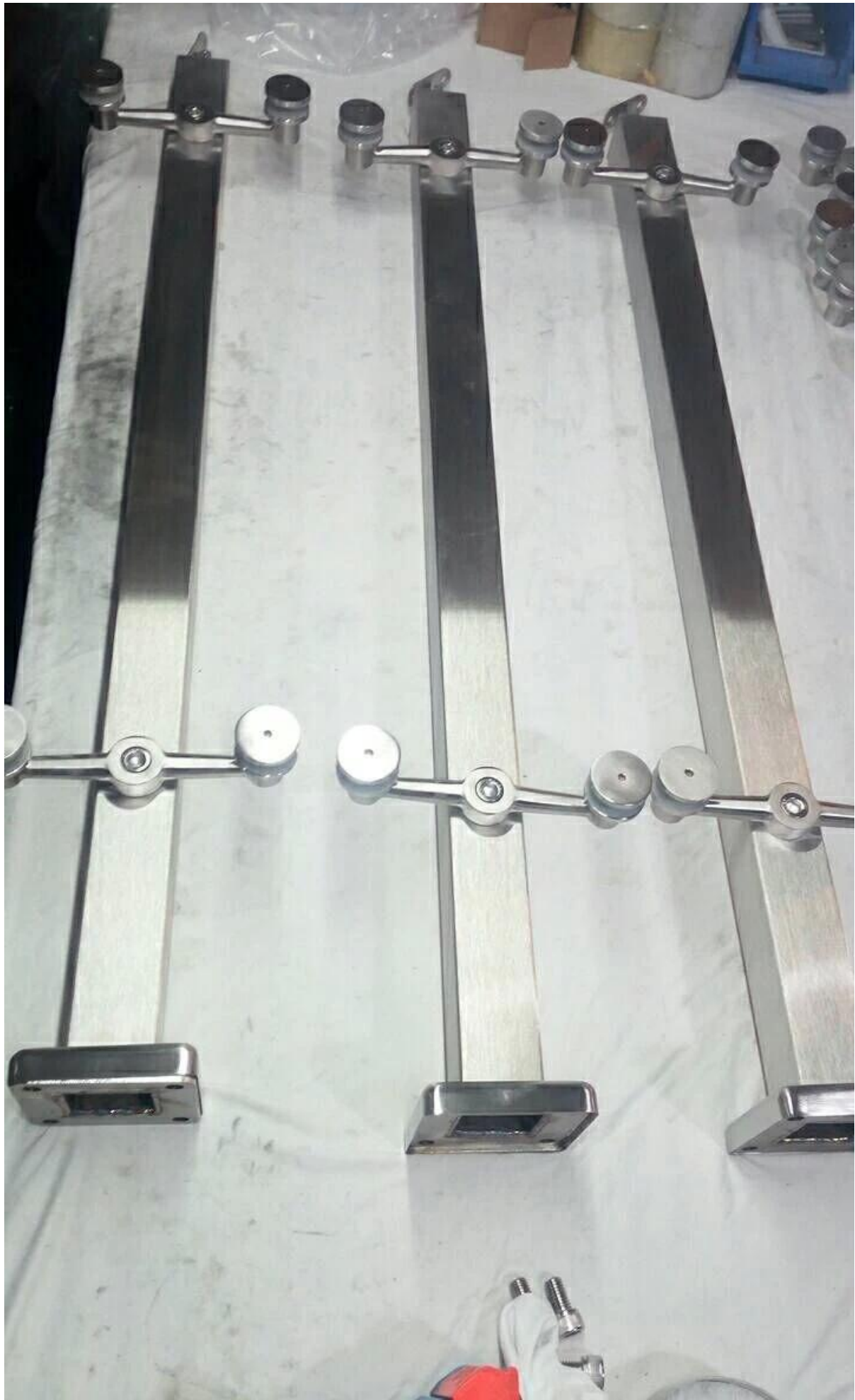

1 τρόπος τελικής διαδρομής:



4. Φωτογραφίες συσκευασίας: 1pc / πλαστική σακούλα, 2 - 4pcs / ctn.





Άλλοι τύποι εξαρτημάτων αράχνης:

- Ανοξείδωτο ασάλινο τοίχο για κουρτίνα



- Εξαρτήματα OEM Spider για συστήματα κιγκλιδωμάτων από γυαλί

**KEBIL** 科比奥®



Εταιρία Πληροφορίες:

Shenzhen Launch Co., Ltd was established in 2004, located at Nanshan District, Shenzhen, and one hour by car from Hongkong International Airport. Our main product is high-grade building materials includes stainless steel balustrade post, staircase handrail, balcony guardrail, swimming pool fence and other high-grade building materials. All the products are designed strictly according to the high-end market requirements. We have our own factory in Tangxia Town, Dongguan, has a variety of precision equipment more than 50 sets: CNC lathe, milling machine, punching machine, pipe cutter, argon welder, drilling machine, polisher, etc. which can provide customers with complete product processing services. With the German SPECTRO Spectrometer, we insist on testing every batch of materials to ensure that the material is highly qualified. We also have hardness gauge, secondary element and other test equipment to ensure the products meets customers' requirements.

## ABOUT US



# OUR ADVANTAGE

Please do not hesitate to contact us if you have any requirement regarding our production lines, you can expect a timely reply with professional solutions!



Own factory, shortest lead time.



Can help customers design product drawings based on customer ideas and design engineering installation drawing according to the customer site sketch.



Sample order, trial order acceptable.



Provide material test report to ensure that the material is qualified.



13 years of industry experience, we can help customers recommend the best solution to help customers save cost.

# OUR FACTORY

More than 13 years experience in hardware industry design and processing, we can provide customized services from design to the sample and small batch trial production.



# OUR CERTIFICATE

With premium quality, competitive price and superior service, we won a lot of customers' favor.  
Our products are popular in North America, European and Australia.





# PRODUCTION PROCESS



Casting



CNC lathe



CNC Milling



Stamping



Drilling & Tapping



Polishing



# ***PACKAGING & DELIVERY***



# PAYMENT & TRANSPORTATION

Welcome Alibaba Trade Assurance Order!

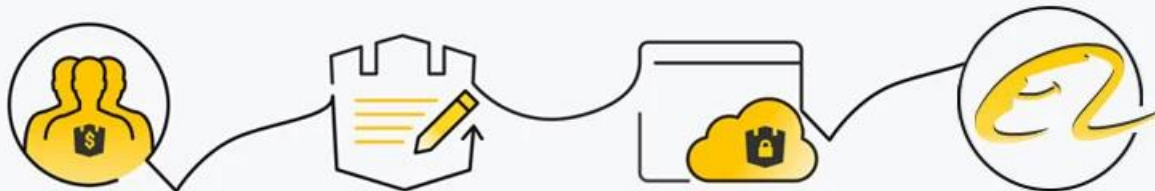

1 Start an order

2 Negotiate terms with our sales service & confirm order

3 Make payment

4 Alibaba provide full assurance



XPL FedEx<sup>®</sup>  
Express

EMS<sup>®</sup>

DHL

TNT



Επικοινωνήστε μαζί μας δωρεάν για περισσότερες πληροφορίες:

Email: [sales03@launch-china.cn](mailto:sales03@launch-china.cn)

Επικοινωνία: Eve Chow

WhatsApp / HP: +8615907334556