

2020 Base in alluminio Scarpiera Ringhiera in vetro Balcone Canale a U senza telaio Balastra in vetro da 12 mm a 21,52 mm

Specifiche del profilo del canale a U in alluminio:

PARTE RAILING - BASEMENT	MATERIALE	Dimensioni (mm)	SUPERFICIE FINITA	SPESSORE VETRO ADATTO (MM)
Profilo U / Profilo U.	Alluminio ALLOY	102 * 62	Vernice anodizzante / spray	12-13,52
		102 * 67		8 + 1,52 + 8
		102 * 70,5		10 + 1.52 + 10
Sistema interno e bullone	3 o 4 metri per lunghezza			
rivestimento	SUS 304 / SUS 316	102	Spazzolato / Specchio	/
Gomma da cancellare	Plastica	vario	Nero	Tutti

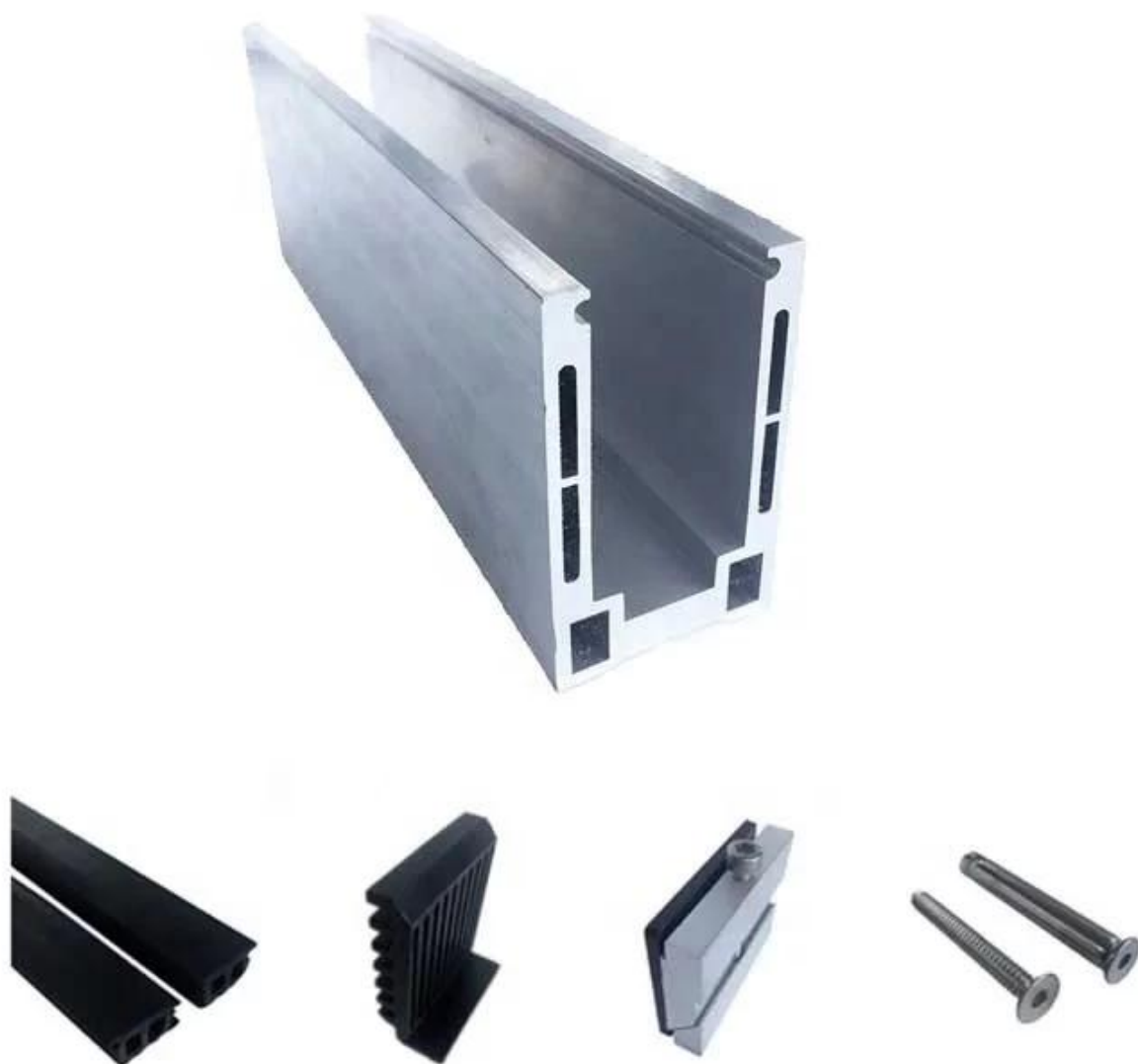



A disposizione Modelli:

LCH-A01 / A02: senza / con rivestimento per l'uso con vetro da 20 mm a 21,52 mm

LCH-A01



20 mm to 21.52 mm tempered glass

1 m aluminium groove contains the following accessories
(excluding glass)



LCH-A02



20 mm to 21.52 mm tempered glass

1 m aluminium groove contains the following accessories
(excluding glass)



LCH-B01 / A02: senza / con rivestimento per l'uso con vetro da 16mm a 17,52mm

LCH-B01



16 mm to 17.52 mm tempered glass

1 m aluminium groove contains the following accessories
(excluding glass)



LCH-B02



16 mm to 17.52 mm tempered glass

1 m aluminium groove contains the following accessories
(excluding glass)

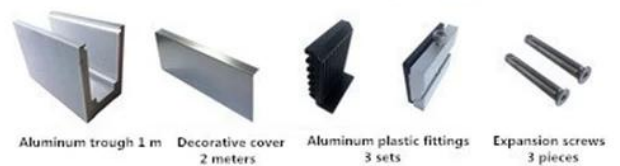

LCH-C01 / A02: senza / con rivestimento per l'uso con vetro da 12 mm a 13,14 mm

LCH-C01



12 mm to 13.14 mm tempered glass

1 m aluminium groove contains the following accessories (excluding glass)

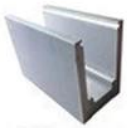

Aluminum trough 1 m Waterproof tape 2 meters



Aluminum plastic fittings 3 sets



Expansion screws 3 pieces

LCH-C02



12 mm to 13.14 mm tempered glass

1 m aluminium groove contains the following accessories (excluding glass)

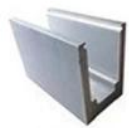

Aluminum trough 1 m



Decorative cover 2 meters



Aluminum plastic fittings 3 sets



Expansion screws 3 pieces

LCH-D01 / A02: senza / con rivestimento per l'uso con vetro da 12 mm a 13,14 mm

LCH-D01



12 mm to 13.14 mm tempered glass

1 m aluminium groove contains the following accessories (excluding glass)



Aluminum trough 1 m Waterproof tape 2 meters



Aluminum plastic fittings 3 sets



Expansion screws 3 pieces

LCH-D02



12 mm to 13.14 mm tempered glass

1 m aluminium groove contains the following accessories (excluding glass)



Aluminum trough 1 m



Decorative cover 2 meters



Aluminum plastic fittings 3 sets



Expansion screws 3 pieces

Per applicazioni commerciali e residenziali
Sia all'ingrosso che al dettaglio (Siamo produttori)









ALTRI TIPI DI CANALE IN ALLUMINIO U PER RAILING IN VETRO:

Small profile: for glass thickness 10-12.76mm

Big profile: for glass thickness 20-30mm

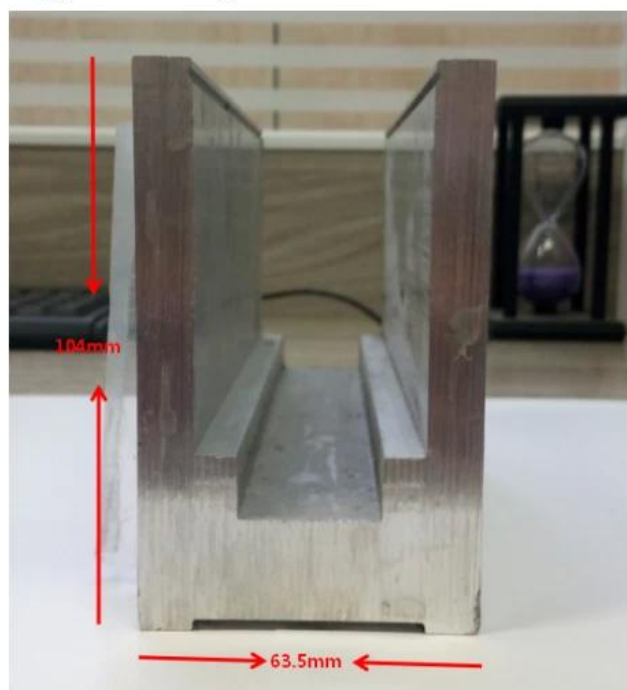
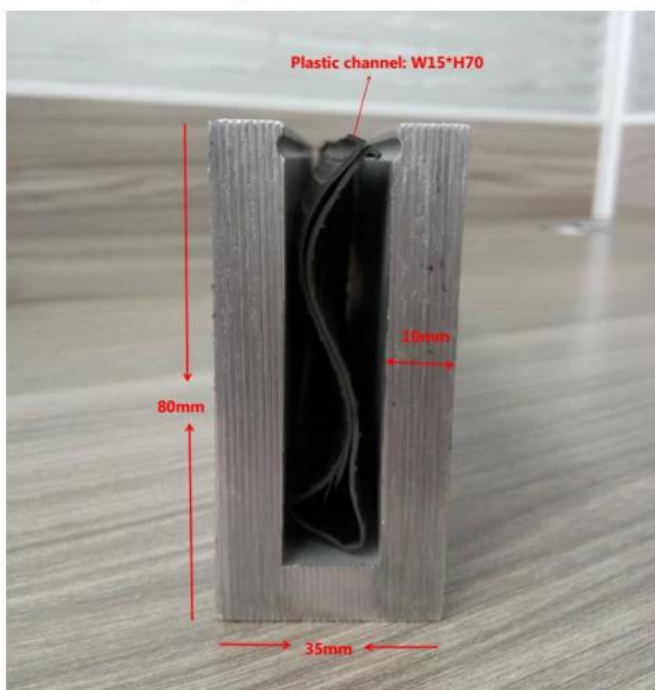

MANIGLIONE TUBO SLOT:

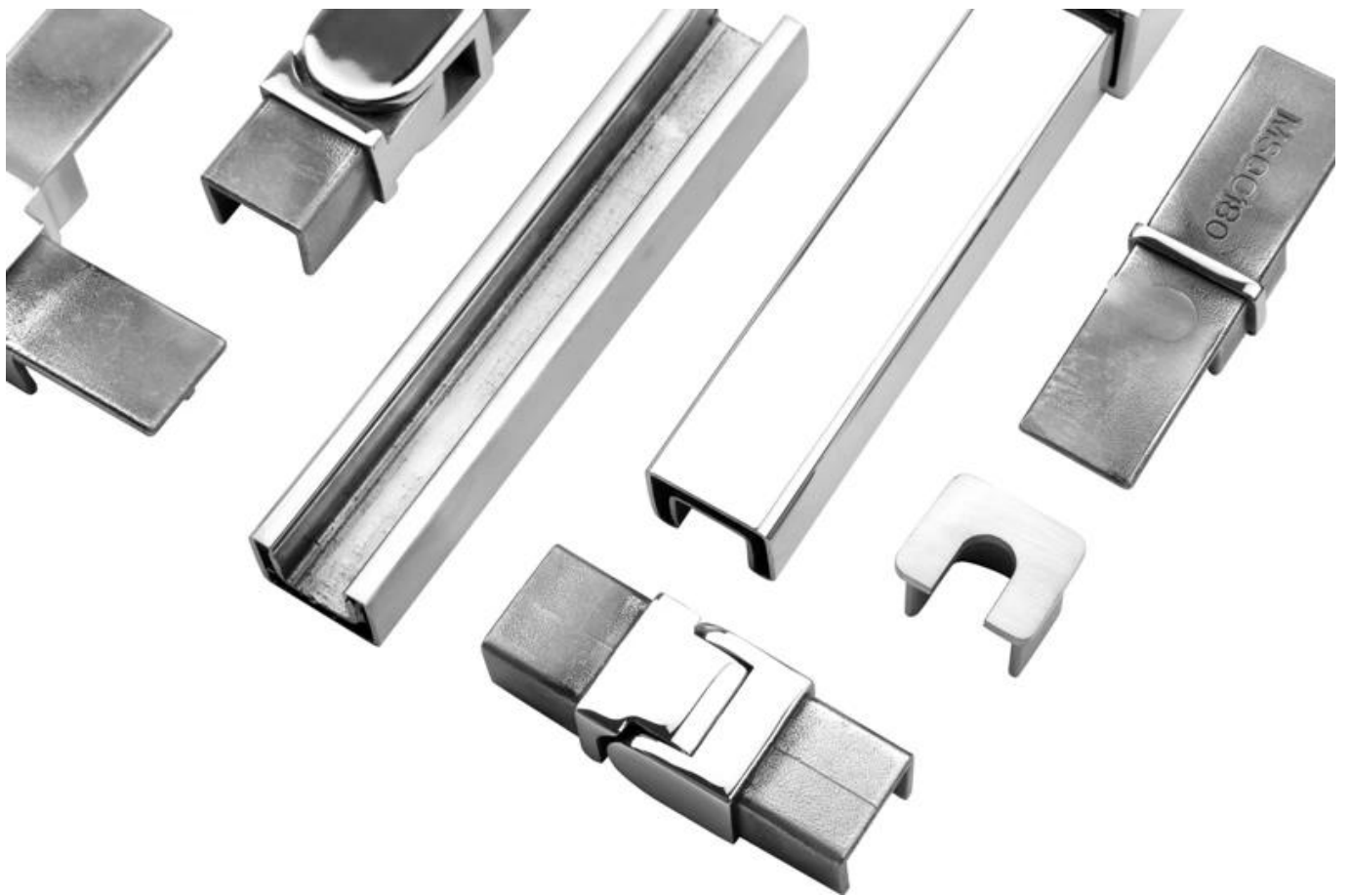



FAQ

1. sei fabbrica?

Sì, siamo fabbrica.

2. Offrite campioni gratuiti?

Sì, offriamo campioni gratuiti, ma i clienti devono pagare le spese espresse.

3. Che materiali hai?

Abbiamo il materiale di acciaio inossidabile 304, 316, 316L e Duplex 2205.

4. Qual è il tuo MOQ?

Il MOQ dell'ordine richiesto è 1 pz.

5. Che tipo di pagamento accettate?

Accettiamo il pagamento di T / T, LC, PayPal, West Union, ecc.

6. Qual è il termine di pagamento?

Il nostro termine di pagamento è T / T (100% o 30/70) o LC a vista.

7. Qual è il tempo di consegna?

I nostri tempi di consegna vanno da 5 giorni a 30 giorni in base alla quantità.

8. Offrite il servizio OEM e ODM?

Sì, offriamo il servizio OEM e ODM.

9. Offrite un servizio post-vendita?

Sì, offriamo un servizio post-vendita. Qualsiasi reclamo per gli ordini verrà risolto in tempo entro 12 ore.

Contattaci ora per maggiori informazioni:

vigilia

Email: sales03@launch-china.cn

Mobile / Whatsapp: +8613686807796