

## **Aluminiowe relingi balustradowe / balustrady szklane / balustrady szklane kanałowe U na balkon**

### **Specyfikacja profilu aluminiowego U-kanałowego:**

Pozycja	Szyna zespolona ze szkła typu U, aluminiowa szyna ze szkła kanałowego, aluminiowa balustrada ze stopu szklanego
Materiał	Aluminium 6063 T3
koniec	Anodowane / malowane proszkowo
Rozmiar	35 * 80 mm / 63,5 * 104 mm itp
Grubość szkła	12 mm do 25 mm
Typy rur szczelinowych	Okrągłe lub kwadratowe
Instalacja	Wkręty / śruby samogwintujące / przeciwwybuchowe
Montowanie	Montaż podłogowy / naścienny
Podanie	Balkon, taras, weranda, schody, taras, hol, centrum handlowe
Dostawa	15-30 dni

Do zastosowań komercyjnych i mieszkaniowych  
Dla handlu hurtowego i detalicznego (jesteśmy producentem)

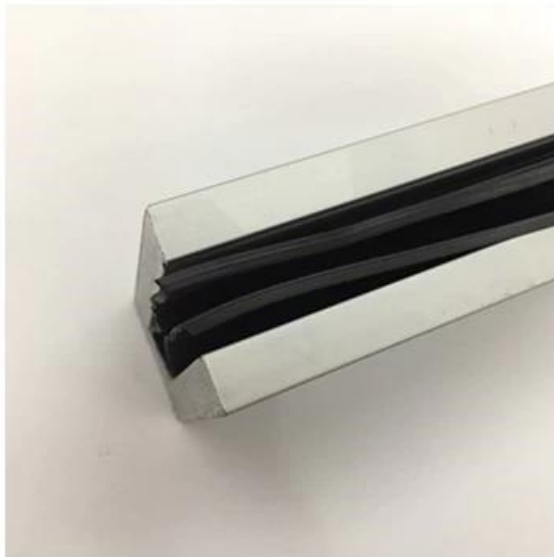
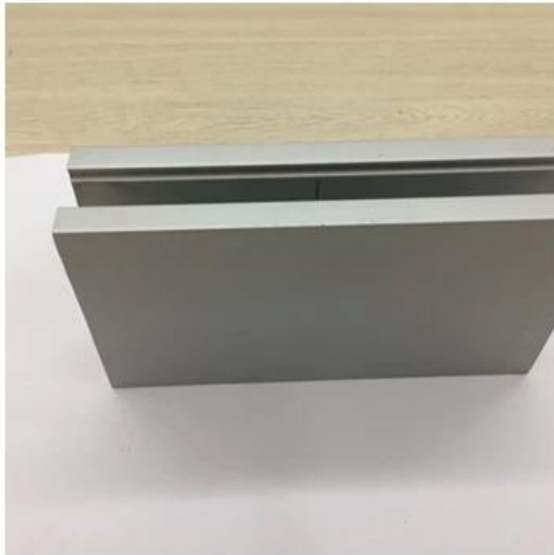
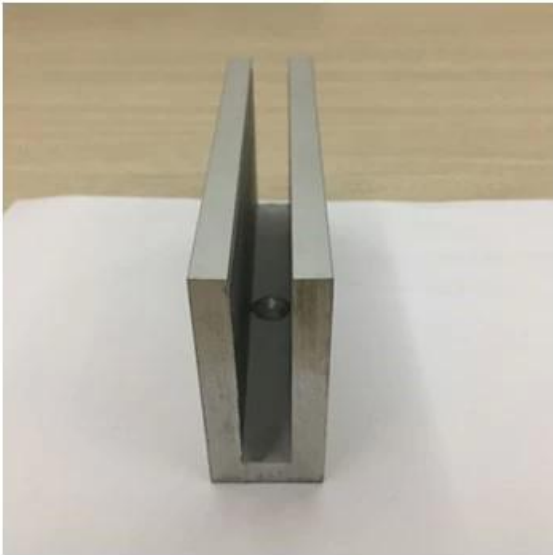





**SMALL i & KANAŁ Z DUŻYMI ALUMINIOWYMI KOLANKAMI SZKLANYMI:**

Small profile: for glass thickness 10-12.76mm

Big profile: for glass thickness 20-30mm

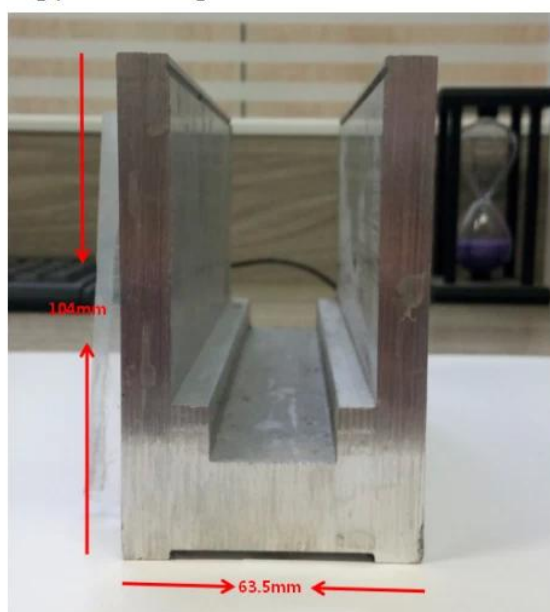
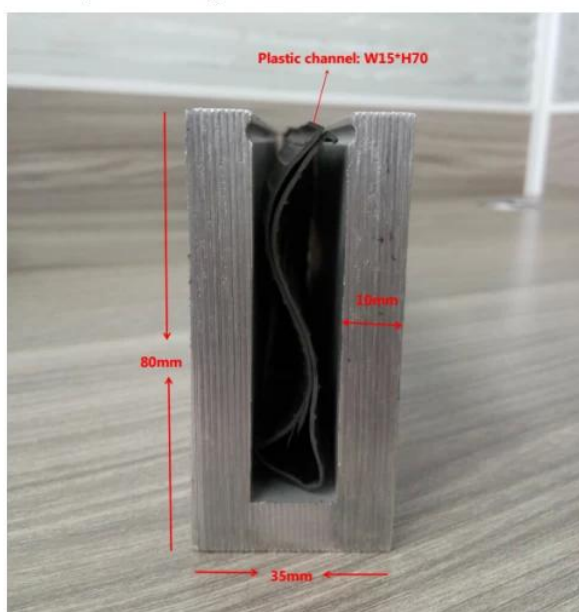

**RĘKAWICA Z RURAMI:**

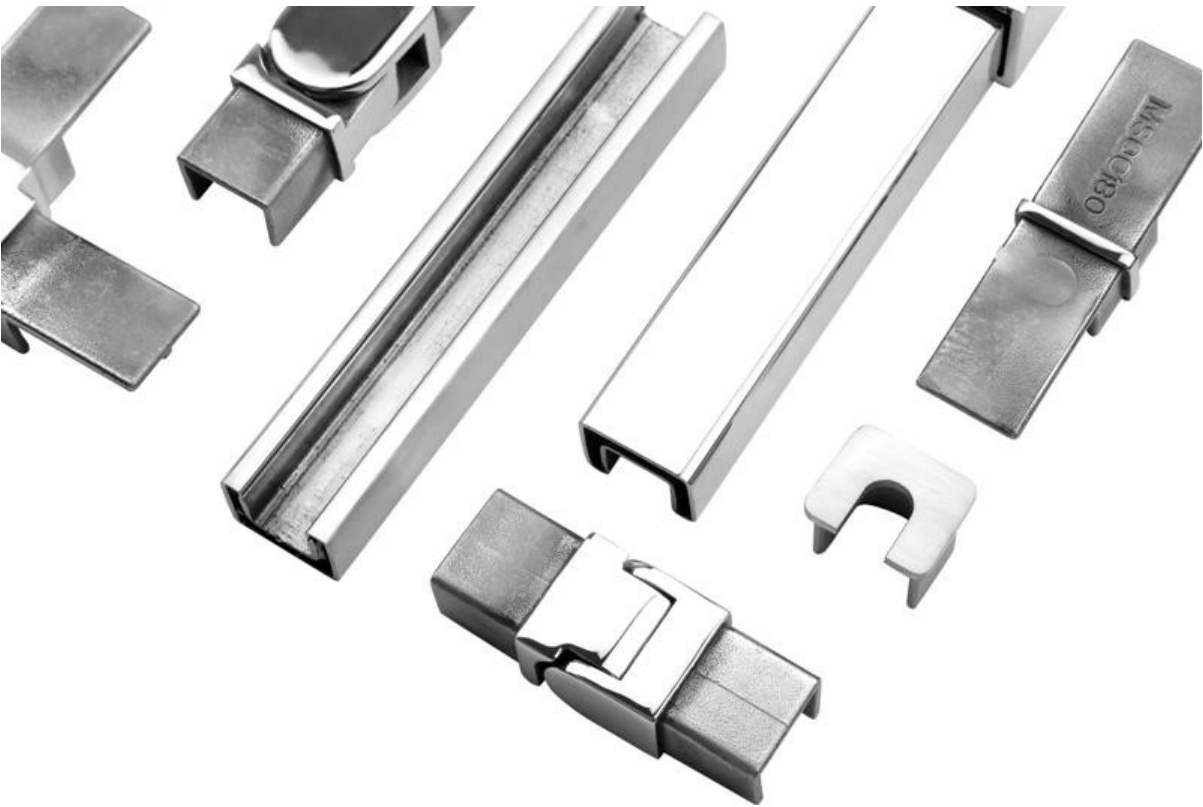



Shenzhen Launch Co., Ltd was established in 2004, located at Nanshan District, Shenzhen, and one hour by car from Hongkong International Airport. Our main product is high-grade building materials includes stainless steel balustrade post, staircase handrail, balcony guardrail, swimming pool fence and other high-grade building materials. All the products are designed strictly according to the high-end market requirements. We have our own factory in Tangxia Town, Dongguan, has a variety of precision equipment more than 50 sets: CNC lathe, milling machine, punching machine, pipe cutter, argon welder, drilling machine, polisher, etc. which can provide customers with complete product processing services. With the German SPECTRO Spectrometer, we insist on testing every batch of materials to ensure that the material is highly qualified. We also have hardness gauge, secondary element and other test equipment to ensure the products meets customers' requirements.

## ABOUT US



# OUR ADVANTAGE

Please do not hesitate to contact us if you have any requirement regarding our production lines, you can expect a timely reply with professional solutions!



Own factory, shortest lead time.



Can help customers design product drawings based on customer ideas and design engineering installation drawing according to the customer site sketch.



Sample order, trial order acceptable.



Provide material test report to ensure that the material is qualified.



13 years of industry experience, we can help customers recommend the best solution to help customers save cost.

# OUR FACTORY

More than 13 years experience in hardware industry design and processing, we can provide customized services from design to the sample and small batch trial production.





# OUR CERTIFICATE

With premium quality, competitive price and superior service, we won a lot of customers' favor.  
Our products are popular in North America, European and Australia.



# PRODUCTION PROCESS



Casting



CNC lathe



CNC Milling



Stamping



Drilling & Tapping



Polishing



# PAYMENT & TRANSPORTATION

Welcome Alibaba Trade Assurance Order!

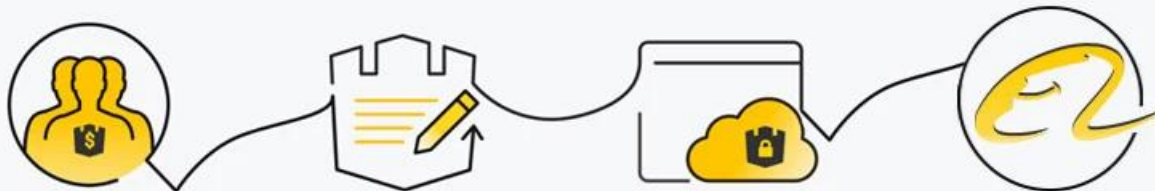

1 Start an order

2 Negotiate terms with our sales service & confirm order

3 Make payment

4 Alibaba provide full assurance



PayPal



VISA

HSBC



XPL FedEx<sup>®</sup>  
Express

EMS<sup>®</sup>

DHL

TNT



## FAQ

1. Czy jesteście fabrycznie?

Tak, jesteśmy w fabryce.

2. Czy oferujecie darmowe próbki?

Tak, oferujemy bezpłatne próbki, ale klienci muszą płacić ekspresowe opłaty.

3. Jakie macie materiały?

Posiadamy materiał ze stali nierdzewnej 304, 316, 316L i Duplex 2205.

**4. Jakie jest Twoje MOQ?**

**MOQ wymaganego zamówienia to 1 szt.**

**5. Jakiego rodzaju płatność akceptujesz?**

**Akceptujemy płatności T / T, LC, PayPal, West Union itp.**

**6. Jaki jest twój termin płatności?**

**Nasz termin płatności to T / T (100% lub 30/70) lub LC na widoku.**

**7. Jaki jest twój czas dostawy?**

**Nasz czas dostawy wynosi od 5 dni do 30 dni w zależności od ilości.**

**8. Czy oferujecie OEM & Usługa ODM?**

**Tak, oferujemy usługi OEM i ODM.**

**9. Czy oferujecie usługi posprzedażne?**

**Tak, oferujemy usługi posprzedażne. Wszelkie reklamacje dotyczące zamówień będą rozpatrywane w terminie w ciągu 12 godzin.**

**Skontaktuj się z nami aby uzyskać więcej informacji:**

**Przeddzień**

**Email: sales03@launch-china.cn**

**Mobile / Whatsapp: +8615907334556**