

Armatura Chiny dostawca ceny fabryki szkła balustrady ze stali nierdzewnej
górną szynę

Armatura 1.glass balustrady ze stali nierdzewnej opis górną szynę,

Materiał: stal nierdzewna 304/316 / 316L

Koniec: Szczotkowana lub polerowanej

Dla grubości szkła : 8-13.52mm grubości

Wymiar: Kwadratowy kształt, 25 * 20mm, groove 14 * 14mm,

5,8 metra na długości, albo jak na swoje wymagania pocięte na części

2. Okucia szklane balustrady ze stali nierdzewnej szynie i armatura szczegóły:

NEW ORDER OF SLOT HANDRAIL IN AUSTRALIA

Slot handrail and fittings

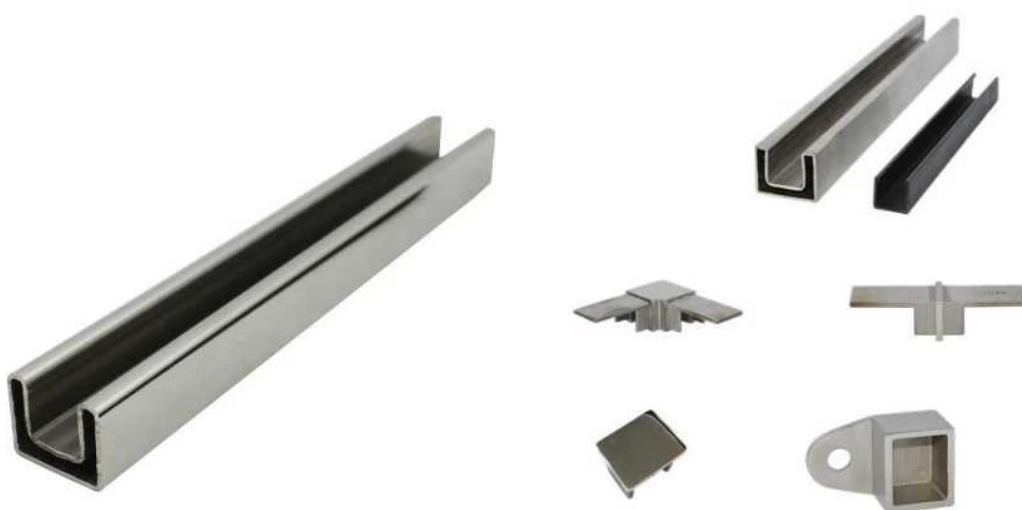

Square slot handrail series

Kształtki szklane balustrady ze stali nierdzewnej złącza szynie zdjęciami,

90 degree Corner connector



180 degree middle connector



End Cap



Wall Bracket



90 degree connector drawings

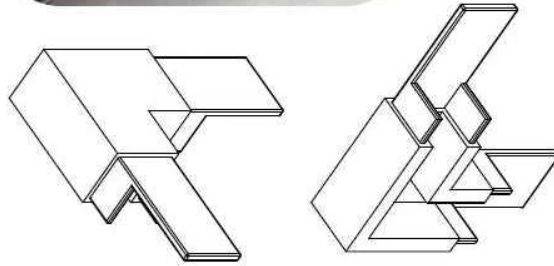
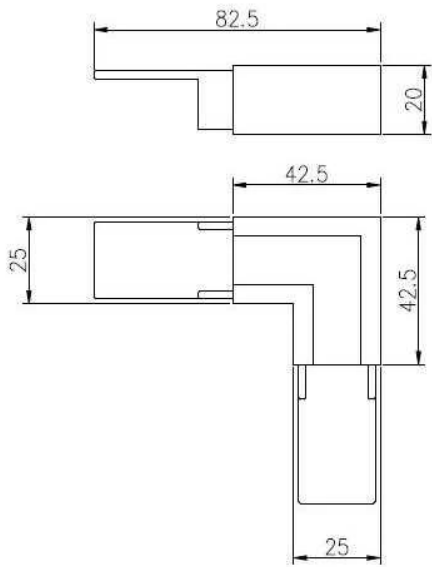

MSQC90

Slot tube handrail + end cap + wall bracket connector drawings

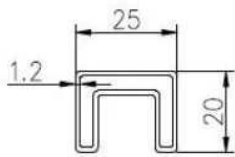

25*20 tube

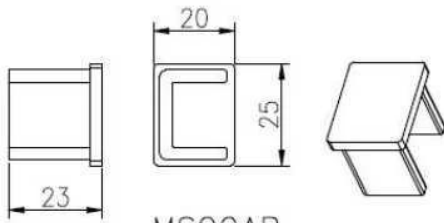
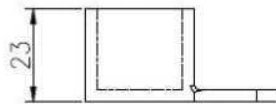

MSQCAP

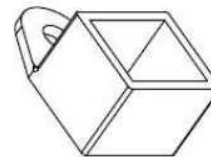
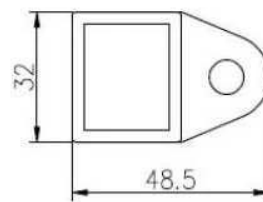

MSQCW

180 degree connector drawings

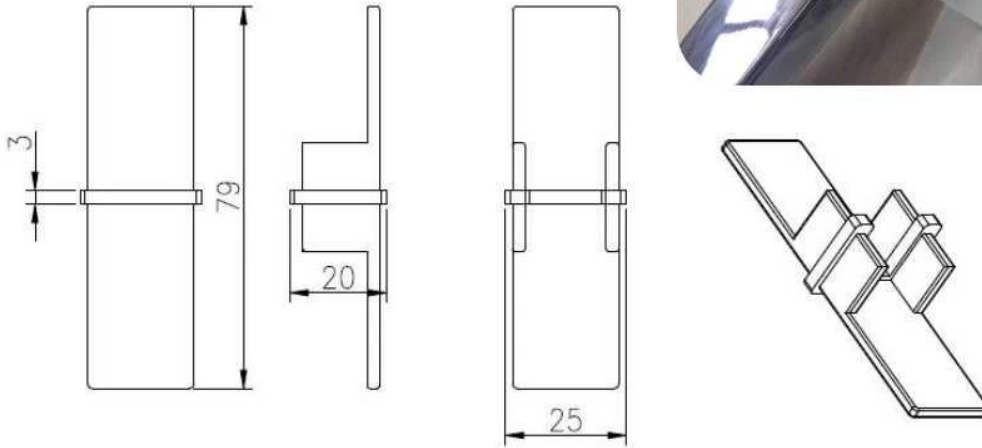

MSQC180

3. Kształtki szklane balustrady ze stali nierdzewnej górna szyna projekt:



Outdoor balcony Project



Outdoor deck Project



4.Kształtki szklane balustrady ze stali nierdzewnej najwyższej pakietu kolejowego,

Woven bag / Safe Cardboard tube packaging



Dzięki za odwiedziny, Każda zainteresowana lub potrzeb, skontaktuj się ze mną swobodnie:

Joey Lan

Wprowadzenie Shenzhen Co., Ltd

www.launch-china.com www.launch-china.en.alibaba.com www.chinabalustrade.com

E-mail: sales02@launch-china.cn.

Skype: launch-02. Kancelarii: 86-755-86037559.