

Description

--Glass heavy gate to square post or wall spring hinge G-W2 for home outdoor design pool fencing railing

--Model No.:G-w2

--For glass to square post/wall

--Manufacture method:casting

--Can hold ≤ 20 KG glass (1000x1000x8mm glass)

--Packaging: one pc into one plastic bag, then into one box. 12 pcs into one carton.

--MOQ: one pc

--Delivery: by air/by sea

--Application:swimming pool fence,baclony design railing,semi frameless glass railing,glass to stainless steel square post hinge,glass to aluminum square post hinge,glass to wall hinge,outdoor home design

--For both commerical and modern house home design

--For both wholesale and retail (We are factory)

--Sample is always available

Product Details

Sarin finish





Mirror finish



Drilled glass hole drawing

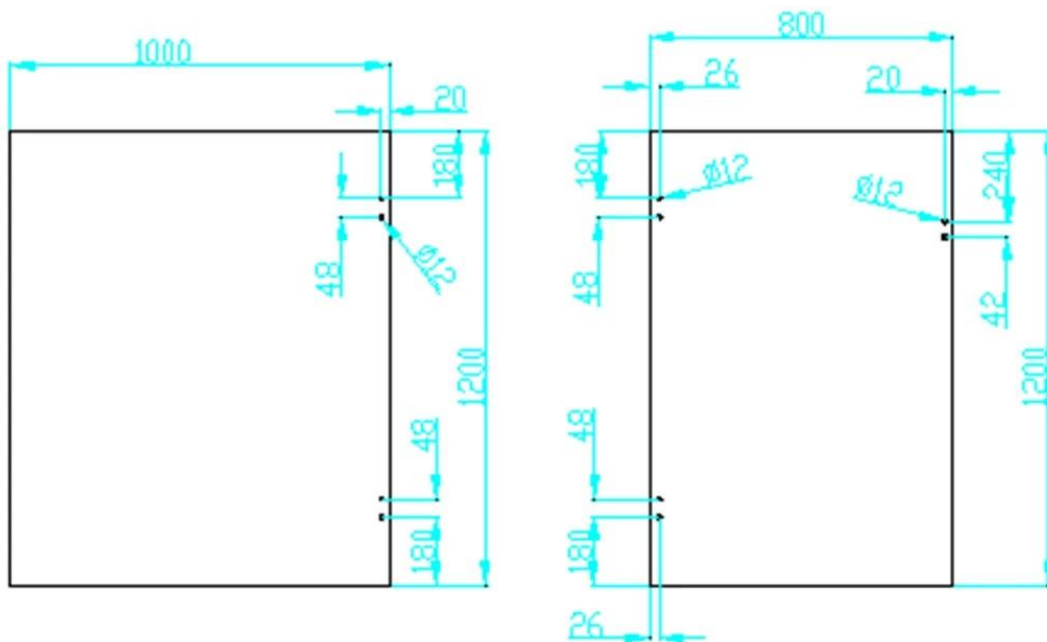

Project









Glass hinge is usually matched with [glass spigot](#) and [glass latch](#).



For more beautiful pool fence project photos, go [here](#)

Packing & Delivery

- One pc into one plastic bag, then into one box.
- Regular lead time: 10-15 days after payment. It is according to quantity.
- Shipping time: 5-7 days by express. 15-20 days by sea.

packing	plastic bag+box+carton
production lead time	30-45 days ; also depending on your qty.
Shippment	 
	   
payment	 

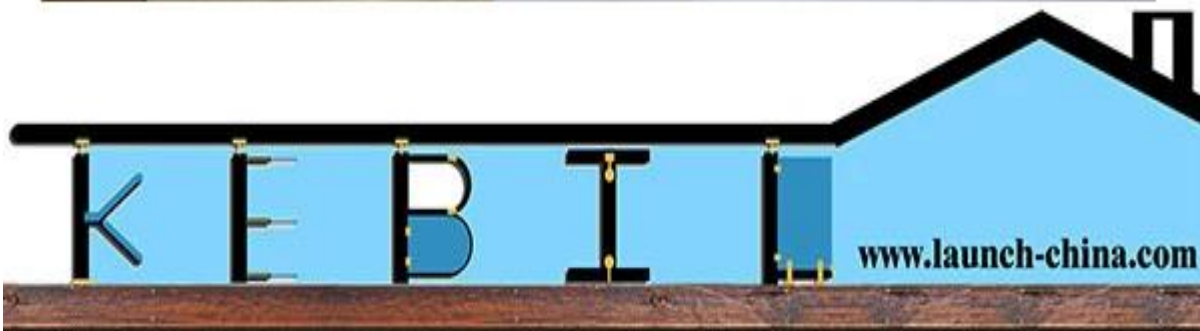

Factory & Certification





Need a quote or any questions? please leave a message.
Or contact me as below info. will get back to you ASAP!

KEBIL 科比奥
深圳市朗驰商贸有限公司
SHENZHEN LAUNCH CO., LTD.
朗驰国际有限公司
LAUNCH INTERNATIONAL LIMITED.

董萍 Doris Dong

Senior Sales Representative

☎ (86) 135 3050 6265

深圳市南山区南山大道1092号亿利达大厦B区3栋5003
 Room 5003, Building 3, Yilida Building, No.1092
 Nanshan Road, Nanshan District, Shenzhen, China
 postal code 518054

☎ (86-755) 8603 7559

☎ (86-755) 8637 2611

✉ sales04@launch-china.cn

🌐 www.launch-china.com

🌐 www.chinabalustrade.com

