

Description

- Glass to glass door spring hinge
- Model No.:G-G1
- Manufacture method:stamping
- Can hold ≤ 20 KG glass (1000x1000x8mm glass)
- Sheet metal thickness: 2.5mm
- Packaging: one pc into one plastic bag, then into one box. 12 pcs into one carton.
- MOQ: one pc
- Delivery: by air/by sea
- Application:safe pool fence glass door,glass railing,baclony design railing
- For both commerical and modern house home design
- For both wholesale and retail (We are factory)
- Sample is always available

Product Details

Mirror & sarin finish







Customize longer type



Drilled glass hole drawing

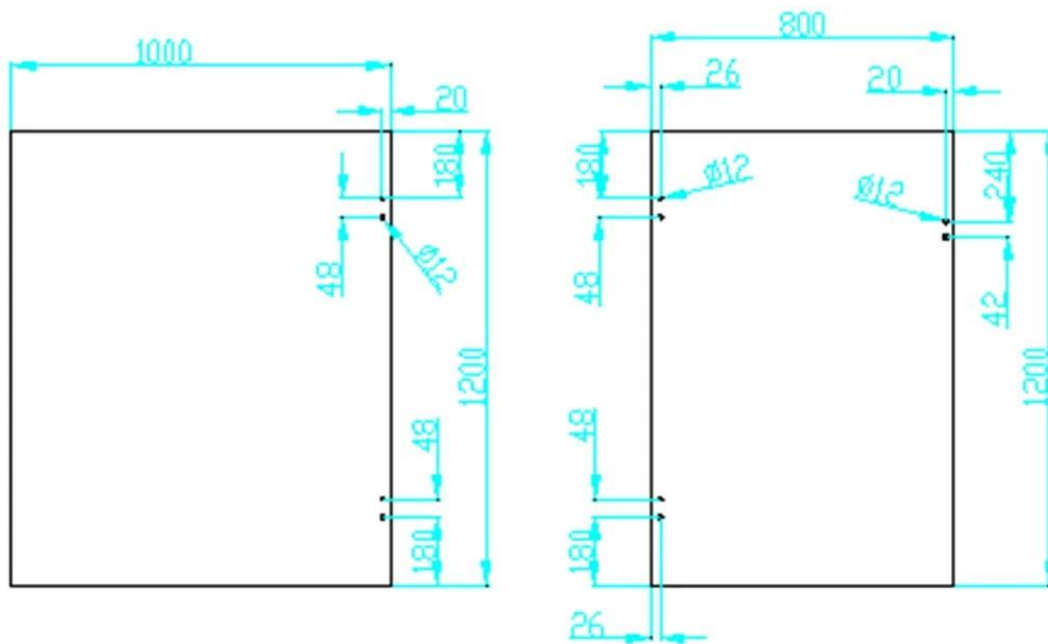

Project

Glass hinge is usually matched with [glass spigot](#) and [glass latch](#).













For more beautiful pool fence project photos, go [here](#)

Packing & Delivery

- One pc into one plastic bag, then into one box.
- Regular lead time: 10-15 days after payment. It is according to quantity.
- Shipping time: 5-7 days by express. 15-20 days by sea.

packing	plastic bag+box+carton
production lead time	30-45 days ; also depending on your qty.
Shippment	 
	   
payment	 



Factory & Certification





Need a quote or any questions? please leave a message.
Or contact me as below info. will get back to you ASAP!

KEBIL 科比奥

深圳市朗驰商贸有限公司
SHENZHEN LAUNCH CO., LTD.

朗驰国际有限公司
LAUNCH INTERNATIONAL LIMITED.

董萍 Doris Dong

Senior Sales Representative

☎ (86) 135 3050 6265

深圳市南山区南山大道1092号亿利达大厦B区3栋5003

Room 5003, Building 3, Yilida Building, No.1092
Nanshan Road, Nanshan District, Shenzhen, China
postal code 518054

☎ (86-755) 8603 7559

☎ (86-755) 8637 2611

✉ sales04@launch-china.cn

🌐 www.launch-china.com

🌐 www.chinabalustrade.com