

Stainless Steel Square Spider Baluster Post for Glass Balcony Stair Deck Railing Designs



1. Stainless Steel Square Spider Post Baluster Specifications :

Product Name	Stainless Steel Square Spider Post Baluster
Model No.	LCH-121
Material	Stainless steel 304/316
Finish	Brushed or mirror polished
Square post size	50 x 50 x 1.5mm wall thickness 40 x 40 x 1.5mm wall thickness
Height	Customizable
For glass thickness	10-15mm
Application	Balcony railing design Porch railing design Deck railing design Stair railing design

End post with 1 way spider fitting

Middle railing post with 2 way spider fitting

Standard Hight: 1100mm (customer post hights available)

Designed for 10-15mm glass or as per your requirement

Adjustable angles stand off design for staircase or balcony etc.



2. Stainless Steel Square Spider Post Dimension Drawing For your reference :

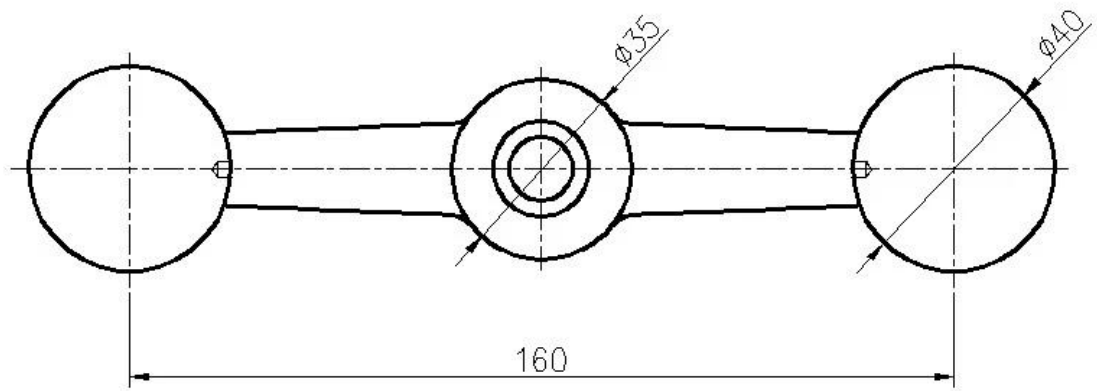
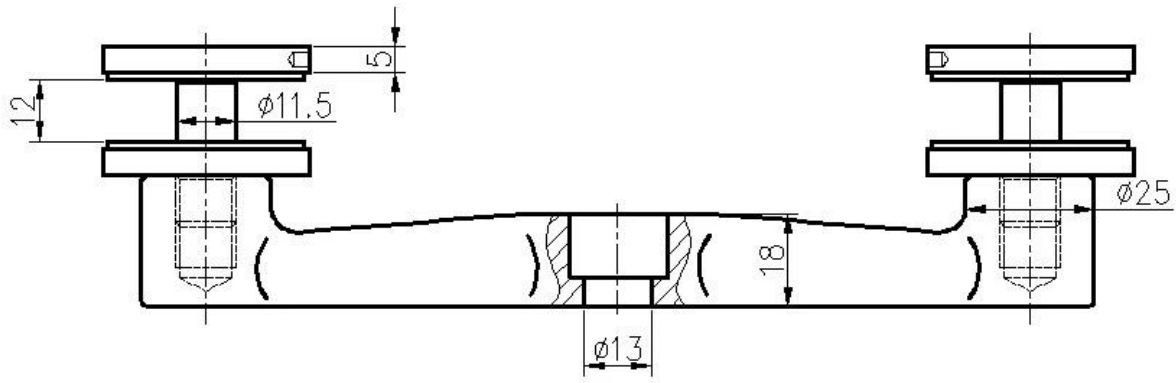

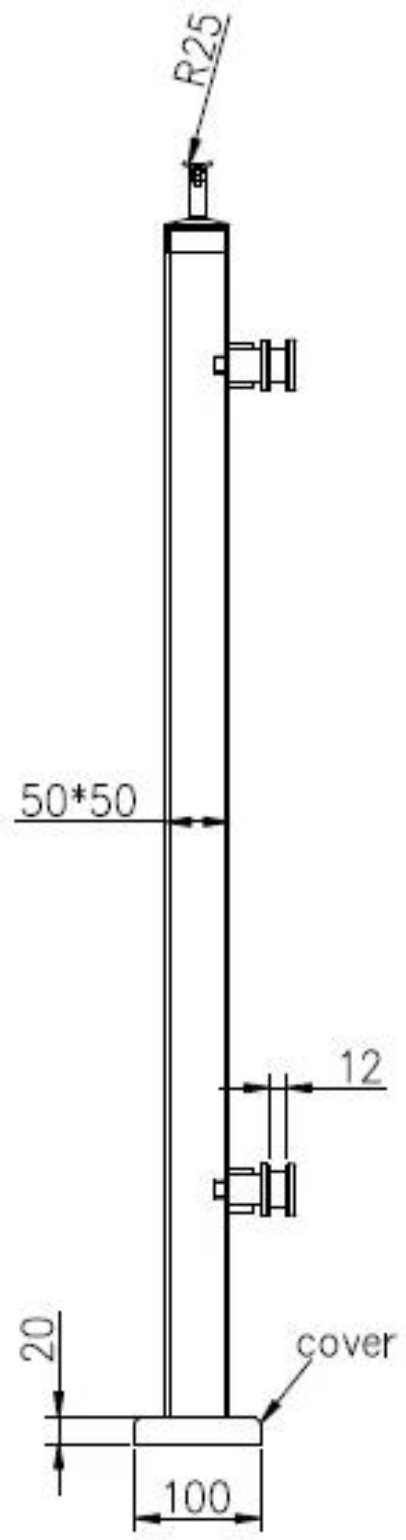
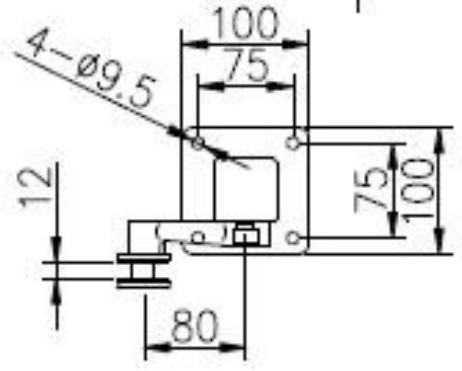
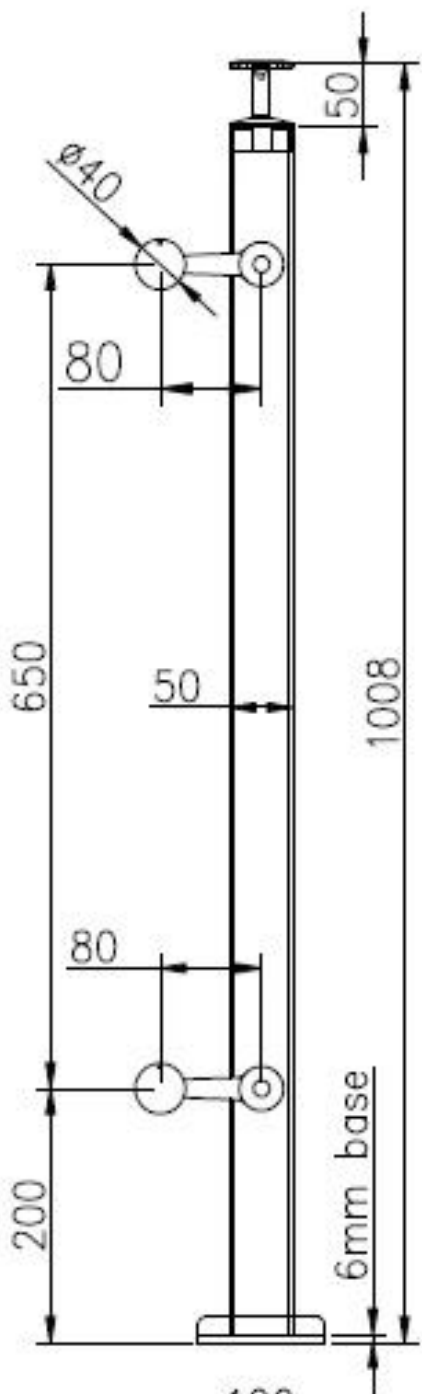

Top Adjustable Handrail Bracket for square or round tube handrail :



2 Way Intermediate Post :



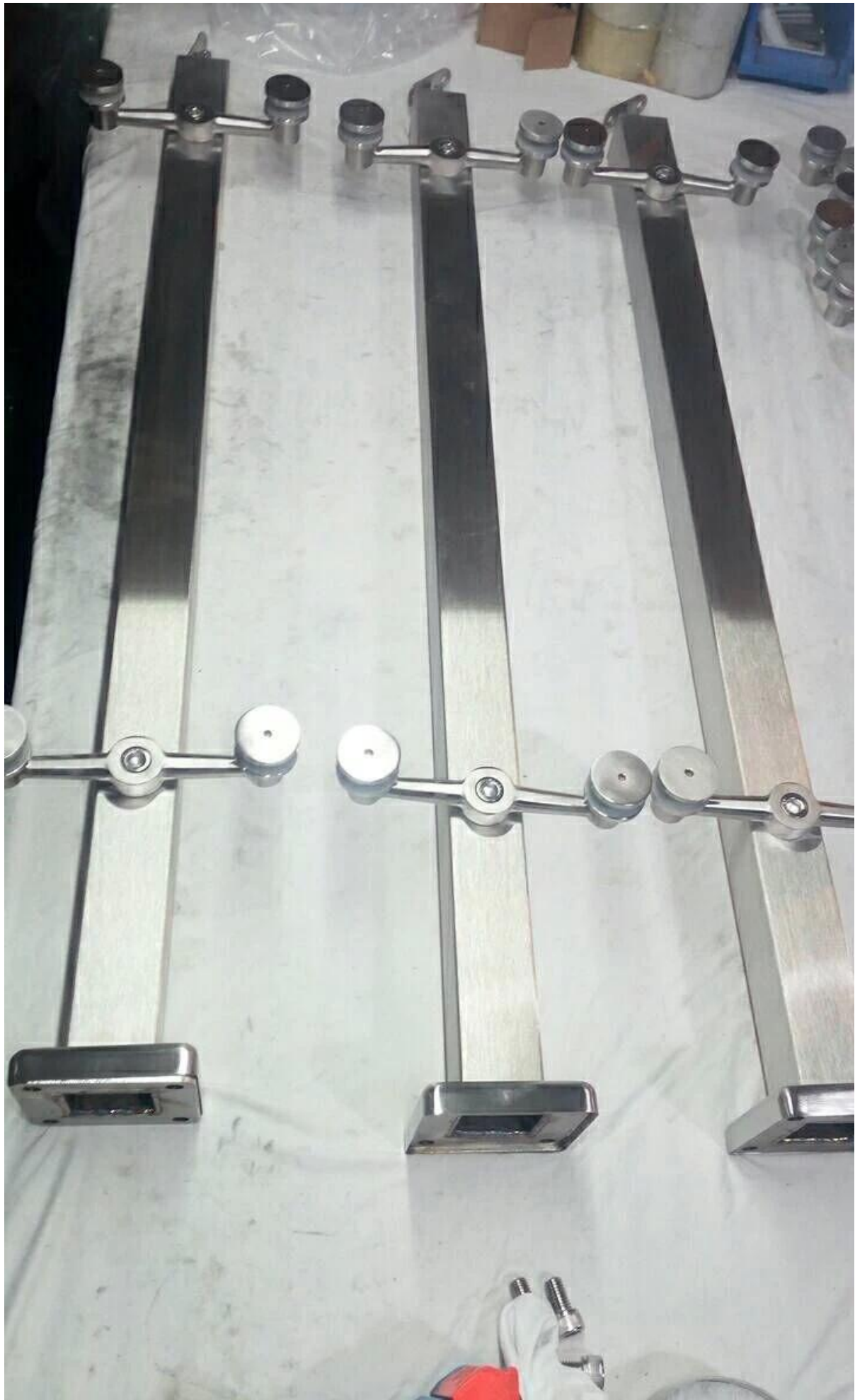

1 Way End Post :



4. Packaging Photos : 1pc/plastic bag, 2 - 4pcs/ctn.





Company Information:

Shenzhen Launch Co., Ltd was established in 2004, located at Nanshan District, Shenzhen, and one hour by car from Hongkong International Airport. Our main product is high-grade building materials includes stainless steel balustrade post, staircase handrail, balcony guardrail, swimming pool fence and other high-grade building materials. All the products are designed strictly according to the high-end market requirements. We have our own factory in Tangxia Town, Dongguan, has a variety of precision equipment more than 50 sets: CNC lathe, milling machine, punching machine, pipe cutter, argon welder, drilling machine, polisher, etc. which can provide customers with complete product processing services. With the German SPECTRO Spectrometer, we insist on testing every batch of materials to ensure that the material is highly qualified. We also have hardness gauge, secondary element and other test equipment to ensure the products meets customers' requirements.

ABOUT US



OUR ADVANTAGE

Please do not hesitate to contact us if you have any requirement regarding our production lines, you can expect a timely reply with professional solutions!



Own factory, shortest lead time.



Can help customers design product drawings based on customer ideas and design engineering installation drawing according to the customer site sketch.



Sample order, trial order acceptable.



Provide material test report to ensure that the material is qualified.



13 years of industry experience, we can help customers recommend the best solution to help customers save cost.

OUR FACTORY

More than 13 years experience in hardware industry design and processing, we can provide customized services from design to the sample and small batch trial production.



OUR CERTIFICATE

With premium quality, competitive price and superior service, we won a lot of customers' favor.
Our products are popular in North America, European and Australia.



PRODUCTION PROCESS



Casting



CNC lathe



CNC Milling



Stamping



Drilling & Tapping



Polishing



PACKAGING & DELIVERY



PAYMENT & TRANSPORTATION

Welcome Alibaba Trade Assurance Order!

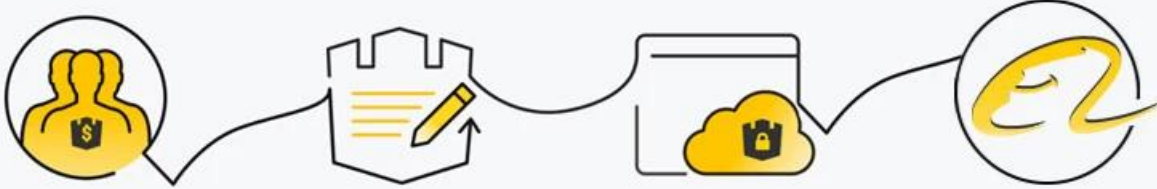

1 Start an order

2 Negotiate terms with our sales service & confirm order

3 Make payment

4 Alibaba provide full assurance



Please contact us freely for more information:

Email: sales03@launch-china.cn

Contact: Eve Chow

HP/WhatsApp/WeChat: +8613686807796