

1.Description

不锈钢扶手 不锈钢立柱 不锈钢扶手带 bandrail 不锈钢扶手 / 不锈钢立柱

2.Products تفاصيل

S

STAINLESS STEEL BALUSTRADE AND FITTINGS

KEBIL 科比奥 SHENZHEN LAUNCH CO., LTD

http://www.chinabalustrade.com

STAND OFF



SF-30

Model No. : SF-30	
Material	Stainless steel 304/316
Finish	Satin / mirror polished
Size	30*15mm cap, 30*25mm body, M3*110 bolt, silicon rubber gasket included



SF-50

Model No. : SF-50	
Material	Stainless steel 304/316
Finish	Satin / mirror polished
Size	50*15mm cap, 50*30mm body, M3*120 bolt, silicon rubber gasket included



SF-30T

Model No. : SF-30 T	
Material	Stainless steel 304/316
Finish	Satin / mirror polished
Size	50*15mm cap, 50*30mm body, silicon rubber gasket included
Mounting plate size	290*190*15mm

HANDRAIL BRACKET



P701

Model No. : P701	
Material	Stainless steel 304/316
Finish	Satin / mirror polished



P701R

Model No. : P701R	
Material	Stainless steel 304/316
Finish	Satin / mirror polished



P702

Model No. : P702	
Material	Stainless steel 304/316
Finish	Satin / mirror polished



P702R

Model No. : P702R	
Material	Stainless steel 304/316
Finish	Satin / mirror polished



P703

Model No. : P703	
Material	Stainless steel 304/316
Finish	Satin / mirror polished



P703R

Model No. : P703R	
Material	Stainless steel 304/316
Finish	Satin / mirror polished



P704

Model No. : P704	
Material	Stainless steel 304/316
Finish	Satin / mirror polished



P705

Model No. : P705	
Material	Stainless steel 304/316
Finish	Satin / mirror polished



P706

Model No. : P706	
Material	Stainless steel 304/316
Finish	Satin / mirror polished



P707

Model No. : P707	
Material	Stainless steel 304/316
Finish	Satin / mirror polished



P708

Model No. : P708	
Material	Stainless steel 304/316
Finish	Satin / mirror polished



P709

Model No. : P709	
Material	Stainless steel 304/316
Finish	Satin / mirror polished







SX-7001D

564 g
lb
oz
s

NET
PCS

UNIT

ON/OFF

ZERO
TARE

TOWE

Electronic Compact Scale

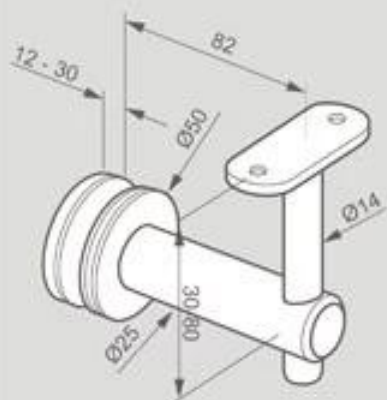



Project. عرض 3













أمیر؛ خدمه توصیل & 4.Packaging





packing	plastic bag+box+carton	
production lead time	30-45 days ; also depending on your qty.	
Shipment		
		
		
payment		 <small>FAST, RELIABLE, WORLDWIDE MONEY TRANSFER</small>

5.Factory



production process

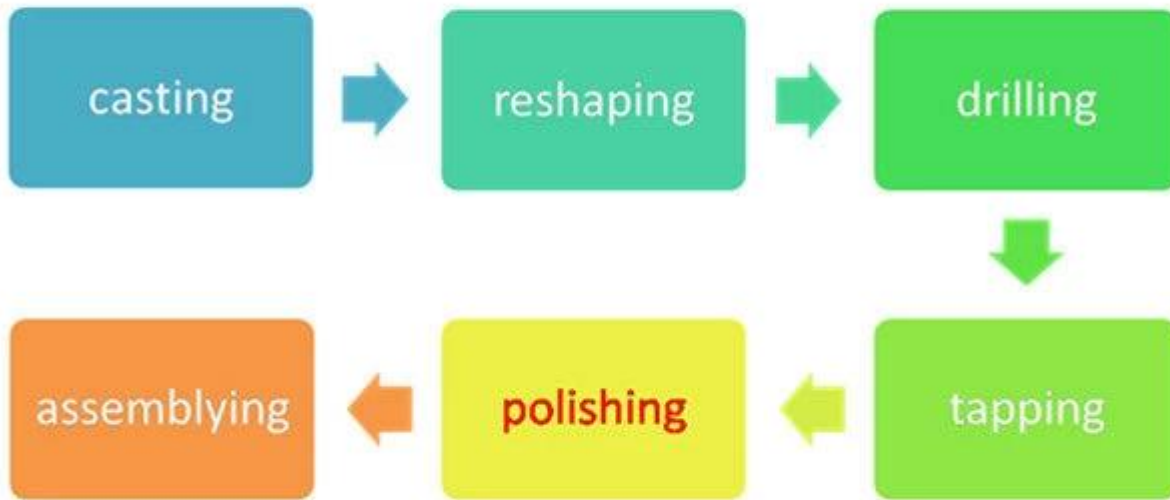

6.Certifaction

ISO 
9001:2008
R E G I S T E R E D

KEBIL 科比奥®

深圳市朗驰商贸有限公司
SHENZHEN LAUNCH CO., LTD.

朗驰国际有限公司
LAUNCH INTERNATIONAL LIMITED.

董萍 Doris Dong

Senior Sales Representative

☎ (86) 135 3050 6265

深圳市南山区南山大道1092号亿利达大厦B区3栋5003

Room 5003, Building 3, Yilida Building, No.1092
Nanshan Road, Nanshan District, Shenzhen, China
postal code 518054

☎ (86-755) 8603 7559

☎ (86-755) 8637 2611

✉ sales04@launch-china.cn

🌐 www.launch-china.com

www.chinabalustrade.com

!شكرا لكم لزيارة. يرجى الاتصال بنا للحصول على سعر المصنع مباشرة والمهنية ينصح