

□□□□□□□□

□□□□□□ □□□	□□□□ □□□□□□ □□□□□□□□
□□□□□	304SS / 316SS / □□□□□□□□□□□□
□□□□□□ □□□	□□□□□ / □□□□□ / □□□□□□□□
□□□□□□ □□□	10-16mm.
□□□□	□□□□□□ □□□□□□□□ □□□□□□□□ □□□□□ □□□□□ □□□□□

□□□□ □□□□□□ □□□□□□□□

Balustrade Short Post



Aluminum post
(aluminum 6063 T5)

- *400mm hight
- *50x50x3mm tube
- *50x5mm plate

Finish:
anodizing
powder coating



Stainless steel post
(SS 316)

- *400mm hight
- *50x50x1.5mm tube
- *50x5mm plate

Finish:
polished
brushed



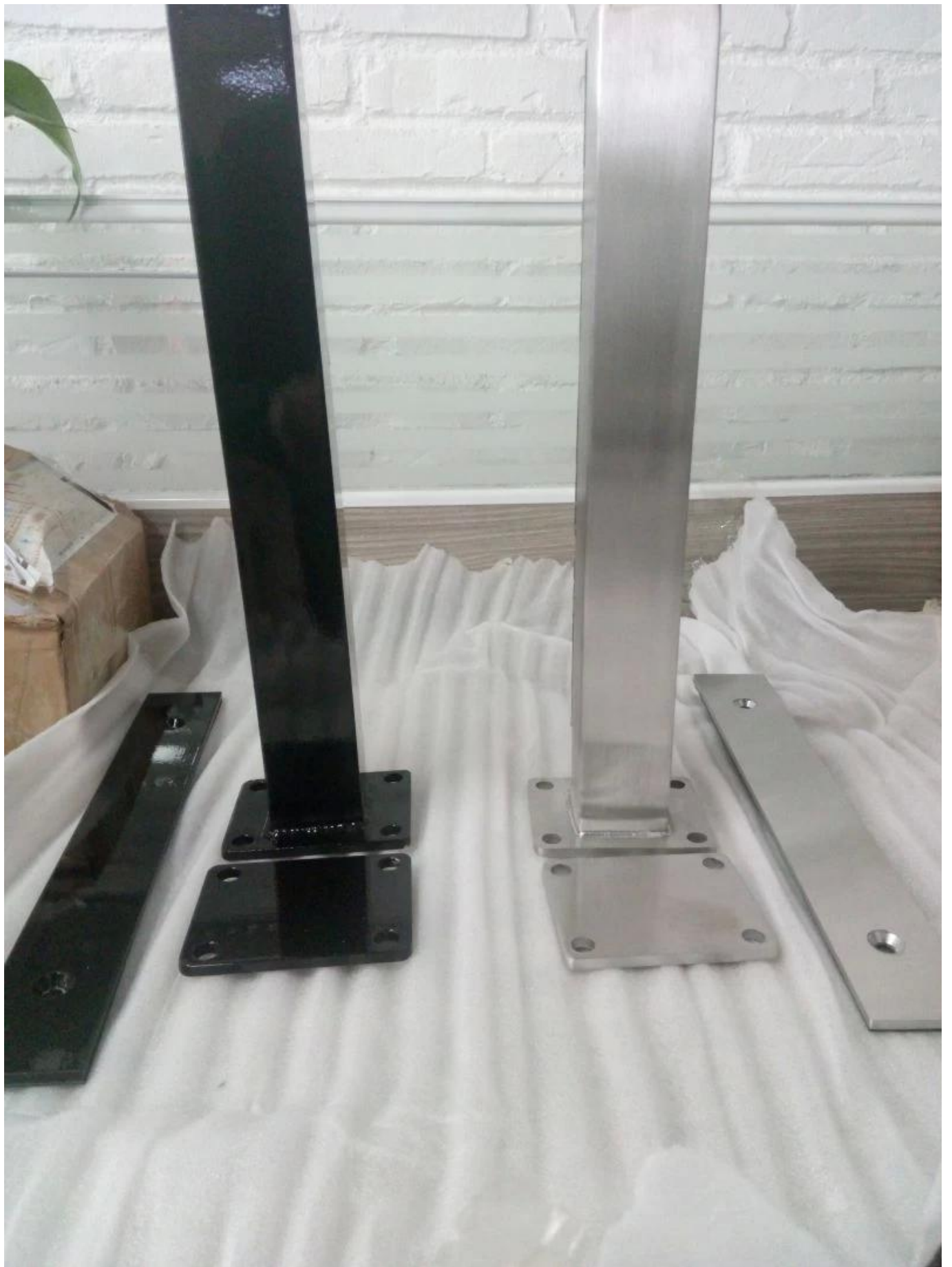





□□□□ □□□□□□ □□□□□□ □□□□□□ □□□□□□







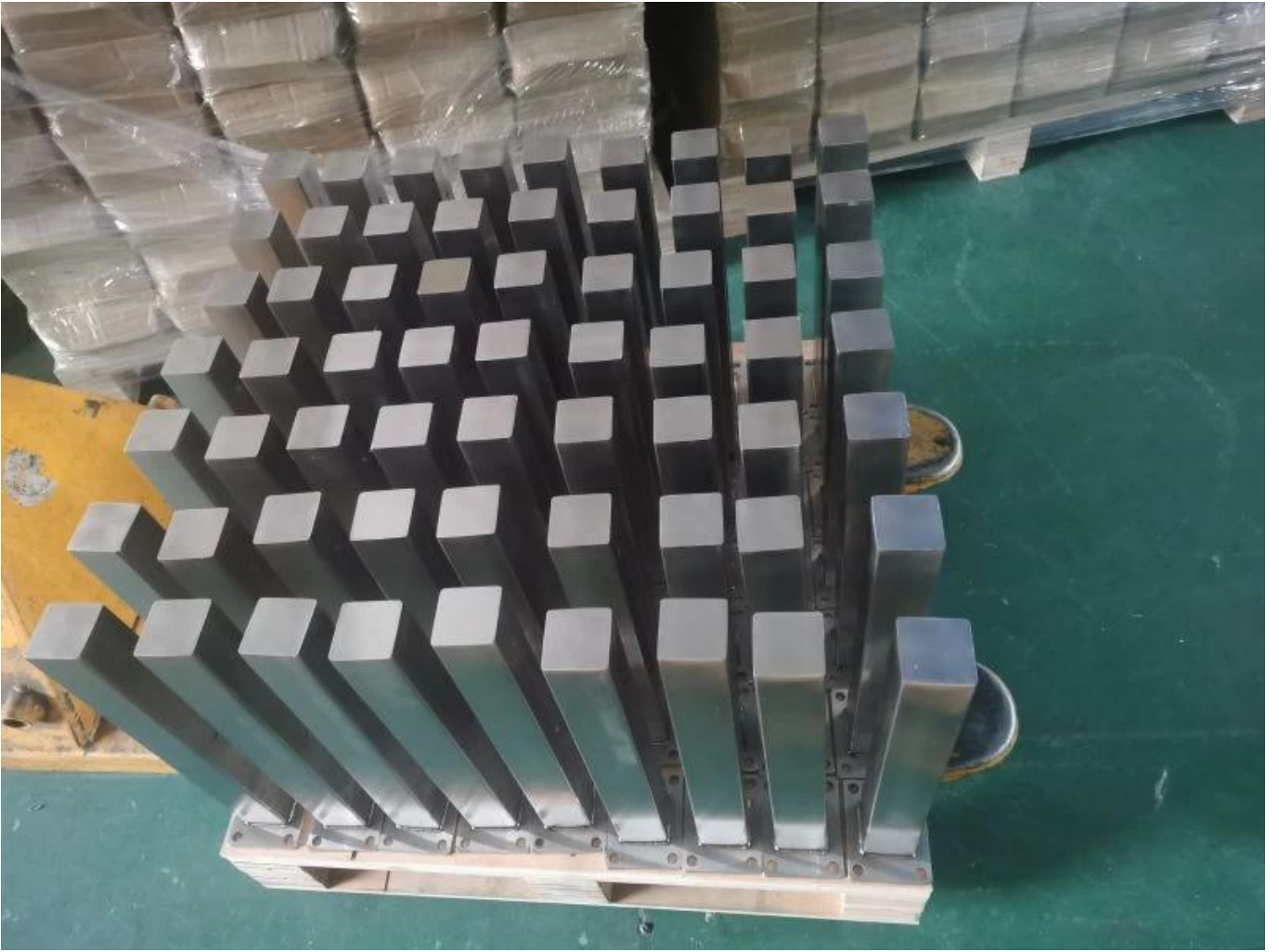

□□ □□

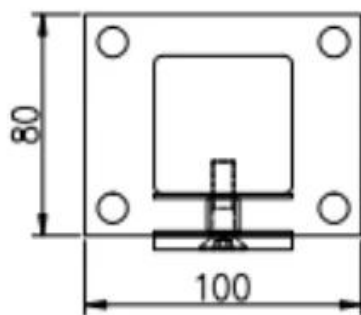
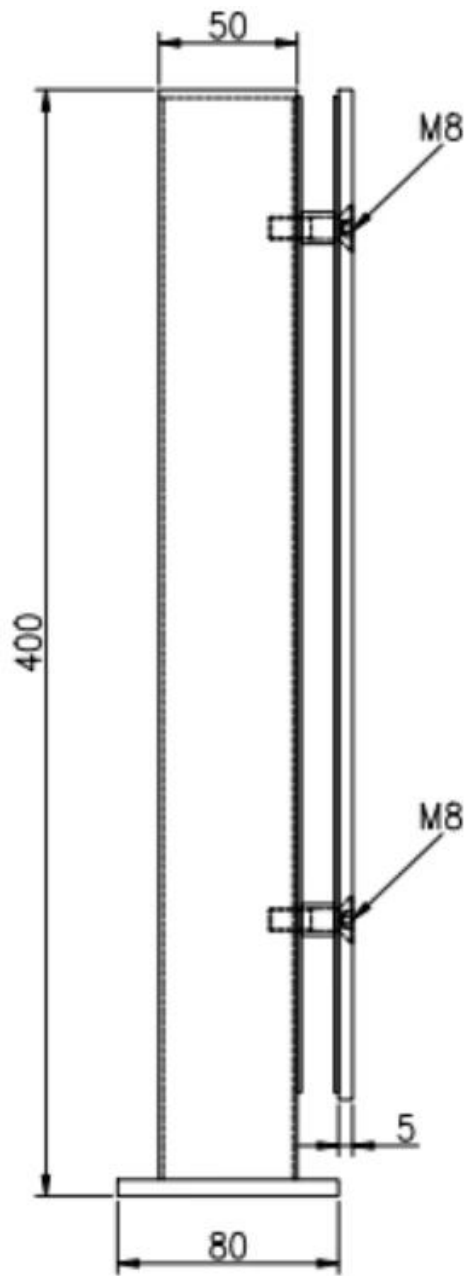
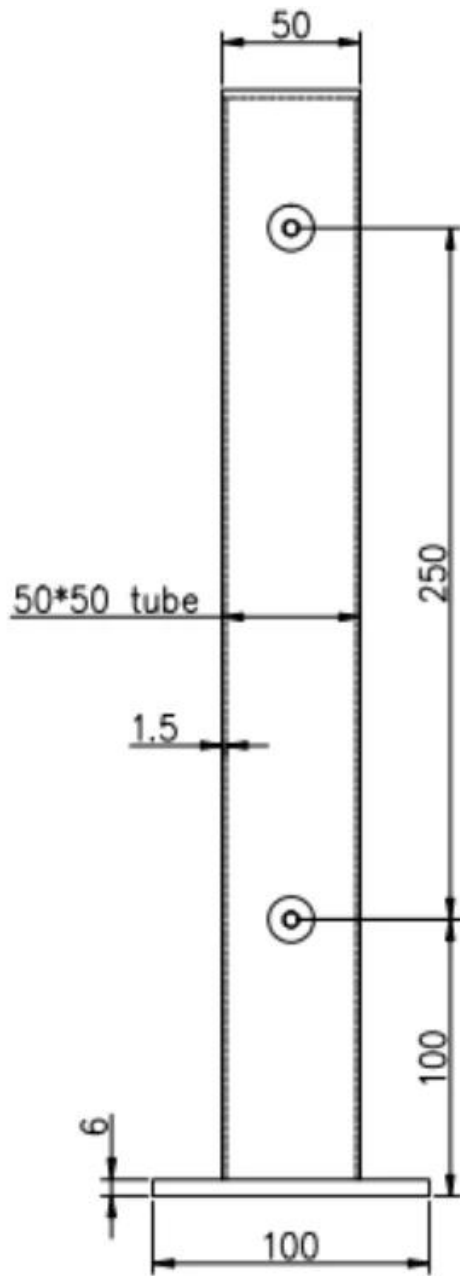

□□□□ □□□□□□ □□ □□

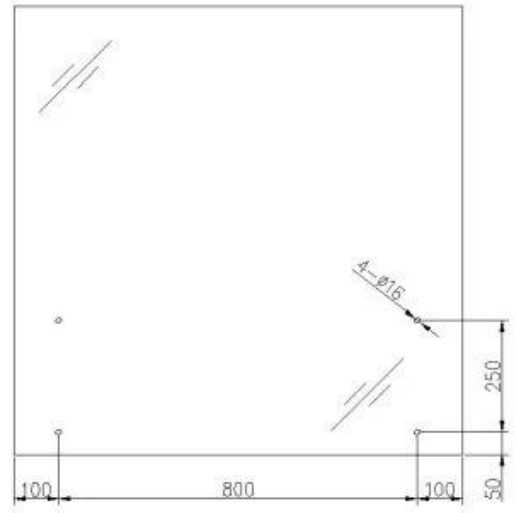
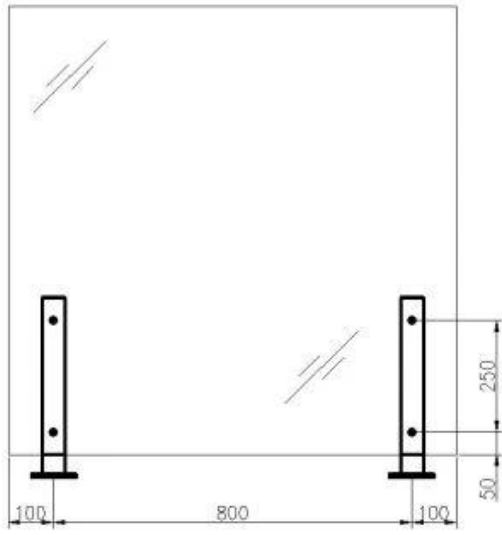

□□□□□□ □□□□







上海朗坤金属制品有限公司
销售热线：sales02@launch-china.cn

☐☐☐☐☐ / Whatsapp / Wechat: +86 159 0626 1741