





□□□□ □□□



□□□□□□ □□





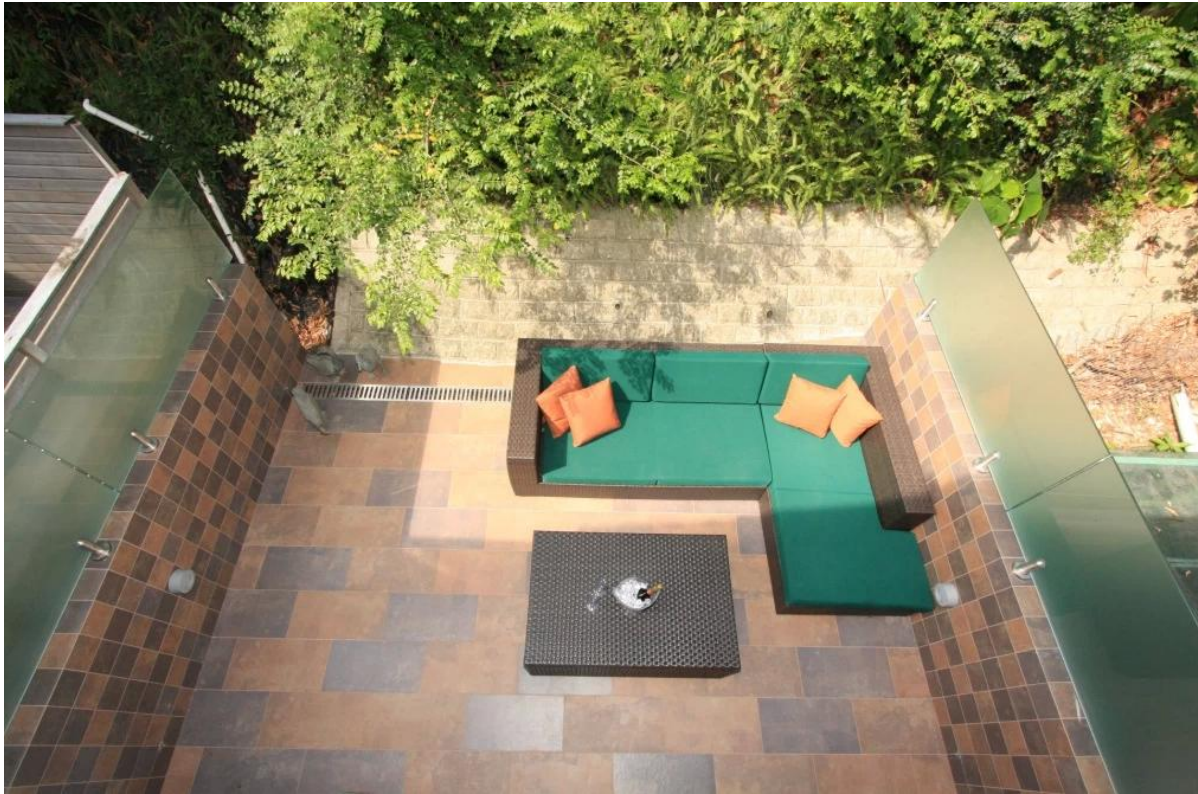

XXXXXXXXXXXXXXXXXXXX,XXXXXXXXXXXXXXXXXXXX,XXXXXXXXXXXXXXXXXXXX:XXXX XXXXXXXXXXXXXXX XXXXXXXXXXXXXXX

XXXX XXXXXXX XXXXXXXXXXXXXXX XXXXXXXXXXXXXXX XXXXXXXXXXXXXXX XXX XXXXXXX XXX XXXXXXXXXXXXXXX

XXXX XXXXXXXXXXXXXXX XXXXXXXXXXXXXXX

Results Summary  
 (For details of individual tests, refer to the tables on the following pages.)

ID	Item/Heat No.	Dimensions/Type/Details	Finish	Overall Assessment
14117/01	SSBM316	180mm High, 50mm Square, Base Plate 316 Stainless steel	316L	COMPLIES

Remarks

After completion of the testing, the spigot was found to be in sound condition with no breakage, tearing or signs of fracture and no looseness of the fixings.

Colin Lorrimar  
 Metallurgical Testing Manager



Accreditation No.   
 Accredited for compliance  
 with ISO/IEC 17025

XXXXXXXXXXXX

Project name

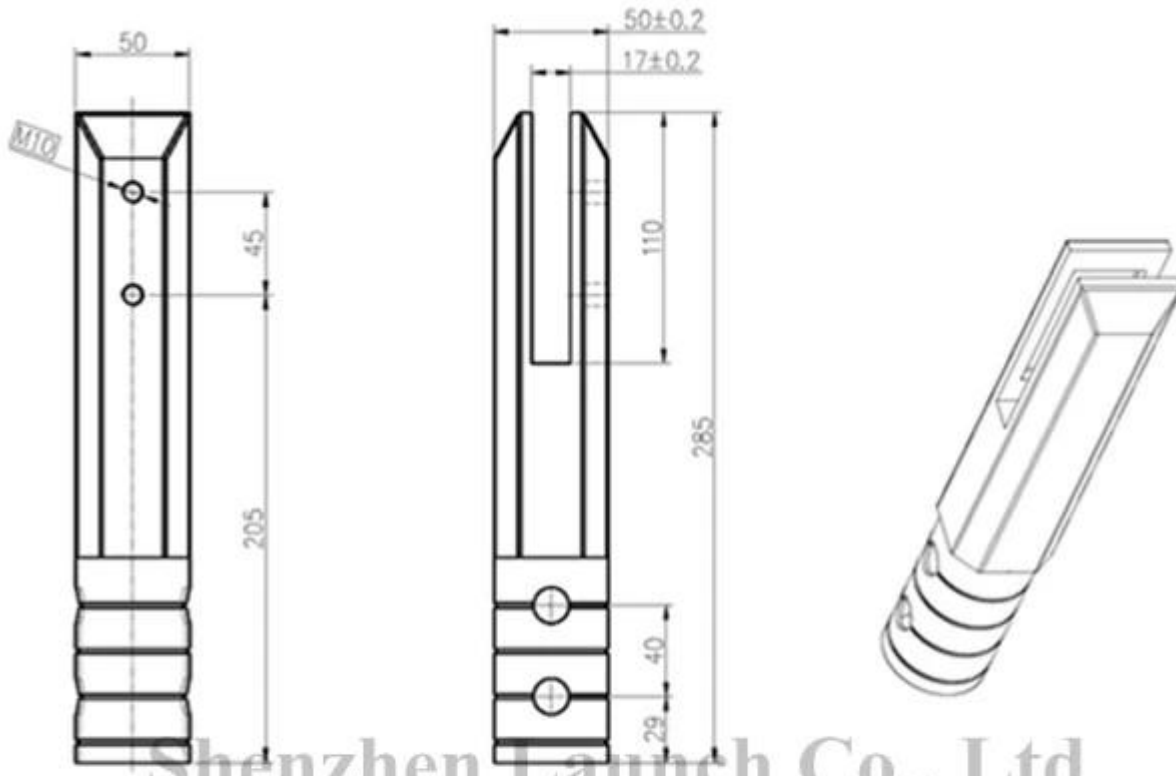

Shenzhen Launch Co., Ltd

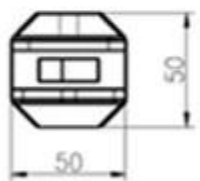









数量共页第页

<b>深圳市朝福商贸有限公司</b> <b>SHENZHEN LAUNCH CO., LTD.</b>		表面处理
设计	裴佳辉	材料
校对		未
工艺	图号:SCM	线性公差
审核	名称:Spigot	角度公差
批准	版次 Y001	

朝福商贸有限公司 朝福商贸有限公司  
 -Pc 朝福商贸有限公司 朝福商贸有限公司 20 .朝福商贸有限公司 朝福商贸有限公司 朝福商贸有限公司 朝福商贸有限公司  
 -朝福商贸有限公司 5-3) 朝福商贸有限公司/(朝福商贸有限公司 15-10) 朝福商贸有限公司 朝福商贸有限公司 :朝福商贸有限公司 朝福商贸有限公司)





packing	plastic bag+box+carton
production lead time	30-45 days ; also depending on your qty.
Shippment	 
	 
	 
payment	 

□□□□□□□□ □□□□□□ □□□□





**KEBIL** 科比奥™

**ISO**  
**9001:2008**  
REGISTERED

**Factory Audit**



[www.launch-china.cn](http://www.launch-china.cn)



# Shenzhen Launch Co.,Ltd



[www.launch-china.cn](http://www.launch-china.cn)

□□□□ □□ □□□□ □□□□ □□ □□ □□□□ □□ □□ □□□□.

□□□□ □□ □□□□ □□ □□□□ □□□□ □□□□ □□ □□ □□□□ □□!





深圳市朗驰商贸有限公司  
SHENZHEN LAUNCH CO., LTD.

朗驰国际有限公司  
LAUNCH INTERNATIONAL LIMITED.

**董 萍** Doris Dong

Senior Sales Representative

☎ (86) 135 3050 6265

---

深圳市南山区南山大道1092号亿利达大厦B区3栋5003

Room 5003, Building 3, Yilida Building, No.1092  
Nanshan Road, Nanshan District, Shenzhen, China  
postal code 518054

---

☎ (86-755) 8603 7559

☎ (86-755) 8637 2611

✉ sales04@launch-china.cn

🌐 www.launch-china.com

www.chinabalustrade.com