

الفولاذ المقاوم للصدأ الزجاج العنكبوت المناسب الزجاج الستارة تركيب
الزجاج حديدي العنكبوت المناسب





1. الفولاذ المقاوم للصدأ ساحة العنكبوت بعد الدوران المواصفات :

المنتج اسم	الفولاذ المقاوم للصدأ ساحة العنكبوت الدور الدائري
نموذج رقم:	LCH-121
مواد	الفولاذ المقاوم للصدأ 304/316
إنهاء	نحى أو مرآة مصقولة
حجم مربع آخر	سمك 1.5 × 50 × 50 مم سمك 1.5 × 40 × 40 مم
ارتفاع	تخصيص
لسمك الزجاج	10-15mm
الوضعية	تصميم حواجز الشرفة تصميم حديدي الشرفة تصميم حديدي سطح السفينة درج تصميم حديدي



2. الفولاذ المقاوم للصدأ لساحة العنكبوت بعد البعد الرسم للرجوع اليها.

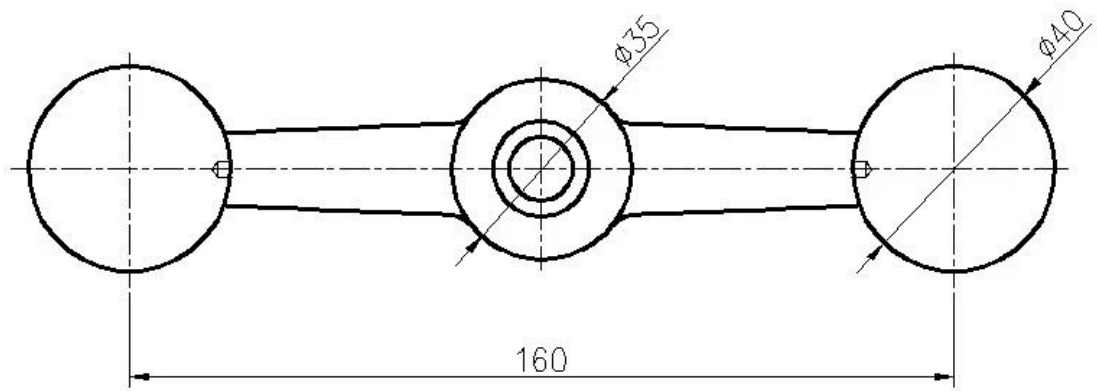
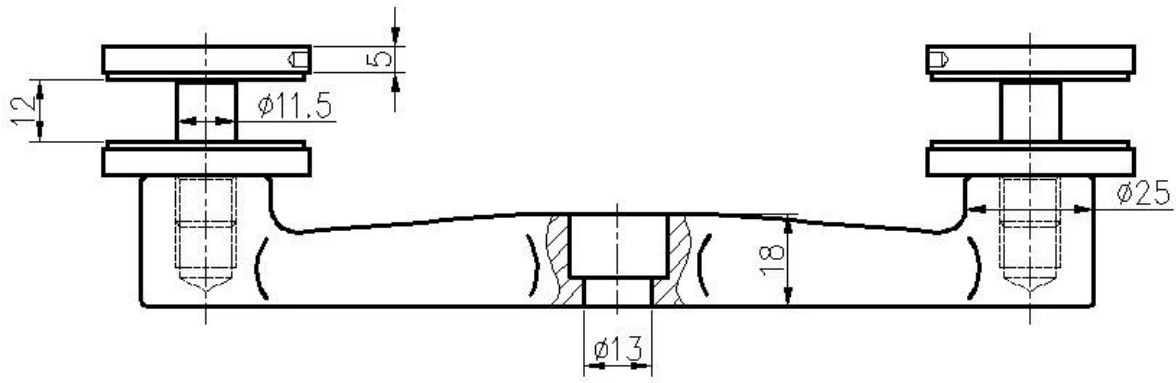

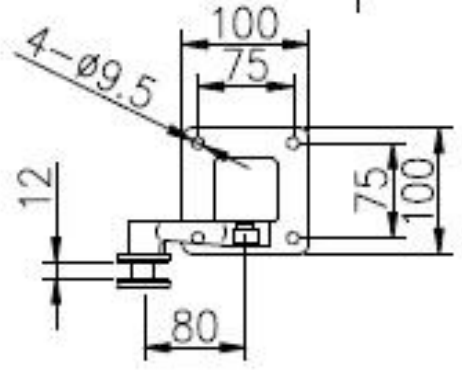
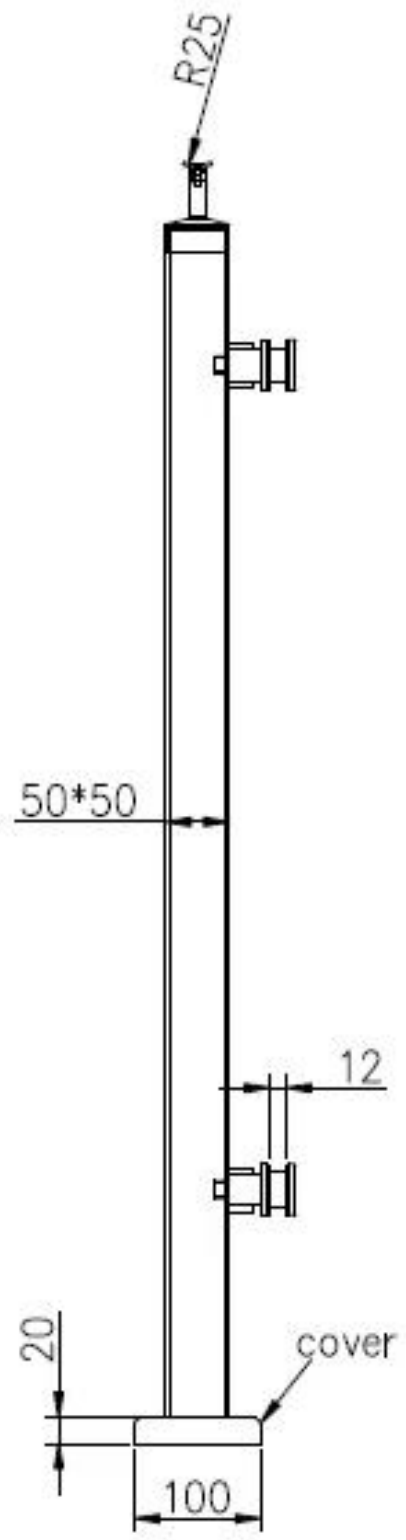
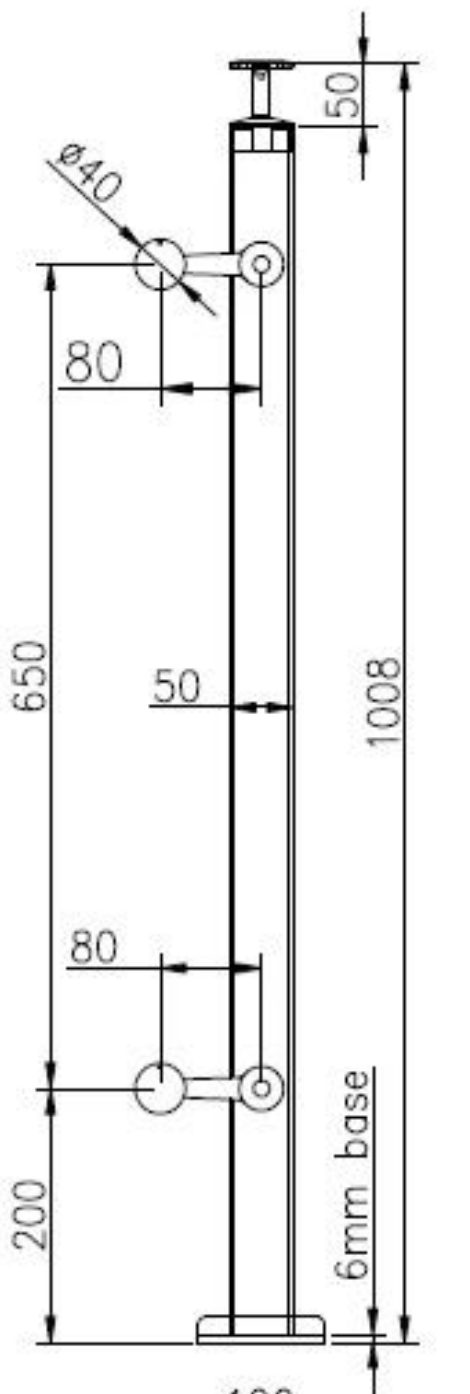

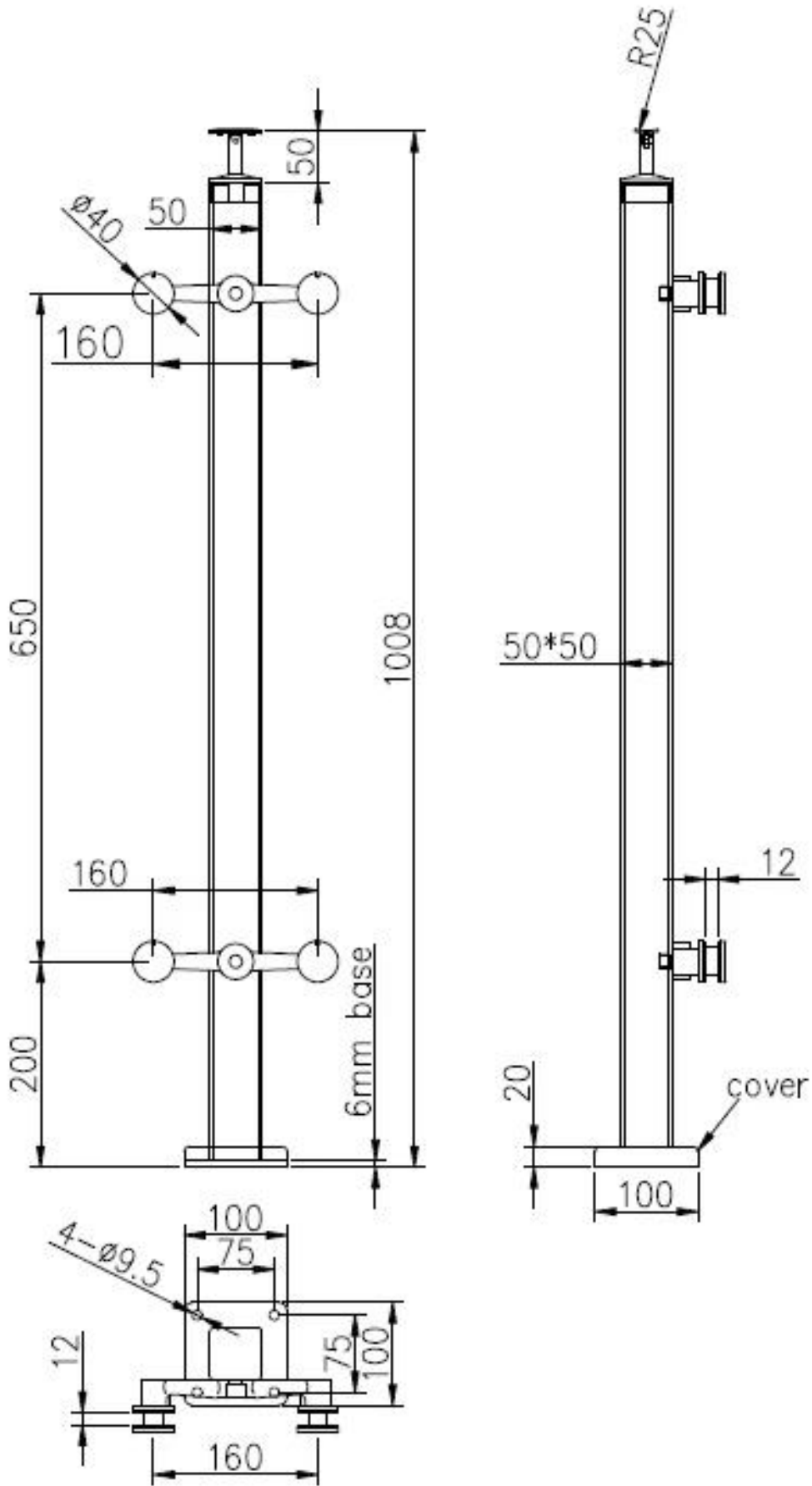

3. الفولاذ المقاوم للصدأ درايزين درايزين بوست صور:
 أعلى قوس درايزين قابل للتعديل للدرايزين مربع او جولة الدرايزين



طريقة الوسيطة 2 الطريق



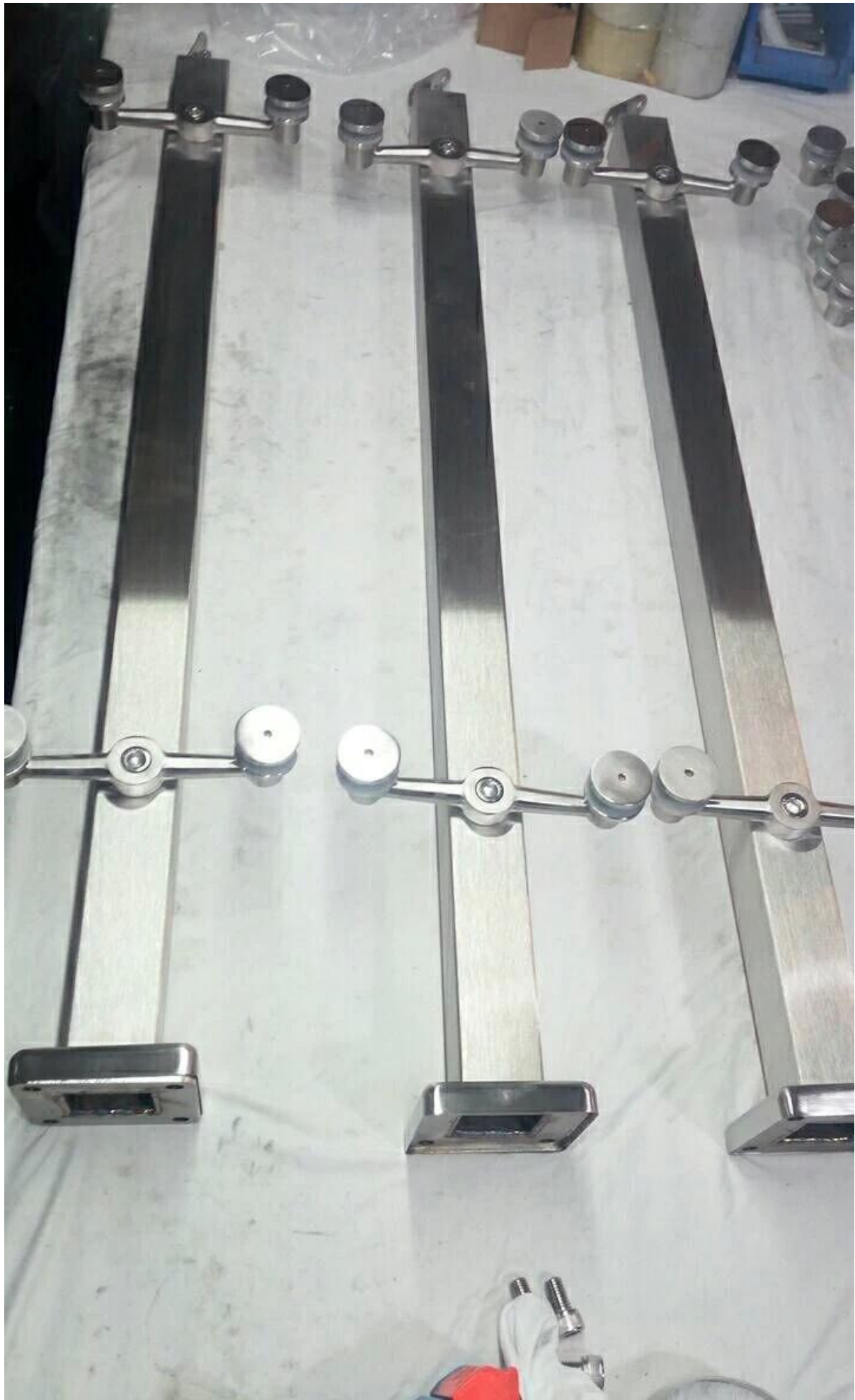

طريقة واحدة للنهاية:



4. 1 صور التغليف: 2 - 4 / pcs من البلاستيك ، 2 - 4 / pcs صور التغليف: 1.





أنواع أخرى من التجهيزات العنكبوت
تركيب عنكبوت الفولاذ المقاوم للصدأ للجدار الساتر -

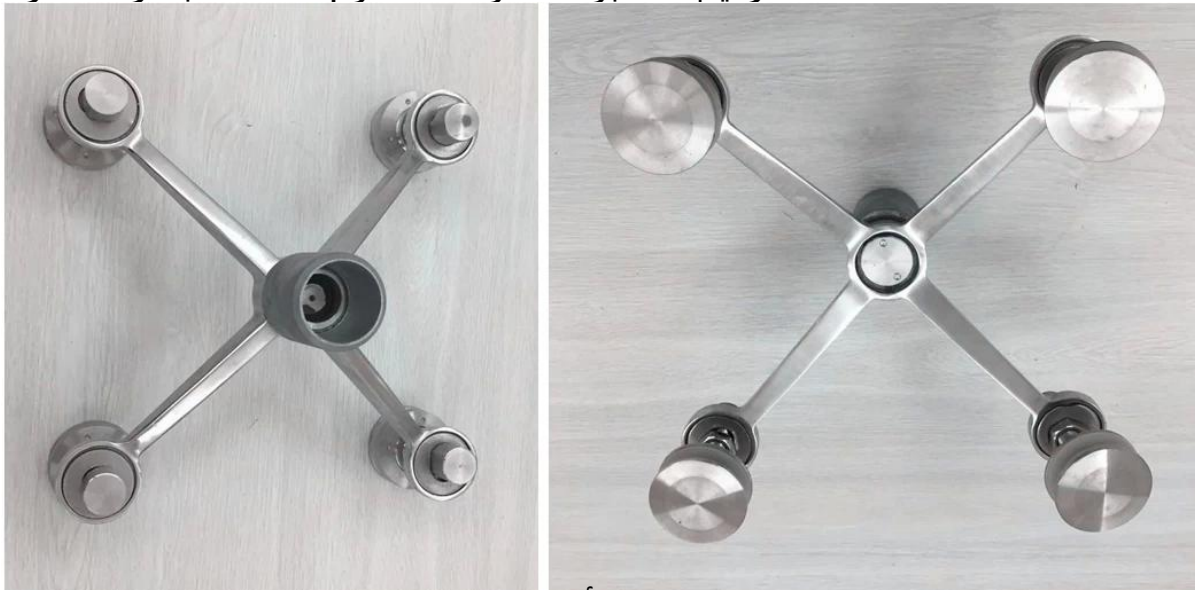

العنكبوت لأنظمة الدرايزين الزجاجي OEM تركيب -

KEBIL 科比奥®



شركة معلومات:

Shenzhen Launch Co., Ltd was established in 2004, located at Nanshan District, Shenzhen, and one hour by car from Hongkong International Airport. Our main product is high-grade building materials includes stainless steel balustrade post, staircase handrail, balcony guardrail, swimming pool fence and other high-grade building materials. All the products are designed strictly according to the high-end market requirements. We have our own factory in Tangxia Town, Dongguan, has a variety of precision equipment more than 50 sets: CNC lathe, milling machine, punching machine, pipe cutter, argon welder, drilling machine, polisher, etc. which can provide customers with complete product processing services. With the German SPECTRO Spectrometer, we insist on testing every batch of materials to ensure that the material is highly qualified. We also have hardness gauge, secondary element and other test equipment to ensure the products meets customers' requirements.

ABOUT US

Our Team



OUR ADVANTAGE

Please do not hesitate to contact us if you have any requirement regarding our production lines, you can expect a timely reply with professional solutions!



Own factory, shortest lead time.



Can help customers design product drawings based on customer ideas and design engineering installation drawing according to the customer site sketch.



Sample order, trial order acceptable.



Provide material test report to ensure that the material is qualified.



13 years of industry experience, we can help customers recommend the best solution to help customers save cost.

OUR FACTORY

More than 13 years experience in hardware industry design and processing, we can provide customized services from design to the sample and small batch trial production.



OUR CERTIFICATE

With premium quality, competitive price and superior service, we won a lot of customers' favor.
Our products are popular in North America, European and Australia.



PRODUCTION PROCESS



Casting



CNC lathe



CNC Milling



Stamping



Drilling & Tapping



Polishing



PACKAGING & DELIVERY



PAYMENT & TRANSPORTATION

Welcome Alibaba Trade Assurance Order!

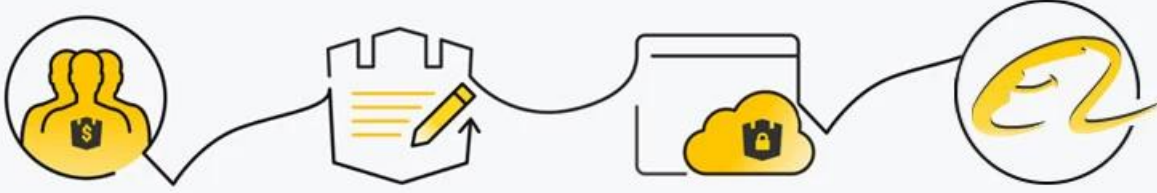

1 Start an order

2 Negotiate terms with our sales service & confirm order

3 Make payment

4 Alibaba provide full assurance



يرجى الاتصال بنا بحرية لمزيد من المعلومات
البريد الإلكتروني: sales03@launch-china.cn
الاتصال: حواء تشاو
WhatsApp / HP: +8615907334556