

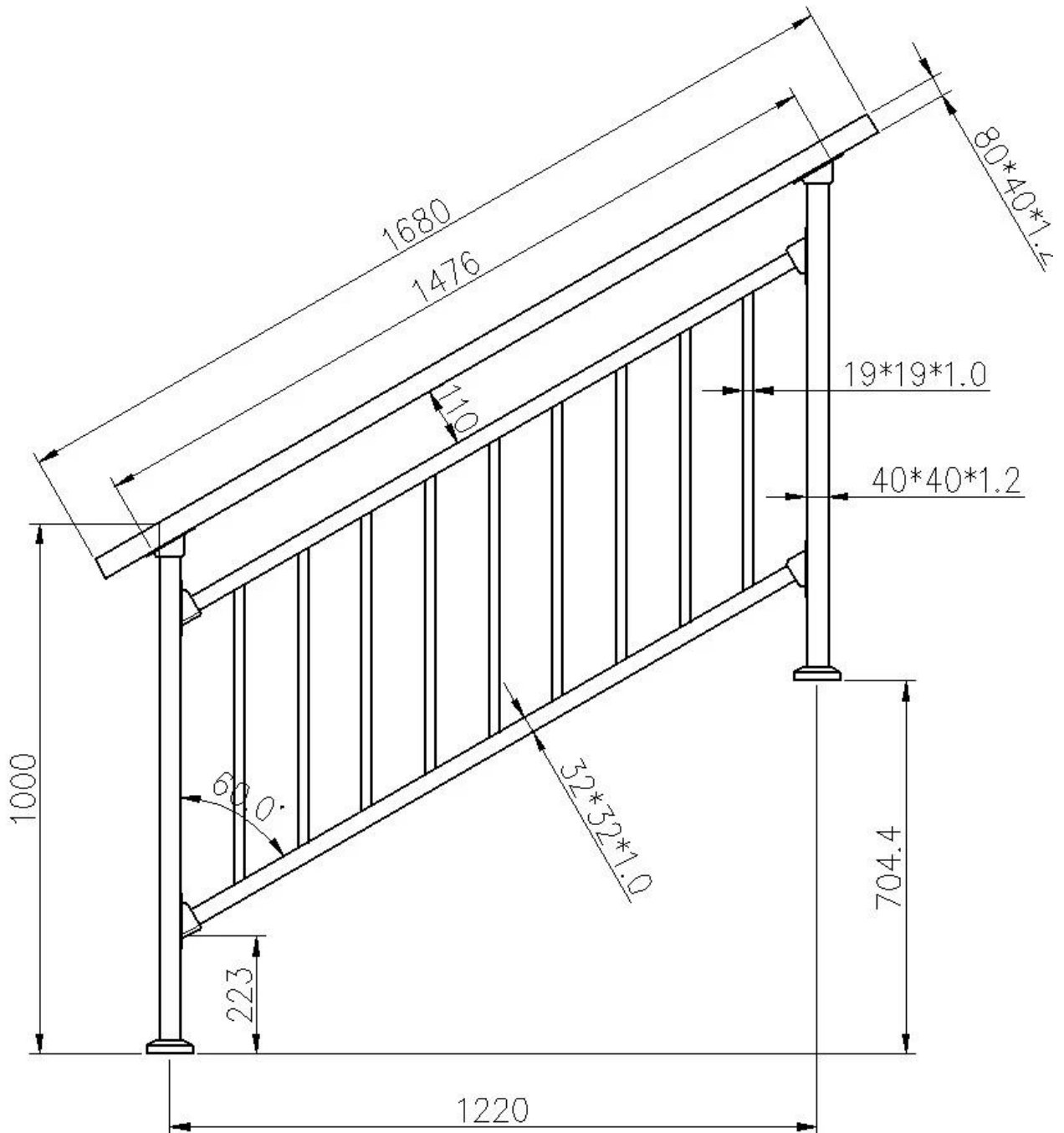





























Für Innen- / Außentreppen, die auf Stufen montiert sind.

1). Eigenschaften von Stahlgeländern-

- Hauptpfosten 40 * 40mm
- Oberer Handlauf 80 * 40mm
- vertikale kleine Schienen 19 * 19mm
- Untere Schiene und obere horizontale Schiene 32 * 32 mm



Weitere Dimensionen zur Auswahl wie folgt:

Item	Specs.	Shape	Remark	Item	Specs.	Shape	Remark	Item	Specs. (mm)	Shape	Remark
Handrail (mm)	80x40		optional	Main Post	40x40 50x50		optional	Connector (middle/bottom rail to post)	32x32 40x40 40x30 50x50		optional
	60x30			Middle/Bottom rail	32x32 35x35 40x40 45x45			water-proof sleeves (for small vertical post)	19x19 16x16 22x22 25x25		
	70x30				40x30				25x12 28x20		
	93x45			Small vertical post	19x19 16x16 22x22 25x25			Rivet screw	M6x15		
	80x40				25x12			corner connector (handrail to handrail to post)	80x40/40		
	80x40				28x20			T shape connector	80x40/40		
	60x40				25x18			post to handrail connector	80x40		
	60x60				Φ22			Handrail connection cover	80x40		
	50x50			Middle/Bottom slot rail	32x32 35x35			Main post base plate	40x40		
	60x40				40x30			Main post base cover	40x40		
								handrail cap	80x40		

2). Detaillierte Fotos von Custom Steel Ornamental Handläufe Schmiedeeisen Handlauf-















Auf Treppen installiert -





Produktionsfotos in unserer Werkstatt-









