

**Werks-Aluminiumprofil-U-Kanal, Aluminium-Glaskanal für BalkonterrasseDeck
Metallgeländer-Konstruktionssysteme**



Spezifikationen für Aluminiumglasgeländer:

EISENBAHNTEIL - KELLER	MATERIAL	ABMESSUNG (MM)	OBERFLÄCHE BEENDET	ANZUGSGLASDICKE (MM)
U-Kanal / U-Profil	Aluminium A.lloy	102 * 62	Eloxal- / Sprühfarbe	12-13.52
		102 * 67		8 + 1,52 + 8
		102 * 70,5		10 + 1,52 + 10
Innensystem & Schraube	3 oder 4 Meter pro Länge			

Verkleidung	SUS 304 / SUS 316	102	Gebürstet / Spiegel	/.
Gummi	Plastik	Verschiedene	Schwarz	Alles





Aluminium Base U-Profil für Glasgeländer-Balustrade in Schwarz Farbe:



Verfügbare Modelle:

LCH-A01 / A02: ohne / mit Verkleidung zur Verwendung mit 20 mm bis 21,52 mm Glas

LCH-A01



20 mm to 21.52 mm tempered glass

1 m aluminium groove contains the following accessories (excluding glass)

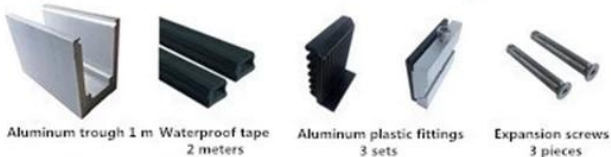

LCH-A02



20 mm to 21.52 mm tempered glass

1 m aluminium groove contains the following accessories (excluding glass)

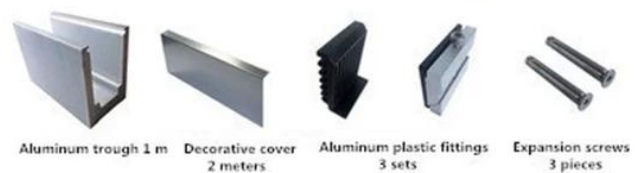

LCH-B01 / A02: ohne / mit Verkleidung zur Verwendung mit 16 mm bis 17,52 mm Glas

LCH-B01

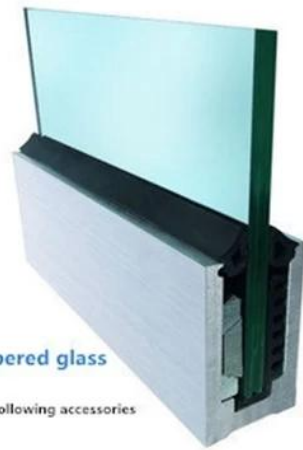

16 mm to 17.52 mm tempered glass

1 m aluminium groove contains the following accessories (excluding glass)



LCH-B02



16 mm to 17.52 mm tempered glass

1 m aluminium groove contains the following accessories (excluding glass)



LCH-C01 / A02: ohne / mit Verkleidung zur Verwendung mit 12 mm bis 13,14 mm Glas

LCH-C01

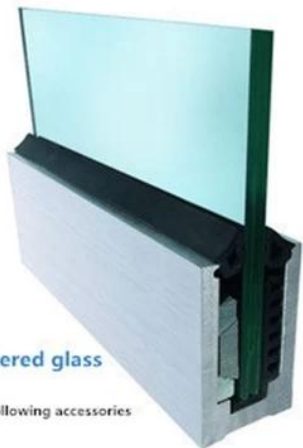

12 mm to 13.14 mm tempered glass

1 m aluminium groove contains the following accessories (excluding glass)



LCH-C02



12 mm to 13.14 mm tempered glass

1 m aluminium groove contains the following accessories (excluding glass)

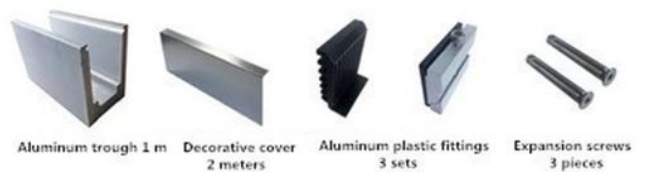

LCH-D01 / A02: ohne / mit Verkleidung zur Verwendung mit 12 mm bis 13,14 mm Glas

LCH-D01



12 mm to 13.14 mm tempered glass

1 m aluminium groove contains the following accessories (excluding glass)



Aluminum trough 1 m



Waterproof tape 2 meters



Aluminum plastic fittings 3 sets



Expansion screws 3 pieces

LCH-D02



12 mm to 13.14 mm tempered glass

1 m aluminium groove contains the following accessories (excluding glass)



Aluminum trough 1 m



Decorative cover 2 meters



Aluminum plastic fittings 3 sets



Expansion screws 3 pieces

**Für gewerbliche und private Anwendungen, foder sowohl Groß- als auch Einzelhandel (Wir sind Hersteller)
Nachfolgend einige Projektfotos:**







WEITERE ARTEN VON ALUMINIUM-U-KANAL FÜR GLASBAHN:

Small profile: for glass thickness 10-12.76mm

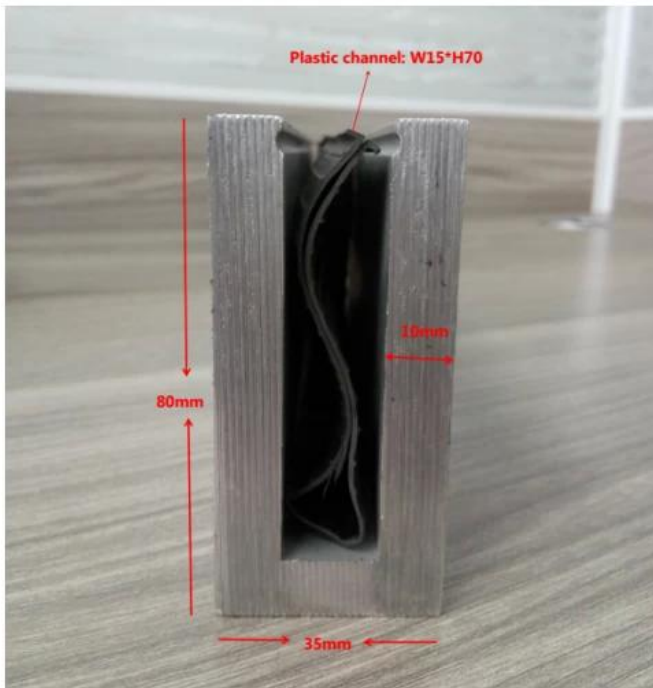

Big profile: for glass thickness 20-30mm

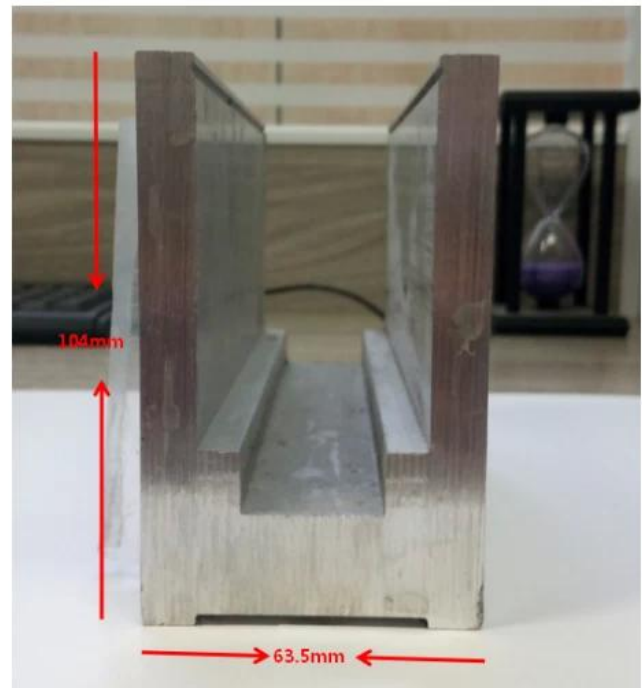

Verwandte Produkte:
- Schlitzrohrhandlauf.

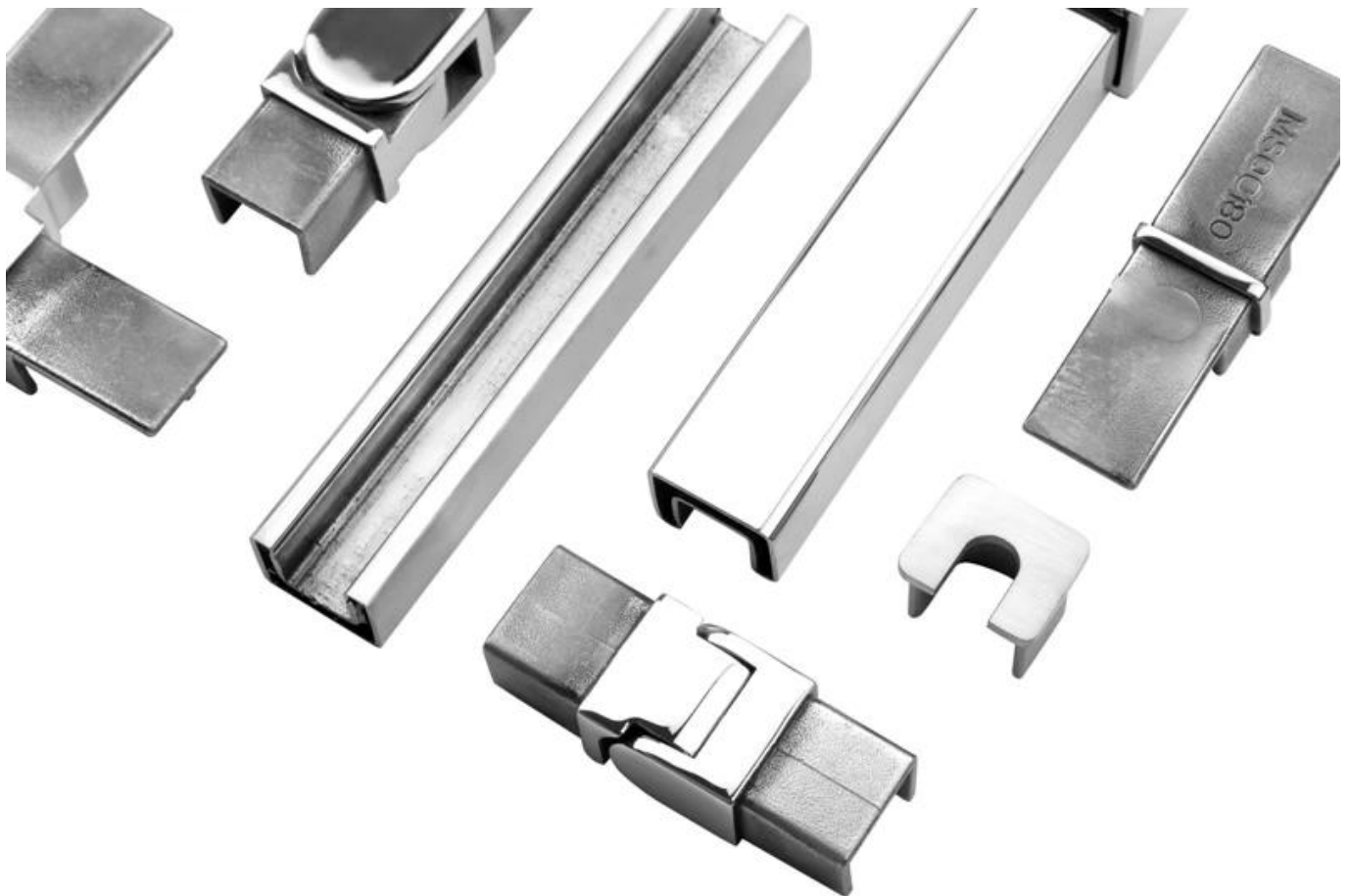



Kontaktieren Sie uns jetzt für weitere Informationen:

Wendy:: sales04@launch-china.cn

Mobil / WhatsApp: +86 159 8933 9827