

# SGS-Zertifizierung Alibaba bestätigte Gold plus Lieferant und 12 Jahre Mitgliedschaft

## COMPANY INTRODUCTION

Verification Type: Supplier Assessment Onsite Check

**Country / Region:**  
Guangdong, China ✓

**Year Established:**  
2004 ✓

**Main Products:**  
CNC Machining Parts, Stamping Pa... ✓

**Main Markets:**  
North America, Oceania, Mid East... ✓

**Total Annual Revenue:**  
confidential ✓

**Total Employees:**  
11 - 50 People ✓

### Alibaba.com Gold Plus Supplier

#### Main Product Lines Verification Report

*Presented to*

**Shenzhen Launch Co., Ltd.**

深圳市朗驰商贸有限公司

Company Address	B5003, Building 3, Yilida Building, No. 1092 Nanshan Avenue, Dengliang Community, Nanshan Street, Nanshan District, Shenzhen City, Guangdong Province, China
Consigner of Assessment:	Alibaba
Gold Supplier Member ID:	launch168
Gold Supplier Company Name:	Shenzhen Launch Co., Ltd.
Contact Person:	Mr. Binfeng Gao
Phone Number:	0086-13802569770
Fax Number:	0086-755-86372611
Email:	gbf999@china.com
Website Address (URL):	http://launch-china.en.alibaba.com

Service Provided by SGS  
Report No.: 19536352\_P+T



### Alibaba.com Gold Plus Supplier

**Verified**

#### Assessment Report

*Presented to*

**Cooperation Company of Shenzhen Launch Co., Ltd.**

深圳市朗驰商贸有限公司合作工厂

Gold Supplier & Assessed Company Relationship:	<input type="checkbox"/> Self-owned <input type="checkbox"/> Wholly Owned <input type="checkbox"/> Shareholder/Partner <input type="checkbox"/> Kindred between Owners <input checked="" type="checkbox"/> Cooperation Partner
Company Address	Confidential
City / Country:	Huizhou / China
Consigner of Assessment:	Alibaba & Shenzhen Launch Co., Ltd.
Gold Supplier Member ID:	launch168
Gold Supplier Company Name:	Shenzhen Launch Co., Ltd.
Contact Person:	Confidential
Phone Number:	Confidential
Fax Number:	Confidential
Email:	Confidential
Website Address (URL):	http://launch-china.en.alibaba.com

Service Provided by SGS  
Report No.: 19552720\_P



## WHY CHOOSE US



### 15 YEARS EXPERIENCE

We have been manufacturing railing hardware since 2004.



### ONE STOP SERVICE

We provide integrated railing solutions. We manufacture. We deliver.



### PROFESSIONAL R&D TEAM

We have engineering experts for developing new products.



### TOP QUALITY & GOOD PRICE

We are strict on quality control as well as cost evaluation.

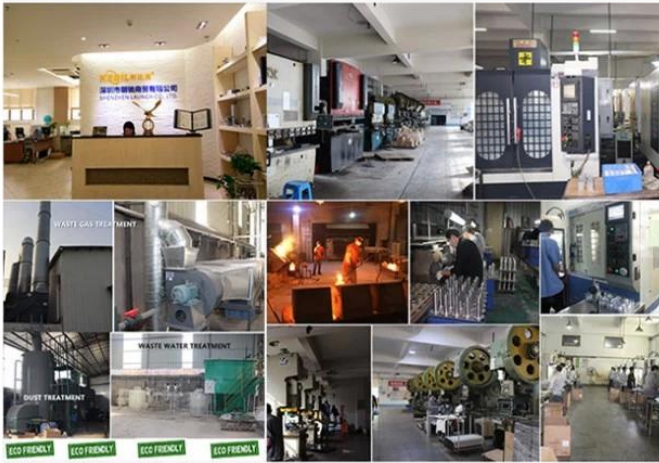

## ABOUT US

Shenzhen Launch Co., Ltd was established in 2004, located at Nanshan District, Shenzhen, and one hour by car from Hongkong International Airport. Our main products are high-grade building materials including stainless steel balustrade post, staircase handrail, balcony guardrail, swimming pool fence and other high-grade building materials. All the products are designed strictly according to the high-end market requirements. We have our own factory in Tangxia Town, Dongguan, with more than 50 sets of various precision equipments, such as CNC lathe, milling machine, punching machine, pipe cutter, argon welder, drilling machine, polisher, etc. which can provide customers with complete product processing services.

## Guangzhou-Baluster beschuht Aluminium-U-Kanal-Geländer-Profil

### Aluminium U Kanal Geländer Profil Spezifikationen

- Material: Aluminium 6063 T5
- Fertig: Eloxieren
- Länge: 4 mt pro länge oder benutzerdefinierte länge
- Für Glasdicke: 12-21,52 mm gehärtetes Glas
- Als Bausatz verkauft: inklusive Schrauben, Gummikanal und Armaturen

### Aluminium U-Kanal für 12mm Glas

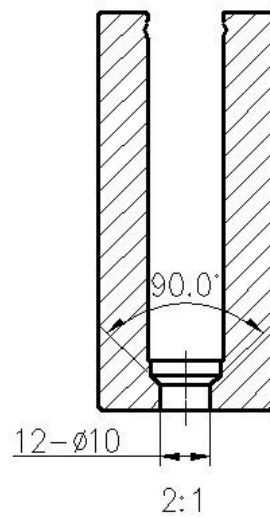
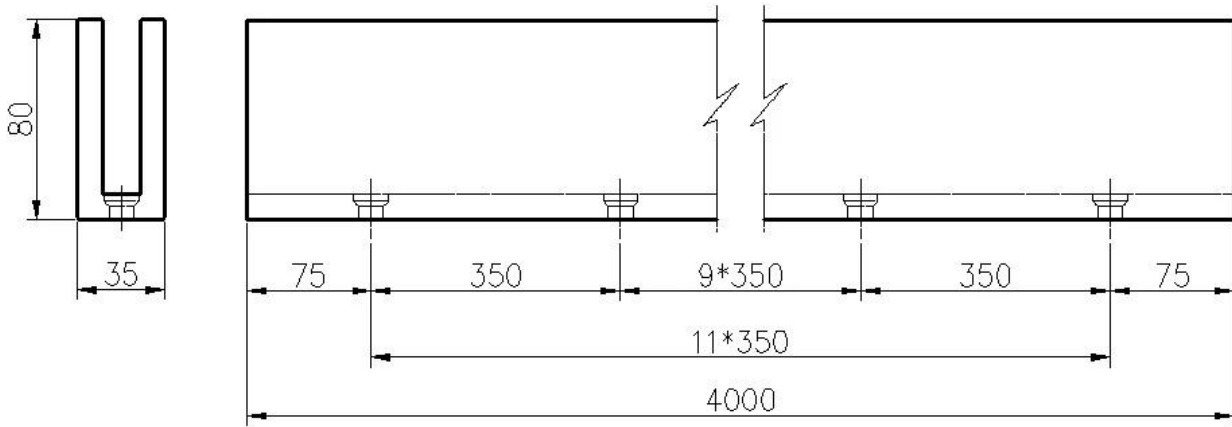
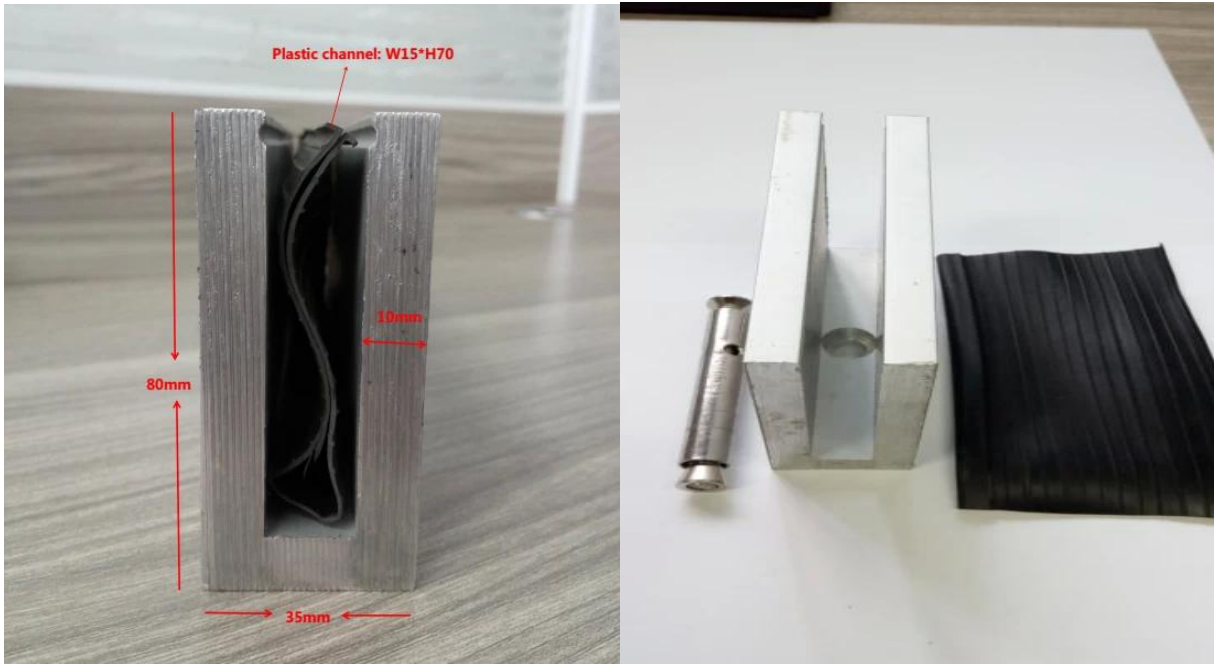

Aluminium U-Kanal Installation

# installation

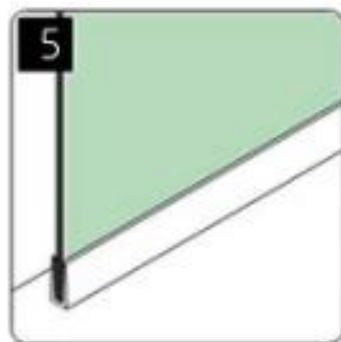
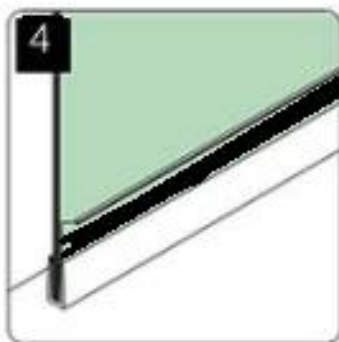
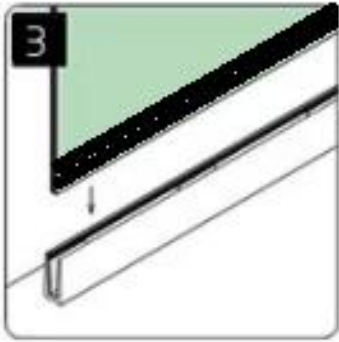
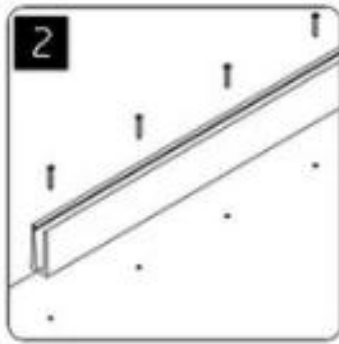
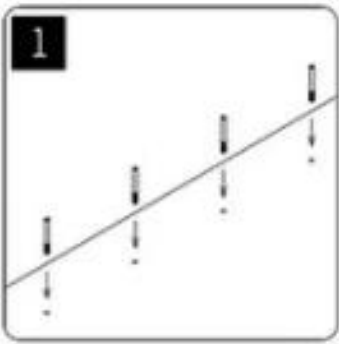

Andere modelle aluminium u kanal sie interessieren könnten

## LCH-C01



12 mm to 13.14 mm tempered glass

1 m aluminium groove contains the following accessories (excluding glass)



## LCH-C02



12 mm to 13.14 mm tempered glass

1 m aluminium groove contains the following accessories (excluding glass)

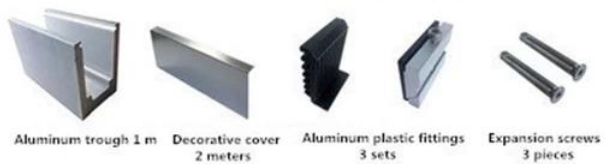

### LCH-D01



12 mm to 13.14 mm tempered glass

1 m aluminium groove contains the following accessories (excluding glass)



Aluminum trough 1 m    Waterproof tape 2 meters    Aluminum plastic fittings 3 sets    Expansion screws 3 pieces

### LCH-D02



12 mm to 13.14 mm tempered glass

1 m aluminium groove contains the following accessories (excluding glass)

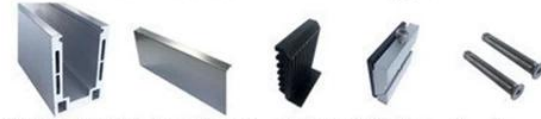

Aluminum trough 1 m    Decorative cover 2 meters    Aluminum plastic fittings 3 sets    Expansion screws 3 pieces

### LCH-B01



16 mm to 17.52 mm tempered glass

1 m aluminium groove contains the following accessories (excluding glass)



Aluminum trough 1 m    Waterproof tape 2 meters    Aluminum plastic fittings 3 sets    Expansion screws 3 pieces

### LCH-B02



16 mm to 17.52 mm tempered glass

1 m aluminium groove contains the following accessories (excluding glass)



Aluminum trough 1 m    Decorative cover 2 meters    Aluminum plastic fittings 3 sets    Expansion screws 3 pieces

LCH-A01



20 mm to 21.52 mm tempered glass

1 m aluminium groove contains the following accessories (excluding glass)



LCH-A02



20 mm to 21.52 mm tempered glass

1 m aluminium groove contains the following accessories (excluding glass)

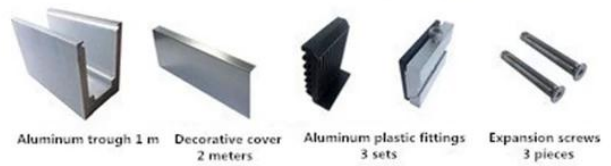

## Fotos des U-Kanal-Geländerprojekts von Alumnum







Aluminium U-Kanal-Packung





verbunden Produkte - C-Kanal-Glashandlaufkappe aus Edelstahl



## Kontakt

Danke für Ihren Besuch ! Jede frage oder anfrage, bitte hinterlassen sie eine nachricht. Wir werden uns innerhalb von 24 Stunden bei Ihnen melden.

Für dringende Anfragen kontaktieren Sie uns bitte unter:

-Kontakt: Doirs

-Email: [sales04@launch-china.cn](mailto:sales04@launch-china.cn)

-Büro: (86-755) 86037559

-Mob / Whats App: 0086-13530506265

-Skype: launch\_04