

Shenzhen Launch wurde 2004 gegründet und wir sind seit 16 Jahren SGS Goldlieferant. Wir sind zuverlässige Hersteller und Lieferanten.

## COMPANY INTRODUCTION

Verification Type: Supplier Assessment Onsite Check

<b>Country / Region:</b> Guangdong, China ✓	<b>Year Established:</b> 2004 ✓	<b>Main Products:</b> CNC Machining Parts, Stamping Pa... ✓
<b>Main Markets:</b> North America, Oceania, Mid East... ✓	<b>Total Annual Revenue:</b> confidential ✓	<b>Total Employees:</b> 11 - 50 People ✓

### Alibaba.com Gold Plus Supplier

#### Main Product Lines Verification Report

Presented to

**Shenzhen Launch Co., Ltd.**  
深圳市朗驰商贸有限公司

Company Address	B5003, Building 3, Yilida Building, No. 1092 Nanshan Avenue, Dengliang Community, Nanshan Street, Nanshan District, Shenzhen City, Guangdong Province, China
Consigner of Assessment:	Alibaba
Gold Supplier Member ID:	launch168
Gold Supplier Company Name:	Shenzhen Launch Co., Ltd.
Contact Person:	Mr. Binfeng Gao
Phone Number:	0086-13802569770
Fax Number:	0086-755-86372611
Email:	gbf990@china.com
Website Address (URL):	http://launch-china.en.alibaba.com

Service Provided by SGS  
Report No.: 19536352\_P+T



### Alibaba.com Gold Plus Supplier

**Verified**

#### Assessment Report

Presented to

**Cooperation Company of Shenzhen Launch Co., Ltd.**  
深圳市朗驰商贸有限公司合作工厂

Gold Supplier & Assessed Company Relationship:	<input type="checkbox"/> Self-owned <input type="checkbox"/> Wholly Owned <input type="checkbox"/> Shareholder/Partner <input type="checkbox"/> Kindred between Owners <input checked="" type="checkbox"/> Cooperation Partner
Company Address	Confidential
City / Country:	Huzhou / China
Consigner of Assessment:	Alibaba & Shenzhen Launch Co., Ltd.
Gold Supplier Member ID:	launch168
Gold Supplier Company Name:	Shenzhen Launch Co., Ltd.
Contact Person:	Confidential
Phone Number:	Confidential
Fax Number:	Confidential
Email:	Confidential
Website Address (URL):	http://launch-china.en.alibaba.com

Service Provided by SGS  
Report No.: 19552720\_P



## WHY CHOOSE US



### 15 YEARS EXPERIENCE

We have been manufacturing railing hardware since 2004.



### ONE STOP SERVICE

We provide integrated railing solutions. We manufacture. We deliver.



### PROFESSIONAL R&D TEAM

We have engineering experts for developing new products.



### TOP QUALITY & GOOD PRICE

We are strict on quality control as well as cost evaluation.



## ABOUT US

Shenzhen Launch Co., Ltd was established in 2004, located at Nanshan District, Shenzhen, and one hour by car from Hongkong International Airport. Our main products are high-grade building materials including stainless steel balustrade post, staircase handrail, balcony guardrail, swimming pool fence and other high-grade building materials. All the products are designed strictly according to the high-end market requirements. We have our own factory in Tangxia Town, Dongguan, with more than 50 sets of various precision equipments, such as CNC lathe, milling machine, punching machine, pipe cutter, argon welder, drilling machine, polisher, etc. which can provide customers with complete product processing services.

## Produktspezifikationen

Produktname	Abstandshalter aus Edelstahlglas
Material	304SS / 316SS
Oberflächenfinish	Satin / Spiegel / Andere
Körpergröße	Dia.50 * 30mm / 50 * 50mm
Kappengröße	Dia.50 * 12mm
Schraubengröße	M12 * 72 / M12 * 100 mm

## Produkt Show



**TechnischZeichnung**

**Glass standoff connect with wood**

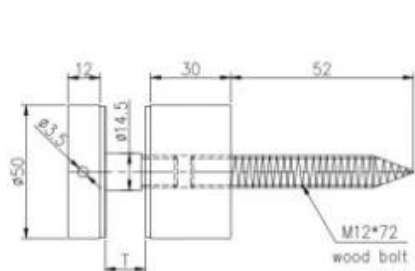

**Glass standoff connect with concrete**

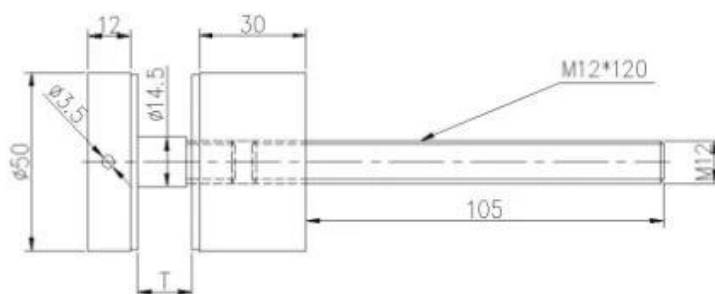

## Andere Standoff-Spezifikationen

### STAND OFF



Part No.	Material	Finish	Body	Bolt size
<ul style="list-style-type: none"> <li>▪ SF-30</li> <li>▪ SF-40</li> <li>▪ SF-50</li> <li>▪ SF-50A</li> </ul>	<ul style="list-style-type: none"> <li>▪ AISI 304</li> <li>▪ AISI 316</li> </ul>	<ul style="list-style-type: none"> <li>▪ Satin</li> <li>▪ Mirror</li> </ul>	<ul style="list-style-type: none"> <li>▪ 30x10; 30x25mm</li> <li>▪ 40x10; 40x30mm</li> <li>▪ 50x12; 50x30mm</li> <li>▪ 50x12; 50x50mm</li> <li>▪ silicon rubber gasket included</li> </ul>	<ul style="list-style-type: none"> <li>▪ M10x120 bolt</li> <li>▪ M10x72 wood screw</li> <li>▪ M8x100 bolt</li> <li>▪ M8 x72 wood screw</li> </ul>



Part No.	Material	Finish	Body	Bolt size
<ul style="list-style-type: none"> <li>▪ SF-38Z</li> </ul>	<ul style="list-style-type: none"> <li>▪ AISI 304</li> <li>▪ AISI 316</li> </ul>	<ul style="list-style-type: none"> <li>▪ Satin</li> <li>▪ Mirror</li> </ul>	<ul style="list-style-type: none"> <li>▪ hollow type</li> <li>▪ 38x7,5;38x38mm</li> <li>▪ silicon rubber gasket included</li> </ul>	<ul style="list-style-type: none"> <li>▪ M8x70 hexagonal screw</li> </ul>



Part No.	Material	Finish	Body	Mounting plate size
<ul style="list-style-type: none"> <li>▪ SF-50T</li> </ul>	<ul style="list-style-type: none"> <li>▪ AISI 304</li> <li>▪ AISI 316</li> </ul>	<ul style="list-style-type: none"> <li>▪ Satin</li> <li>▪ Mirror</li> </ul>	<ul style="list-style-type: none"> <li>▪ 50x10;50x30mm</li> <li>▪ silicon rubber gasket included</li> </ul>	<ul style="list-style-type: none"> <li>▪ 200x100x10mm</li> </ul>



**SF-50T**



**SF-50A**



**SF-50**



**SF-38**



**SF-38Z**



**SF-30**

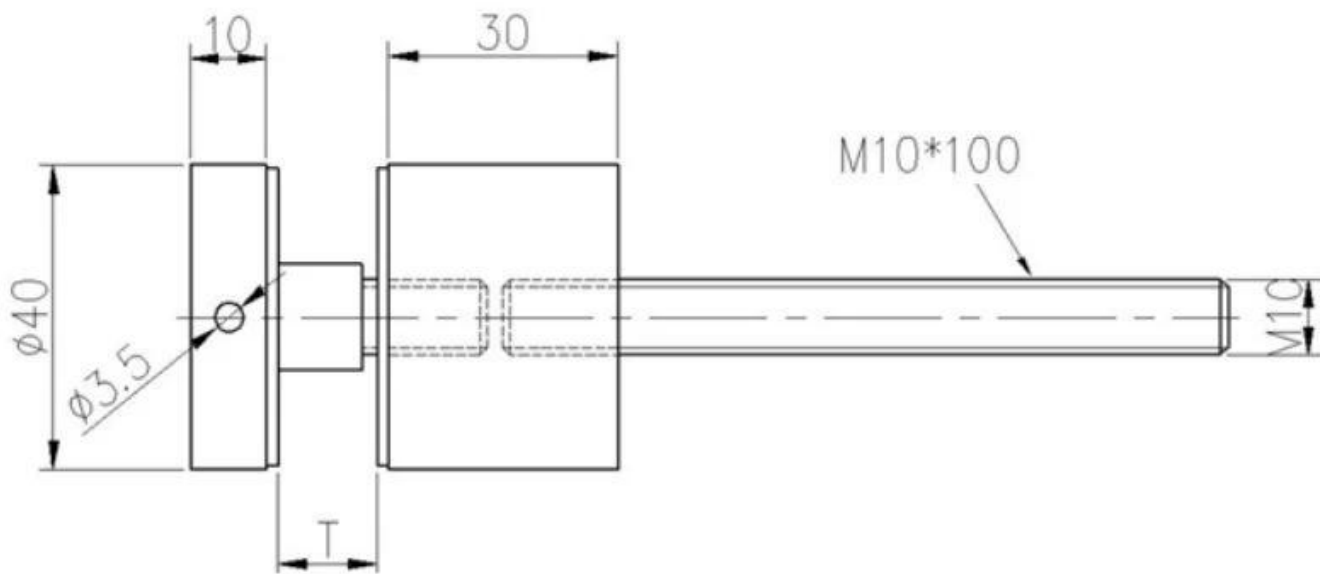
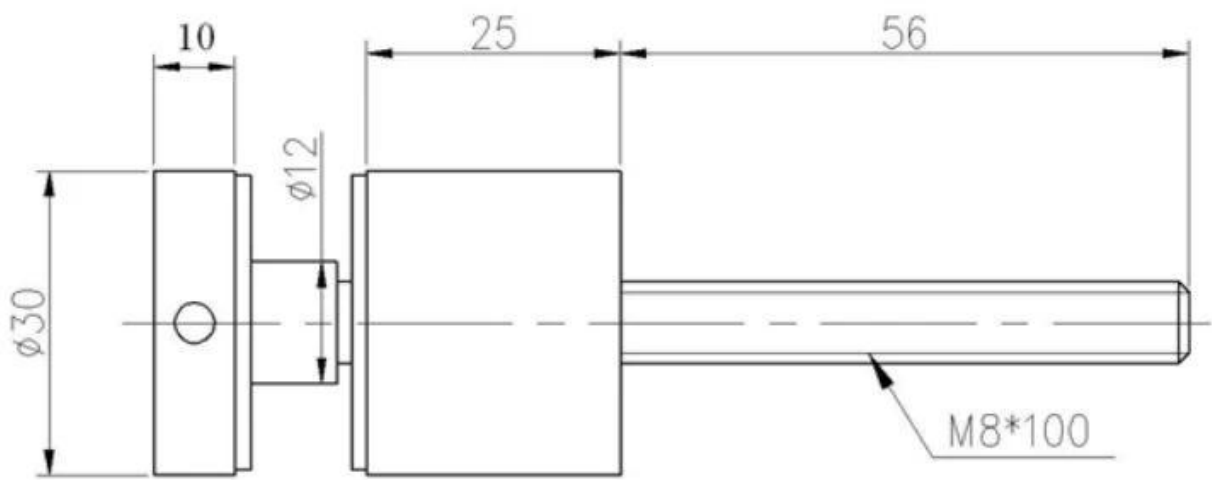
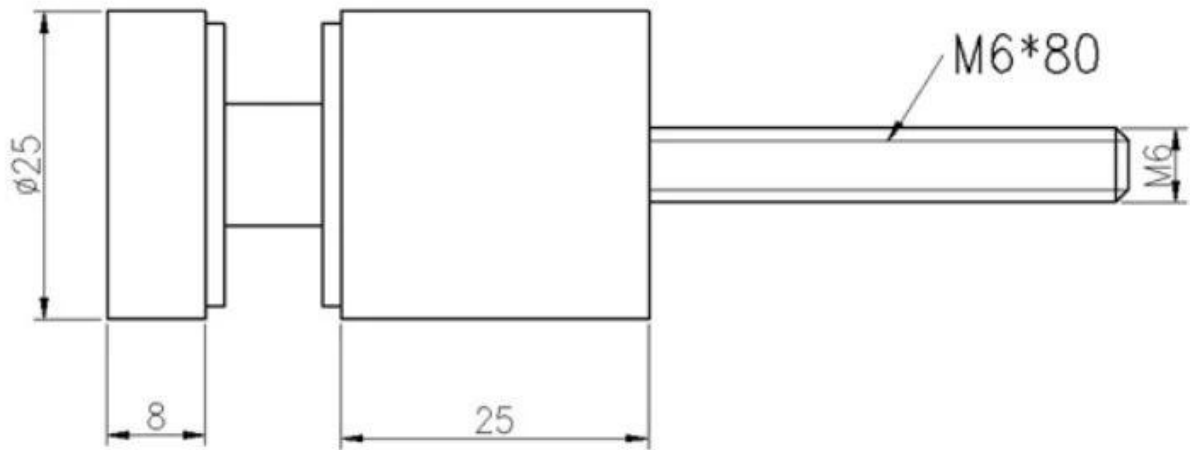

**MasseProduktion**



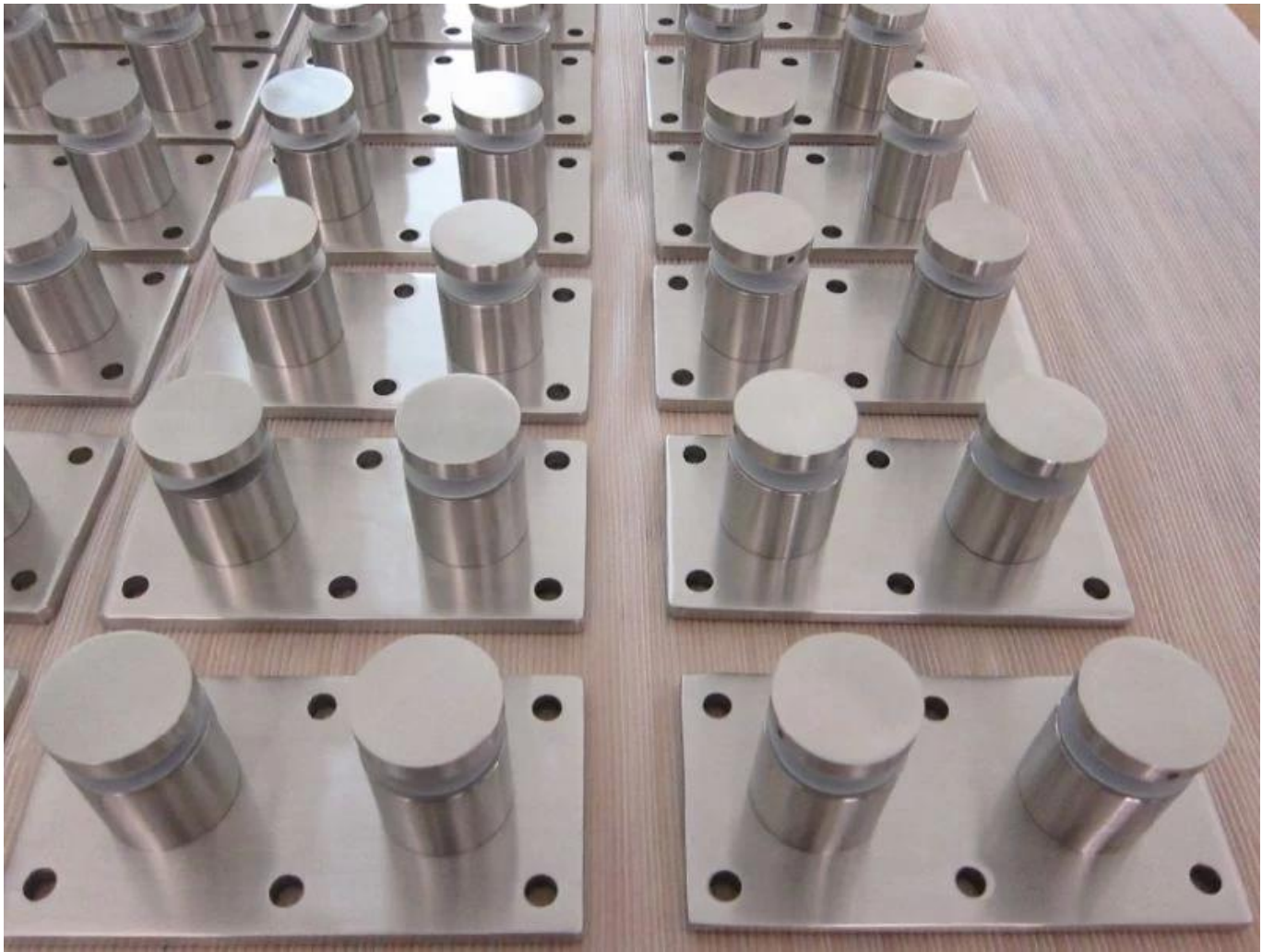

**Bilder verpacken**





**Abstandsglas-Blaustrade**

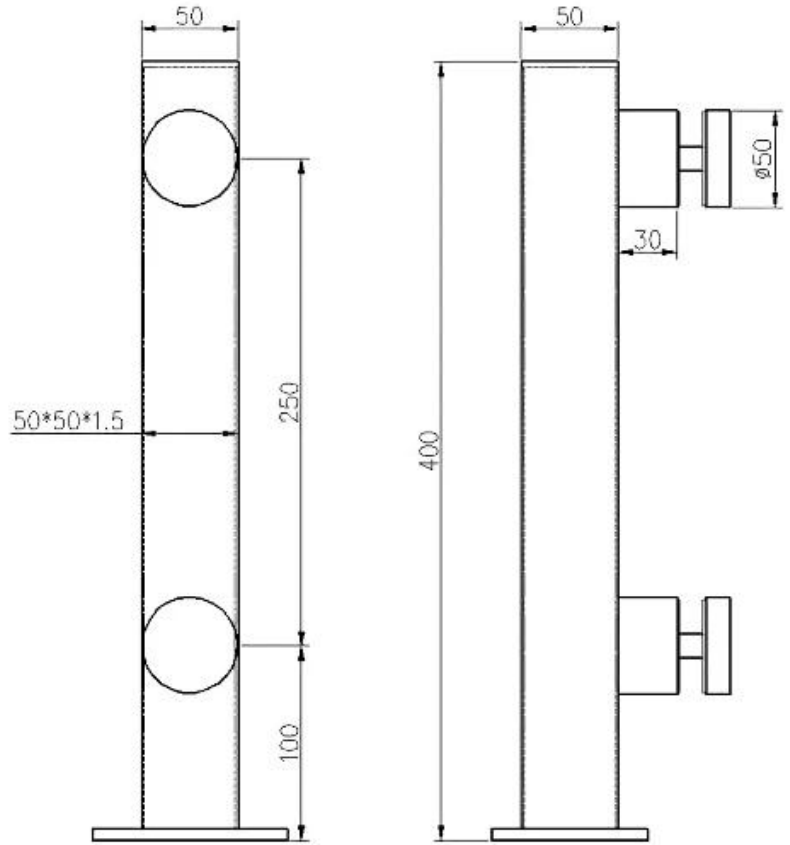

## Anwendungsbilder







**Bei Bedarf können Sie sich gerne an uns wenden.**

**Frank Fang**

**E-Mail: [sales02@launch-china.cn](mailto:sales02@launch-china.cn)**

**Telefon / WhatsApp / Wechat: +8615906261741**