

Montaje de araña de vidrio de acero inoxidable Montaje de dosel de vidrio Montaje de araña de barandilla de vidrio





1. Especificaciones del balaustre del poste de la araña del acero inoxidable

Especificaciones :

Producto Nombre	Balaustre de poste de araña cuadrado de acero inoxidable
N ° de Modelo.	LCH-121
Material	Acero inoxidable 304/316.
Terminar	Cepillado o pulido espejo
Tamaño de poste cuadrado	50 x 50 x 1.5 mm espesor de pared 40 x 40 x 1.5 mm espesor de pared
Altura	Personalizable
Para espesor de vidrio	10-15mm
Solicitud	Diseño de la barandilla del balcón Diseño de barandilla porche Diseño de barandilla cubierta Diseño de barandilla de escalera



2. Dibujo de dimensión de poste de araña cuadrado de acero inoxidable para su referencia:

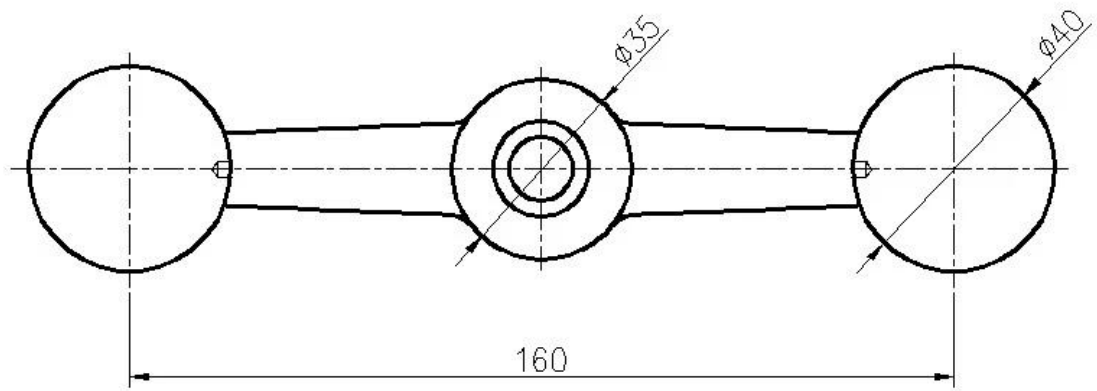
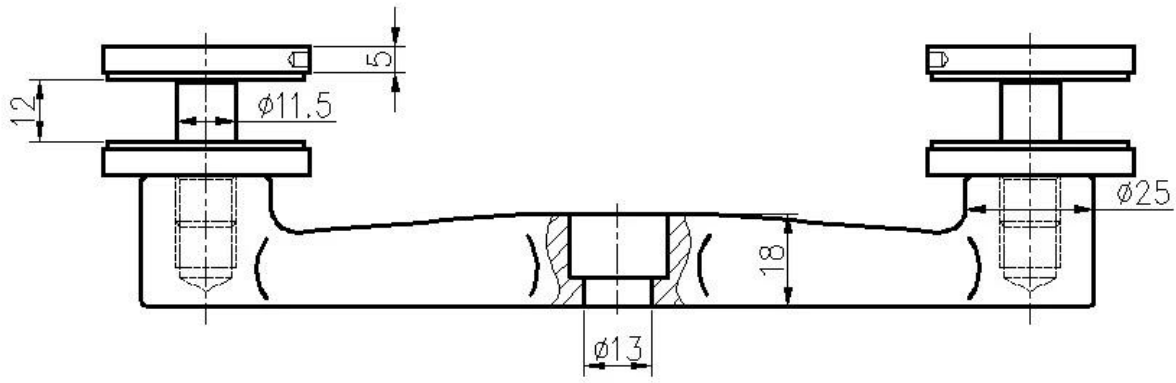

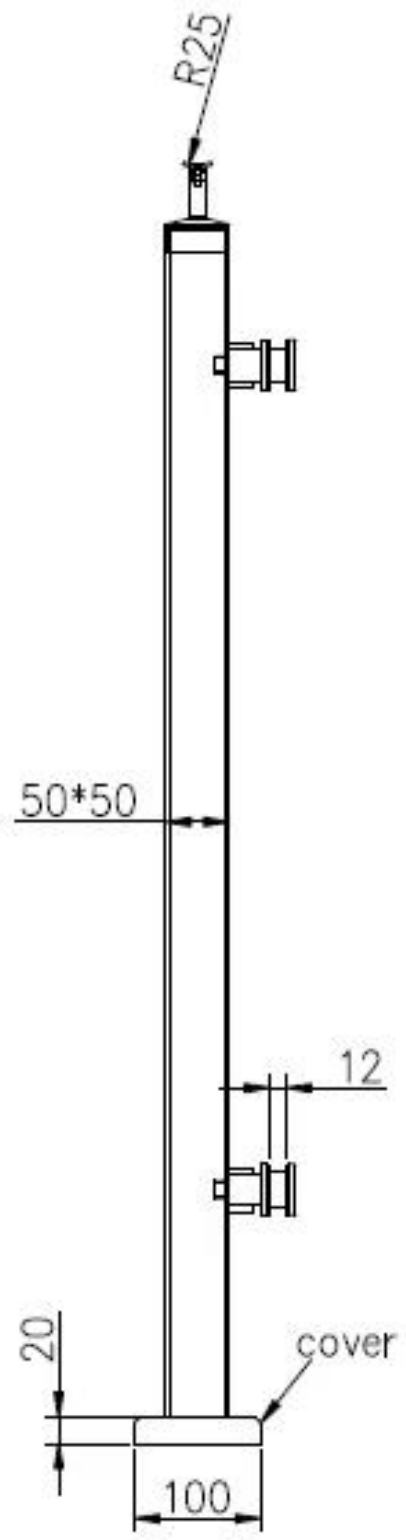
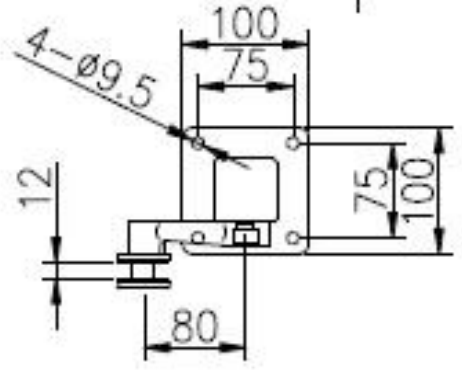
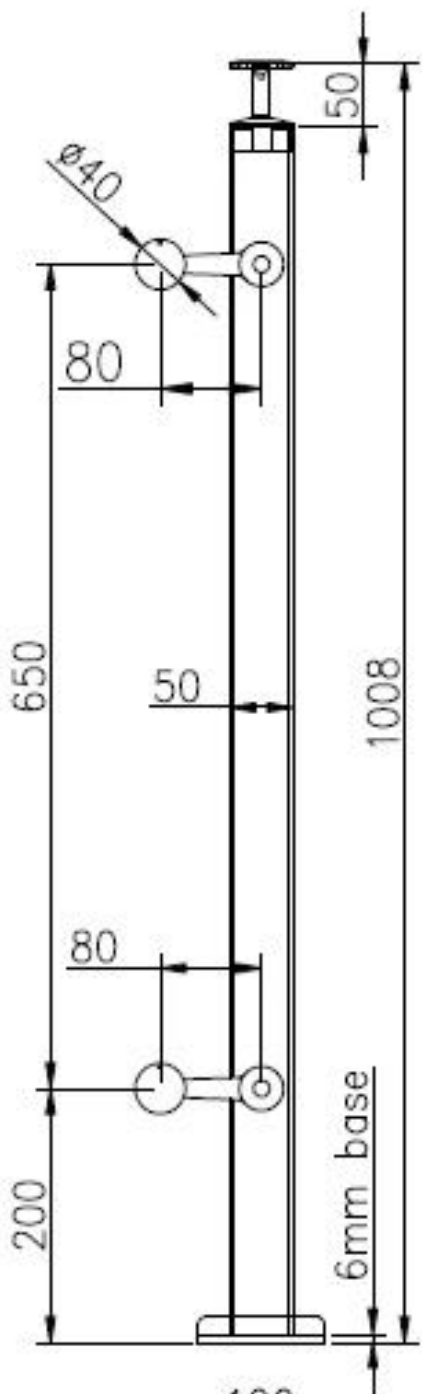

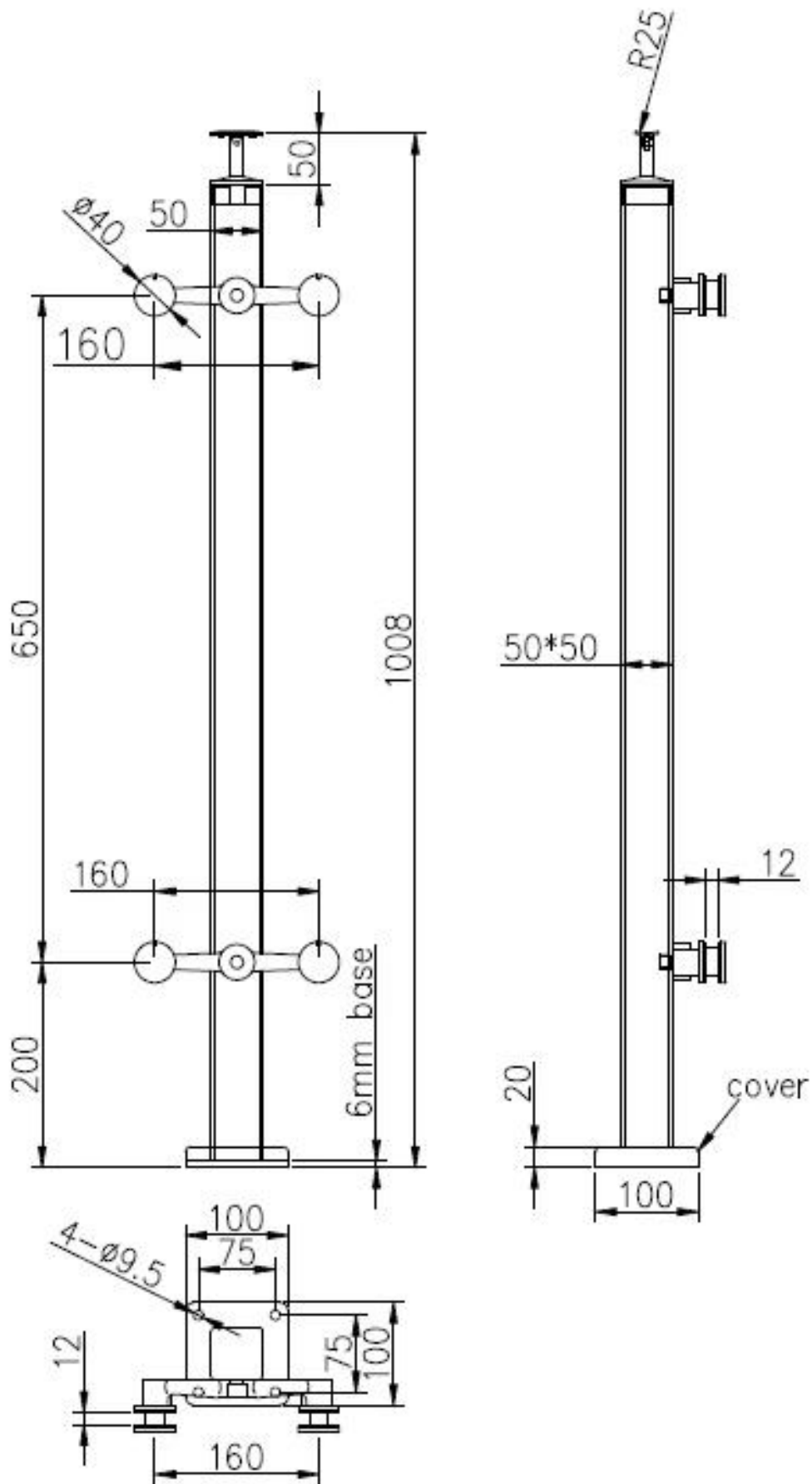

3. Fotos de poste de balaustre de araña de acero inoxidable:
Soporte de pasamanos ajustable superior para pasamanos de tubo

cuadrado o redondo:



Post intermedio de 2 vías:



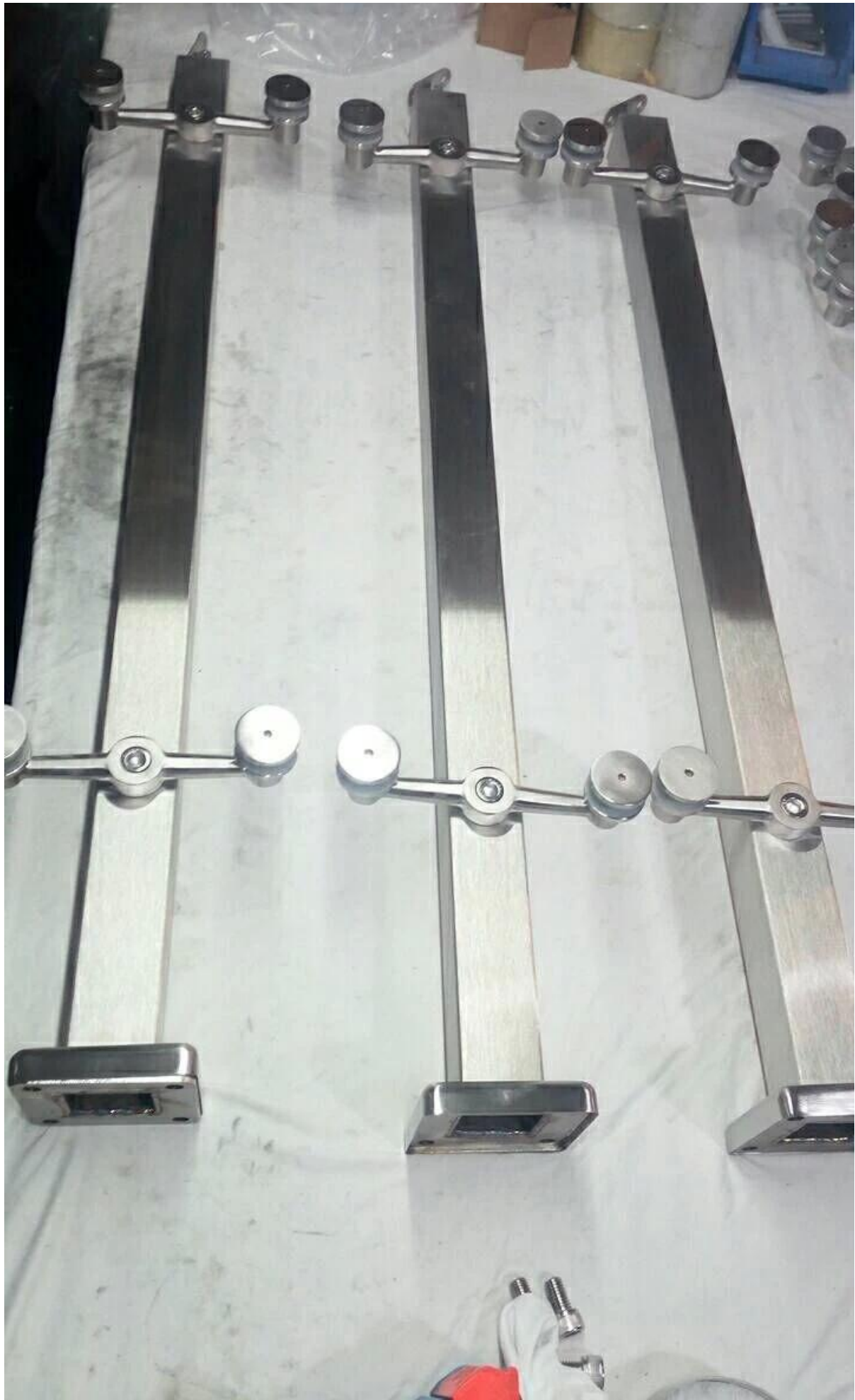

1 camino final puesto:



4. Fotos de embalaje: 1 unid / bolsa de plástico, 2 - 4 unids / ctn.





Otros tipos de accesorios de araña:

- Araña de acero inoxidable para muro cortina.



- Racor Spider OEM para sistemas de balaustrada de vidrio

KEBIL 科比奥®



Empresa Información:

Shenzhen Launch Co., Ltd was established in 2004, located at Nanshan District, Shenzhen, and one hour by car from Hongkong International Airport. Our main product is high-grade building materials includes stainless steel balustrade post, staircase handrail, balcony guardrail, swimming pool fence and other high-grade building materials. All the products are designed strictly according to the high-end market requirements. We have our own factory in Tangxia Town, Dongguan, has a variety of precision equipment more than 50 sets: CNC lathe, milling machine, punching machine, pipe cutter, argon welder, drilling machine, polisher, etc. which can provide customers with complete product processing services. With the German SPECTRO Spectrometer, we insist on testing every batch of materials to ensure that the material is highly qualified. We also have hardness gauge, secondary element and other test equipment to ensure the products meets customers' requirements.

ABOUT US



OUR ADVANTAGE

Please do not hesitate to contact us if you have any requirement regarding our production lines, you can expect a timely reply with professional solutions!



Own factory, shortest lead time.



Can help customers design product drawings based on customer ideas and design engineering installation drawing according to the customer site sketch.



Sample order, trial order acceptable.



Provide material test report to ensure that the material is qualified.



13 years of industry experience, we can help customers recommend the best solution to help customers save cost.

OUR FACTORY

More than 13 years experience in hardware industry design and processing, we can provide customized services from design to the sample and small batch trial production.



OUR CERTIFICATE

With premium quality, competitive price and superior service, we won a lot of customers' favor.
Our products are popular in North America, European and Australia.



PRODUCTION PROCESS



Casting



CNC lathe



CNC Milling



Stamping



Drilling & Tapping



Polishing



PACKAGING & DELIVERY



PAYMENT & TRANSPORTATION

Welcome Alibaba Trade Assurance Order!

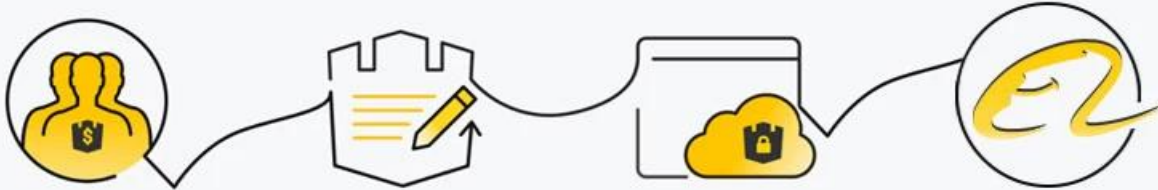

1 Start an order

2 Negotiate terms with our sales service & confirm order

3 Make payment

4 Alibaba provide full assurance



Por favor, póngase en contacto con nosotros libremente para más información:
Correo electrónico: sales03@launch-china.cn
Contacto: Eve Chow
WhatsApp / HP: +8615907334556