

# Certificación SGS Alibaba verificado proveedor de oro plus y 12 años de membresía

## COMPANY INTRODUCTION

Verification Type: Supplier Assessment Onsite Check

**Country / Region:**  
Guangdong, China ✓

**Year Established:**  
2004 ✓

**Main Products:**  
CNC Machining Parts, Stamping Pa... ✓

**Main Markets:**  
North America, Oceania, Mid East... ✓

**Total Annual Revenue:**  
confidential ✓

**Total Employees:**  
11 - 50 People ✓

Alibaba.com Gold Plus Supplier

Alibaba.com Gold Plus Supplier

### Main Product Lines Verification Report

**Verified**

### Assessment Report

*Presented to*

*Presented to*

**Shenzhen Launch Co., Ltd.**

**Cooperation Company of Shenzhen Launch Co., Ltd.**

深圳市朗驰商贸有限公司

深圳市朗驰商贸有限公司合作工厂

Company Address	B5003, Building 3, Yilida Building, No. 1092 Nanshan Avenue, Dengliang Community, Nanshan Street, Nanshan District, Shenzhen City, Guangdong Province, China
Consigner of Assessment:	Alibaba
Gold Supplier Member ID:	launch168
Gold Supplier Company Name:	Shenzhen Launch Co., Ltd.
Contact Person:	Mr. Binfeng Gao
Phone Number:	0086-13802569770
Fax Number:	0086-755-86372611
Email:	gbf999@china.com
Website Address (URL):	http://launch-china.en.alibaba.com

Gold Supplier & Assessed Company Relationship:	<input type="checkbox"/> Self-owned <input type="checkbox"/> Wholly Owned <input type="checkbox"/> Shareholder/Partner <input type="checkbox"/> Kindred between Owners <input checked="" type="checkbox"/> Cooperation Partner
Company Address	Confidential
City / Country:	Huizhou / China
Consigner of Assessment:	Alibaba & Shenzhen Launch Co., Ltd.
Gold Supplier Member ID:	launch168
Gold Supplier Company Name:	Shenzhen Launch Co., Ltd.
Contact Person:	Confidential
Phone Number:	Confidential
Fax Number:	Confidential
Email:	Confidential
Website Address (URL):	http://launch-china.en.alibaba.com

Service Provided by SGS  
Report No.: 19536352\_P+T

Service Provided by SGS  
Report No.: 19552720\_P



## WHY CHOOSE US



### 15 YEARS EXPERIENCE

We have been manufacturing railing hardware since 2004.



### ONE STOP SERVICE

We provide integrated railing solutions. We manufacture. We deliver.



### PROFESSIONAL R&D TEAM

We have engineering experts for developing new products.



### TOP QUALITY & GOOD PRICE

We are strict on quality control as well as cost evaluation.

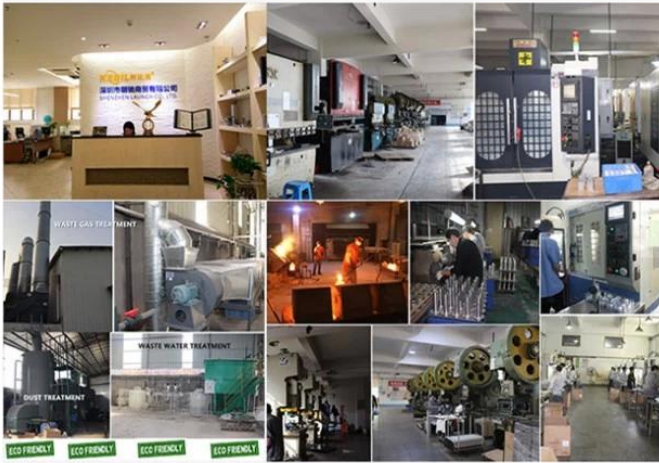

## ABOUT US

Shenzhen Launch Co., Ltd was established in 2004, located at Nanshan District, Shenzhen, and one hour by car from Hongkong International Airport. Our main products are high-grade building materials including stainless steel balustrade post, staircase handrail, balcony guardrail, swimming pool fence and other high-grade building materials. All the products are designed strictly according to the high-end market requirements. We have our own factory in Tangxia Town, Dongguan, with more than 50 sets of various precision equipments, such as CNC lathe, milling machine, punching machine, pipe cutter, argon welder, drilling machine, polisher, etc. which can provide customers with complete product processing services.

## Perfil de barandilla de aluminio del canal U de los zapatos de balaustre de Guangzhou

### Aluminio U canal barandilla perfil especificaciones

- Material: aluminio 6063 T5
- Acabado: anodizado
- Longitud: 4 m por longitud o longitud personalizada
- Para grosor de vidrio: vidrio templado de 12-21.52 mm
- Se vende como un kit: incluye tornillos, canal de goma y accesorios

### Canal U de aluminio para vidrio de 12 mm

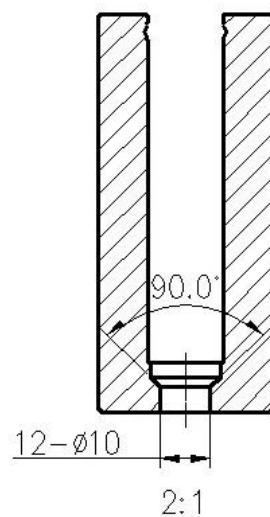
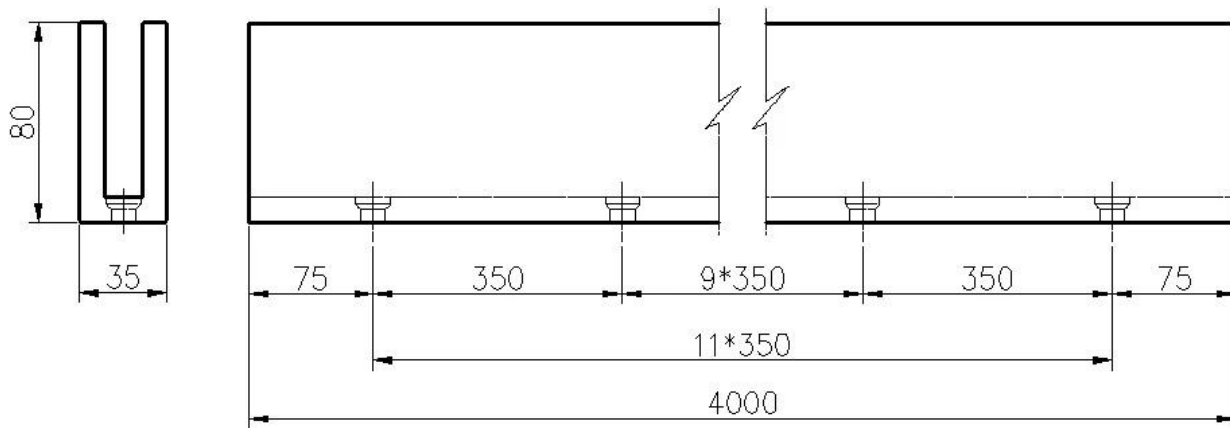
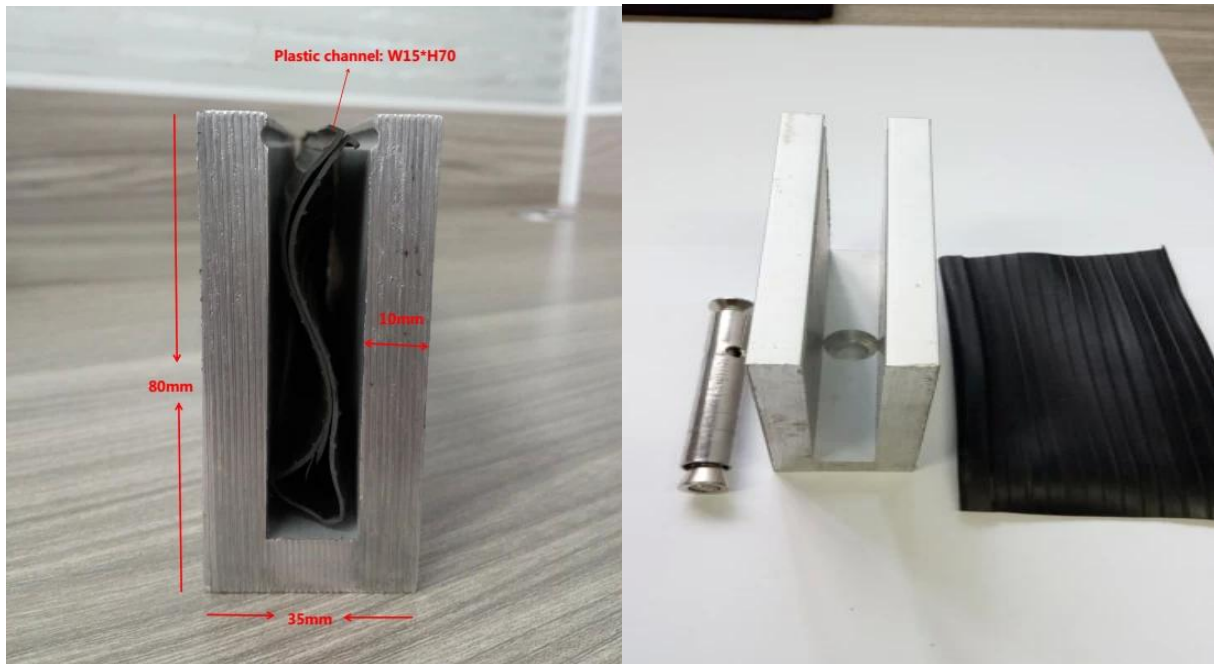

Instalación de canal U de aluminio

# installation

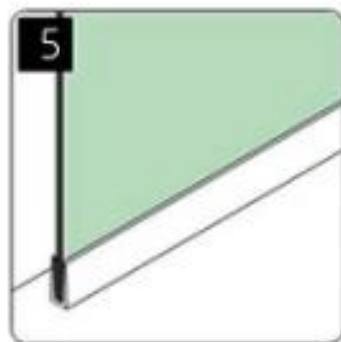
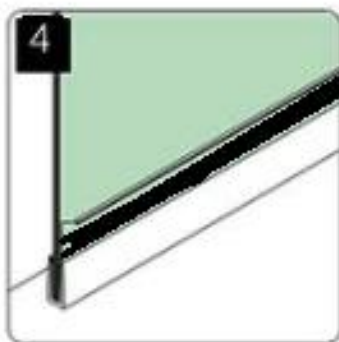
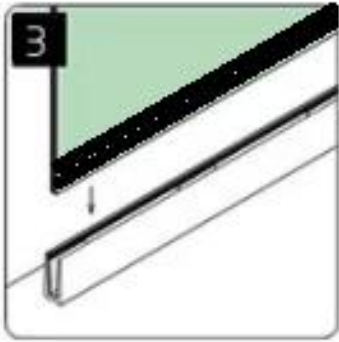
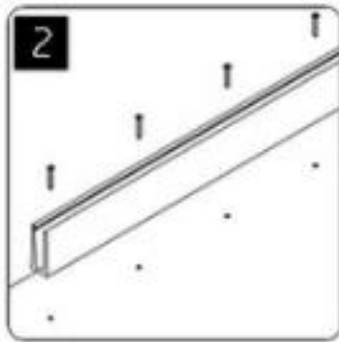
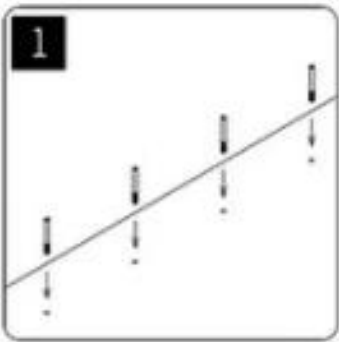

## Otros modelos de canal U de aluminio que te pueden interesar

**LCH-C01**



12 mm to 13.14 mm tempered glass

1 m aluminium groove contains the following accessories (excluding glass)

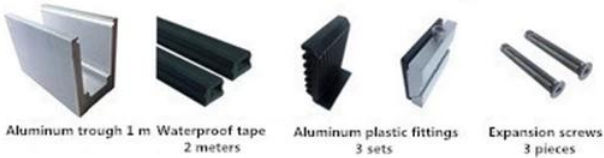

**LCH-C02**



12 mm to 13.14 mm tempered glass

1 m aluminium groove contains the following accessories (excluding glass)



### LCH-D01



12 mm to 13.14 mm tempered glass

1 m aluminium groove contains the following accessories (excluding glass)



Aluminum trough 1 m    Waterproof tape 2 meters    Aluminum plastic fittings 3 sets    Expansion screws 3 pieces

### LCH-D02



12 mm to 13.14 mm tempered glass

1 m aluminium groove contains the following accessories (excluding glass)

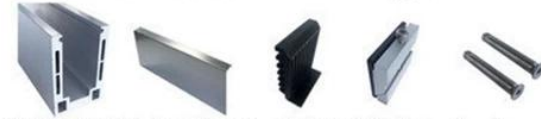

Aluminum trough 1 m    Decorative cover 2 meters    Aluminum plastic fittings 3 sets    Expansion screws 3 pieces

### LCH-B01



16 mm to 17.52 mm tempered glass

1 m aluminium groove contains the following accessories (excluding glass)



Aluminum trough 1 m    Waterproof tape 2 meters    Aluminum plastic fittings 3 sets    Expansion screws 3 pieces

### LCH-B02



16 mm to 17.52 mm tempered glass

1 m aluminium groove contains the following accessories (excluding glass)



Aluminum trough 1 m    Decorative cover 2 meters    Aluminum plastic fittings 3 sets    Expansion screws 3 pieces



LCH-A01



20 mm to 21.52 mm tempered glass

1 m aluminium groove contains the following accessories (excluding glass)



Aluminum trough 1 m Waterproof tape 2 meters

Aluminum plastic fittings 3 sets

Expansion screws 3 pieces

LCH-A02



20 mm to 21.52 mm tempered glass

1 m aluminium groove contains the following accessories (excluding glass)

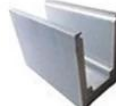

Aluminum trough 1 m

Decorative cover 2 meters

Aluminum plastic fittings 3 sets

Expansion screws 3 pieces

Fotos del proyecto de barandas del canal U de Aluminum









Paquete de canal U de aluminio





Relacionado productos - tapa de barandilla de vidrio de canal C de acero inoxidable



## Contacto

Gracias por su visita ! Cualquier pregunta o consulta, por favor deje un mensaje. Nos comunicaremos con usted dentro de las 24 horas.

Cualquier consulta urgente, contáctenos a continuación:

-Contacto: Doirs

-Email: [sales04@launch-china.cn](mailto:sales04@launch-china.cn)

-Oficina: (86-755) 86037559

-Mob / cuál es la aplicación: 0086-13530506265

-Skype: lanzamiento\_04