

**Shenzhen Launch a été créé en 2004 et nous sommes fournisseur d'or de SGS depuis 16 ans. Nous sommes des fabricants et des fournisseurs fiables.**

COMPANY INTRODUCTION

Verification Type: Supplier Assessment Onsite Check

<b>Country / Region:</b> Guangdong, China ✓	<b>Year Established:</b> 2004 ✓	<b>Main Products:</b> CNC Machining Parts, Stamping Pa... ✓
<b>Main Markets:</b> North America, Oceania, Mid East... ✓	<b>Total Annual Revenue:</b> confidential ✓	<b>Total Employees:</b> 11 - 50 People ✓

Alibaba.com Gold Plus Supplier

Alibaba.com Gold Plus Supplier

Main Product Lines Verification Report

**Verified**

Assessment Report

Presented to

Presented to

**Shenzhen Launch Co., Ltd.**

**Cooperation Company of Shenzhen Launch Co., Ltd.**

深圳市朗驰商贸有限公司

深圳市朗驰商贸有限公司合作工厂

Company Address	B5003, Building 3, Yilida Building, No. 1092 Nanshan Avenue, Dengliang Community, Nanshan Street, Nanshan District, Shenzhen City, Guangdong Province, China
Consigner of Assessment:	Alibaba
Gold Supplier Member ID:	launch168
Gold Supplier Company Name:	Shenzhen Launch Co., Ltd.
Contact Person:	Mr. Binfeng Gao
Phone Number:	0086-13802569770
Fax Number:	0086-755-86372611
Email:	gbf990@china.com
Website Address (URL):	http://launch-china.en.alibaba.com

Gold Supplier & Assessed Company Relationship:	<input type="checkbox"/> Self-owned <input type="checkbox"/> Wholly Owned <input type="checkbox"/> Shareholder/Partner <input type="checkbox"/> Kindred between Owners <input checked="" type="checkbox"/> Cooperation Partner
Company Address	Confidential
City / Country:	Huzhou / China
Consigner of Assessment:	Alibaba & Shenzhen Launch Co., Ltd.
Gold Supplier Member ID:	launch168
Gold Supplier Company Name:	Shenzhen Launch Co., Ltd.
Contact Person:	Confidential
Phone Number:	Confidential
Fax Number:	Confidential
Email:	Confidential
Website Address (URL):	http://launch-china.en.alibaba.com

Service Provided by SGS  
Report No.: 19536352\_P+T

Service Provided by SGS  
Report No.: 19552720\_P



## WHY CHOOSE US



### 15 YEARS EXPERIENCE

We have been manufacturing railing hardware since 2004.



### ONE STOP SERVICE

We provide integrated railing solutions. We manufacture. We deliver.



### PROFESSIONAL R&D TEAM

We have engineering experts for developing new products.



### TOP QUALITY & GOOD PRICE

We are strict on quality control as well as cost evaluation.

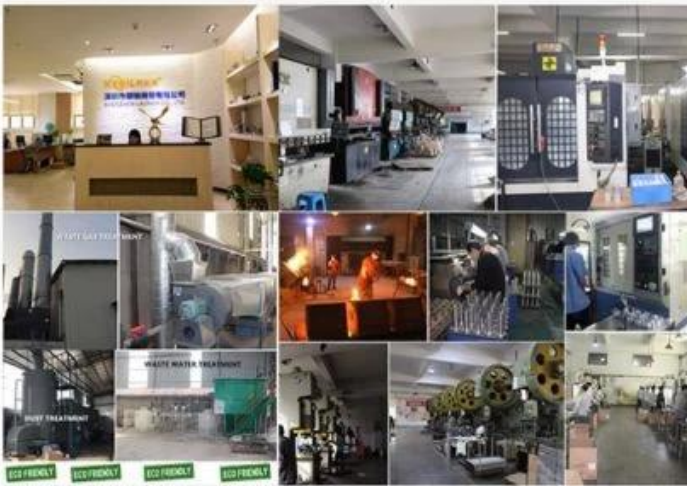

## ABOUT US

Shenzhen Launch Co., Ltd was established in 2004, located at Nanshan District, Shenzhen, and one hour by car from Hongkong International Airport. Our main products are high-grade building materials including stainless steel balustrade post, staircase handrail, balcony guardrail, swimming pool fence and other high-grade building materials. All the products are designed strictly according to the high-end market requirements. We have our own factory in Tangxia Town, Dongguan, with more than 50 sets of various precision equipments, such as CNC lathe, milling machine, punching machine, pipe cutter, argon welder, drilling machine, polisher, etc. which can provide customers with complete product processing services.

## ProduitSpectacle

<b>Nom du produit</b>	Tube à fente carré ou rond
<b>Matériel</b>	SS304 / SS316
<b>Finition de surface</b>	Satin / Miroir / Autre
<b>Épaisseur du verre</b>	10 mm, 12 mm, etc.
<b>Produit le couper</b>	5,8 mètres / pcs ou couper selon les exigences des clients
<b>Application</b>	Système de garde-corps en verre pour l'intérieur et l'extérieur

### Tube carré à fente



**25×21MM, GROOVE 14×14MM**

Surface treatment: satin brushed / mirror polished

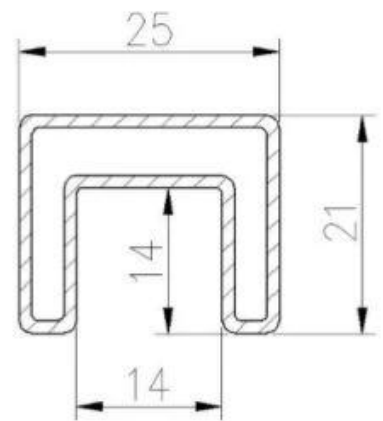

25\*21 tube

**Model: SQ2521**

**21\*25mm slot handrail**

**5.8 m per length**



180 degree joiner



90 degree joiner



Vertical adjustable joiner



Horizontal | adjustable joiner



Wall to handrail joiner



End cap



90 degree Corner connector

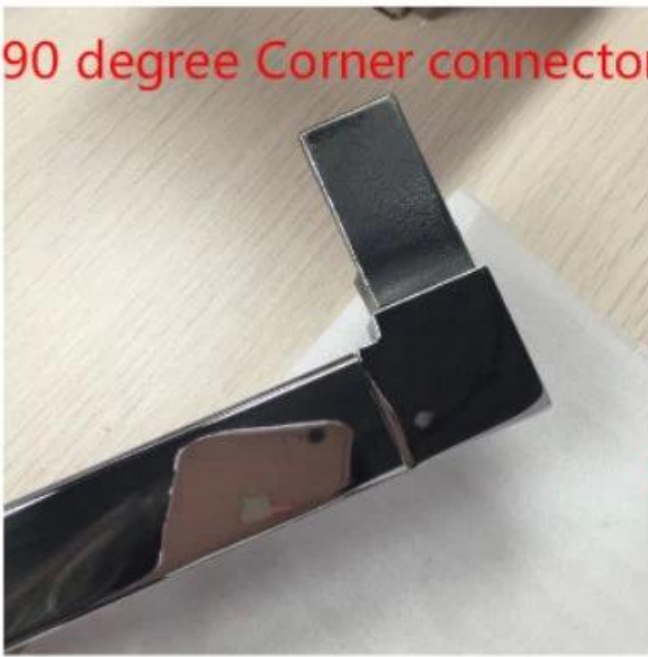

180 degree middle connector



End Cap



Wall Bracket



**Tube rond à fente**

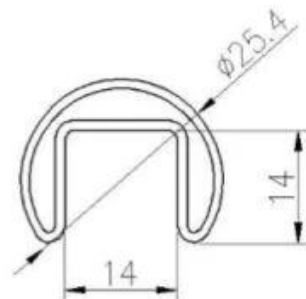

**DIAMETER 25.4MM, GROOVE 14×14MM**

Surface treatment: satin brushed / mirror polished

**Model: RD2525**

Round Slot Handrail Tube  
SS 316L  $\phi$  25.4mm  
5.8m per length



90 ° corner connector



180° connector



End cap









rail-wall connector

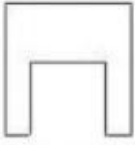

**Différentes structures et tailles**

## STAINLESS STEEL SLOT TUBE

	DIAMETER (MM)	SLOT WIDTH (MM)	SLOT DEPTH (MM)		DIAMETER (MM)	SLOT WIDTH (MM)	SLOT DEPTH (MM)
 ROUND SINGLE SLOT	38	15	15	 ROUND 90 DEGREE SLOT	50.8	15	15
	42.4	15	15				
	42.4	24	24				
	45	20	20				
	50.8	15	15				
	50.8	20	20	 SQUARE SINGLE SLOT	30x30	15	15
	50.8	25	25		38x38	15	15
	50.8	30	30		40x40	15	15
	50.8	15	20		40x40	20	20
	60.3	20	20		40x40	24	24
60.3	25	25	50x50		15	15	
63.5	15	15	50x50		20	20	
63.5	20	20	50x50		24	24	
63.5	25	25	 SQUARE DOUBLE SLOT		40x40	15	15
63.5	30	30			50x50	15	15
76	15	15					
76	20	20					
76	25	25					
76	30	30	 SQUARE 90 DEGREE SLOT	50x50	15	15	
 ROUND DOUBLE SLOT	50.8	15					15
	50.8	25*16					16*12
	63	20					20
	63	25	25				

**Balustradesystèmecommeau dessous de**



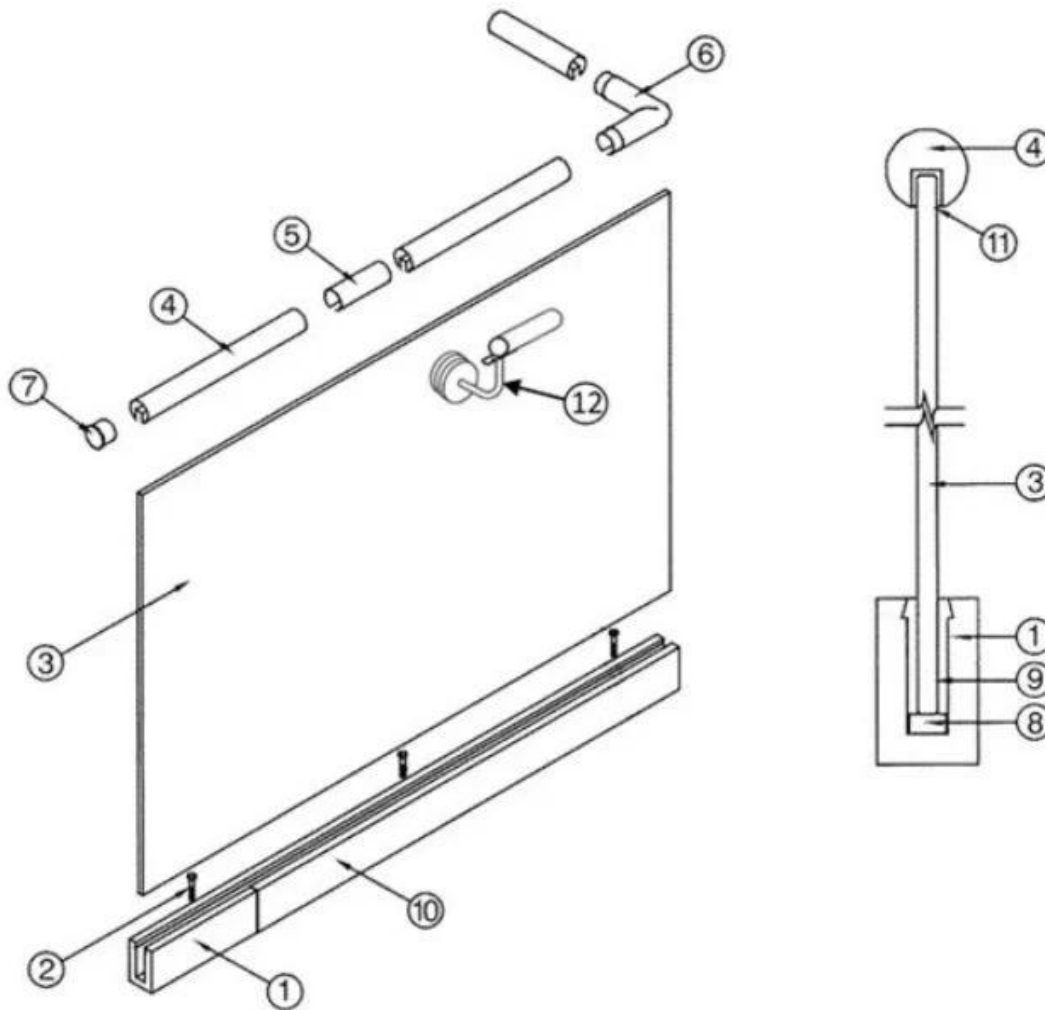

- |  |   |
|--|---|
| <ul style="list-style-type: none"> <li>1. Aluminum Railing Base</li> <li>2. Stainless Cap Screw</li> <li>3. ½" Tempered Float Glass</li> <li>4. Top Rail</li> <li>5. Splice</li> <li>6. Corner fitting<br/>(Horizontal Shown Vertical<br/>Also Available)</li> </ul> | <ul style="list-style-type: none"> <li>7. End Cap</li> <li>8. Setting Block</li> <li>9. Expansive Cement</li> <li>10. Cladding</li> <li>11. Protective Insert</li> <li>12. Handrail Brackets and Fittings<br/>Also Available</li> </ul> |
|--|---|

## Masseproduction





**Emballage photo**



Plastic inner packaging



Cardboard sleeve



Metal frame

## Projetspectacle







**Si vous avez des questions pour eux, n'hésitez pas à me contacter**

**Frank Fang**

**Courriel: [sales02@launch-china.cn](mailto:sales02@launch-china.cn)**

**Téléphone / WhatsApp / Wechat: +86159 0626 1741**