

Certification SGS Alibaba vérifié or, plus fournisseur et 12 ans d'adhésion

COMPANY INTRODUCTION

Verification Type:  Supplier Assessment  Onsite Check

 **Country / Region:**
Guangdong, China ✓

 **Year Established:**
2004 ✓

 **Main Products:**
CNC Machining Parts, Stamping Pa... ✓

 **Main Markets:**
North America, Oceania, Mid East... ✓

 **Total Annual Revenue:**
confidential ✓

 **Total Employees:**
11 - 50 People ✓

Alibaba.com Gold Plus Supplier

Alibaba.com Gold Plus Supplier

Main Product Lines Verification Report

Verified

Assessment Report

Presented to

Presented to

Shenzhen Launch Co., Ltd.

Cooperation Company of Shenzhen Launch Co., Ltd.

深圳市朗驰商贸有限公司

深圳市朗驰商贸有限公司合作工厂

Company Address	B5003, Building 3, Yilida Building, No. 1092 Nanshan Avenue, Dengliang Community, Nanshan Street, Nanshan District, Shenzhen City, Guangdong Province, China
Consigner of Assessment:	Alibaba
Gold Supplier Member ID:	launch168
Gold Supplier Company Name:	Shenzhen Launch Co., Ltd.
Contact Person:	Mr. Binfeng Gao
Phone Number:	0086-13802569770
Fax Number:	0086-755-86372611
Email:	gbf999@china.com
Website Address (URL):	http://launch-china.en.alibaba.com

Gold Supplier & Assessed Company Relationship:	<input type="checkbox"/> Self-owned <input type="checkbox"/> Wholly Owned <input type="checkbox"/> Shareholder/Partner <input type="checkbox"/> Kindred between Owners <input checked="" type="checkbox"/> Cooperation Partner
Company Address	Confidential
City / Country:	Huizhou / China
Consigner of Assessment:	Alibaba & Shenzhen Launch Co., Ltd.
Gold Supplier Member ID:	launch168
Gold Supplier Company Name:	Shenzhen Launch Co., Ltd.
Contact Person:	Confidential
Phone Number:	Confidential
Fax Number:	Confidential
Email:	Confidential
Website Address (URL):	http://launch-china.en.alibaba.com

Service Provided by SGS
Report No.: 19536352_P+T

Service Provided by SGS
Report No.: 19552720_P



WHY CHOOSE US



15 YEARS EXPERIENCE

We have been manufacturing railing hardware since 2004.



ONE STOP SERVICE

We provide integrated railing solutions. We manufacture. We deliver.



PROFESSIONAL R&D TEAM

We have engineering experts for developing new products.



TOP QUALITY & GOOD PRICE

We are strict on quality control as well as cost evaluation.

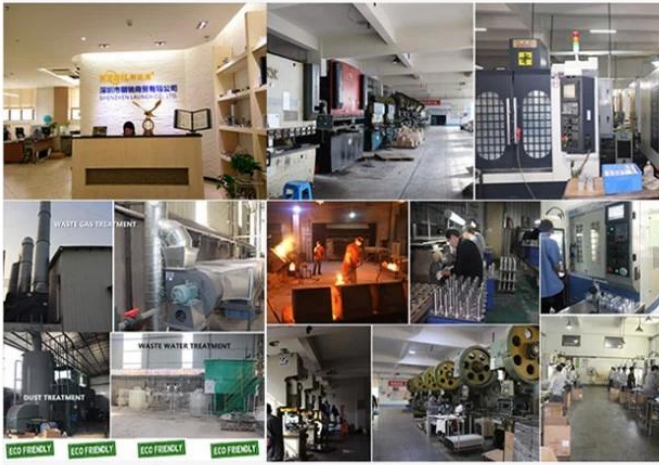

ABOUT US

Shenzhen Launch Co., Ltd was established in 2004, located at Nanshan District, Shenzhen, and one hour by car from Hongkong International Airport. Our main products are high-grade building materials including stainless steel balustrade post, staircase handrail, balcony guardrail, swimming pool fence and other high-grade building materials. All the products are designed strictly according to the high-end market requirements. We have our own factory in Tangxia Town, Dongguan, with more than 50 sets of various precision equipments, such as CNC lathe, milling machine, punching machine, pipe cutter, argon welder, drilling machine, polisher, etc. which can provide customers with complete product processing services.

Profil de garde-corps en U en aluminium pour chaussures de balustres de Guangzhou

Aluminium U canal balustrade profil Caractéristiques

- Matériau: aluminium 6063 T5
- Finition: anodisation
- Longueur: 4m par longueur ou longueur de la coutume
- Pour épaisseur de verre: verre trempé 12-21.52mm
- Vendu en kit: comprend les boulons, le canal en caoutchouc et les raccords

Canal en aluminium pour verre 12mm

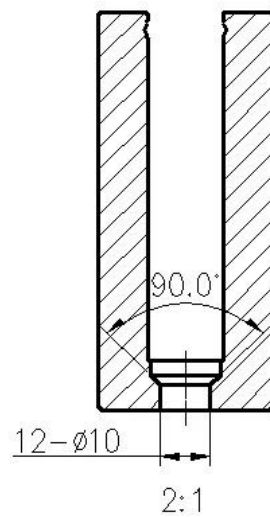
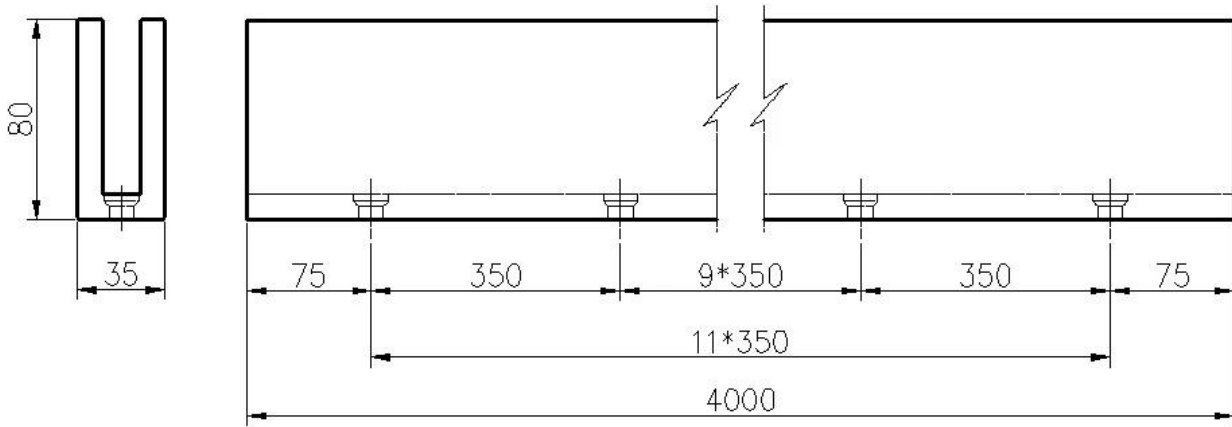
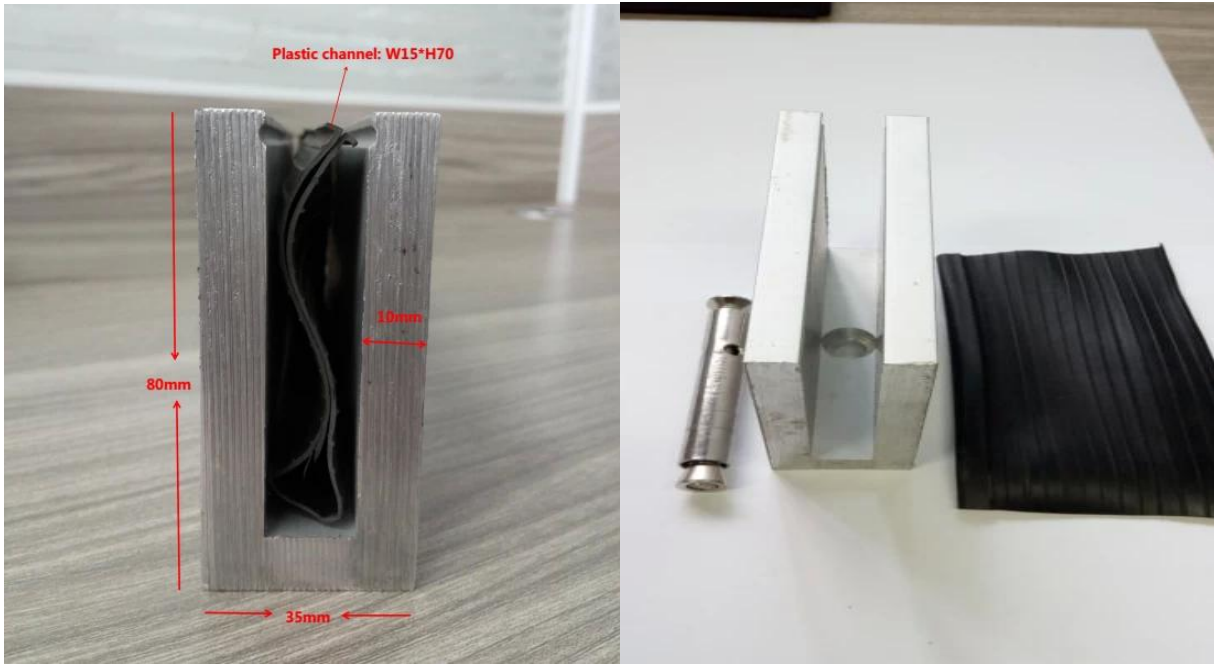

Installation du canal en aluminium U

installation

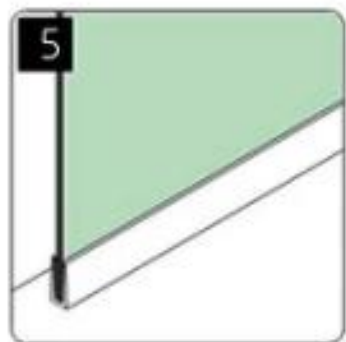
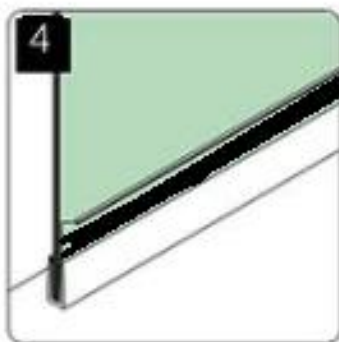
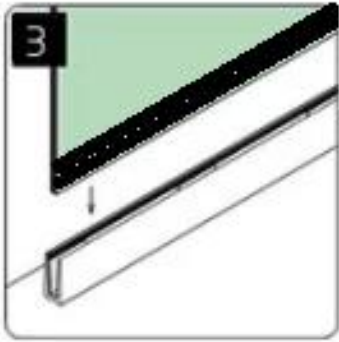
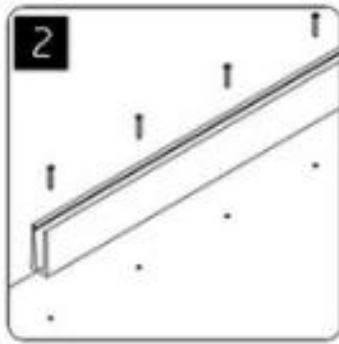
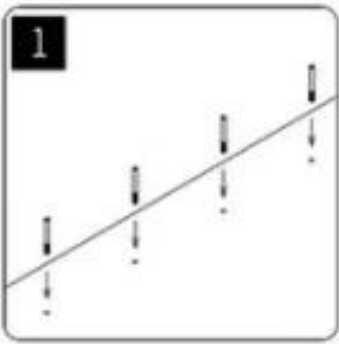

Autres modèles canal U en aluminium qui pourrait vous intéresser

LCH-C01



12 mm to 13.14 mm tempered glass

1 m aluminium groove contains the following accessories (excluding glass)



Aluminum trough 1 m Waterproof tape 2 meters

Aluminum plastic fittings 3 sets

Expansion screws 3 pieces

LCH-C02



12 mm to 13.14 mm tempered glass

1 m aluminium groove contains the following accessories (excluding glass)

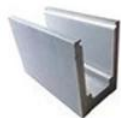

Aluminum trough 1 m Decorative cover 2 meters

Aluminum plastic fittings 3 sets

Expansion screws 3 pieces

LCH-D01



12 mm to 13.14 mm tempered glass

1 m aluminium groove contains the following accessories (excluding glass)



Aluminum trough 1 m Waterproof tape 2 meters Aluminum plastic fittings 3 sets Expansion screws 3 pieces

LCH-D02



12 mm to 13.14 mm tempered glass

1 m aluminium groove contains the following accessories (excluding glass)

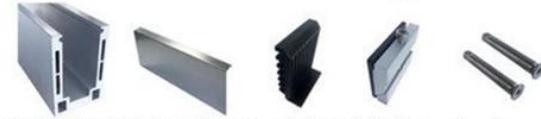

Aluminum trough 1 m Decorative cover 2 meters Aluminum plastic fittings 3 sets Expansion screws 3 pieces

LCH-B01



16 mm to 17.52 mm tempered glass

1 m aluminium groove contains the following accessories (excluding glass)



Aluminum trough 1 m Waterproof tape 2 meters Aluminum plastic fittings 3 sets Expansion screws 3 pieces

LCH-B02



16 mm to 17.52 mm tempered glass

1 m aluminium groove contains the following accessories (excluding glass)

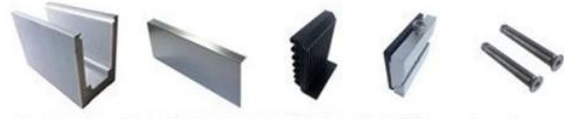

Aluminum trough 1 m Decorative cover 2 meters Aluminum plastic fittings 3 sets Expansion screws 3 pieces

LCH-A01



20 mm to 21.52 mm tempered glass

1 m aluminium groove contains the following accessories (excluding glass)



LCH-A02



20 mm to 21.52 mm tempered glass

1 m aluminium groove contains the following accessories (excluding glass)

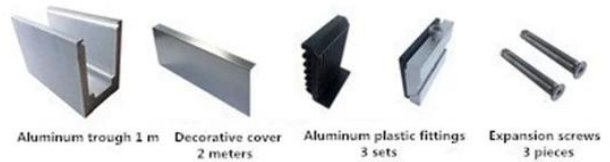

Photos du projet de garde-corps du canal U d'Alumnum







Package de canaux en aluminium



Apparenté, relié, connexe des produits - capsulage de main courante en verre en C en acier inoxydable



Contact

Merci pour votre visite ! Toute question ou demande, s'il vous plaît laissez un message. Je reviendrai vers vous dans les 24 heures.

Toute demande urgente, veuillez nous contacter ci-dessous:

-Contact: Doirs

-Email: sales04@launch-china.cn

-Bureau: (86-755) 86037559

-Mob / whats app: 0086-13530506265

-Skype: launch_04