

## Poteau de balustre carré en acier inoxydable pour balcons en verre



### 1. Spécifications du balustre à poteau carré en acier inoxydable :

<b>Produit prénom</b>	Poteau d'aiguille carré en acier inoxydable
<b>N ° de modèle</b>	LCH-121
<b>Matériel</b>	Acier inoxydable 304/316
<b>terminer</b>	Brossé ou miroir poli
<b>Taille du poteau carré</b>	50 x 50 x 1,5 mm d'épaisseur de paroi Épaisseur de paroi de 40 x 40 x 1,5 mm
<b>la taille</b>	Personnalisable
<b>Pour épaisseur de verre</b>	10-15mm
<b>Application</b>	Conception de balustrade de balcon Conception de balustrade de porche Conception de rampe de pont Conception de rampe d'escalier

Poteau d'extrémité avec raccord araignée 1 voie

Borne centrale avec raccord araignée 2 voies

Hauteur standard: 1100mm (le poste client est disponible)

Conçu pour le verre 10-15mm ou selon votre condition

Les angles réglables se détachent de la conception pour l'escalier ou le balcon etc.



2. Dessin de dimension de poteau d'araignée carré d'acier inoxydable Pour votre référence:

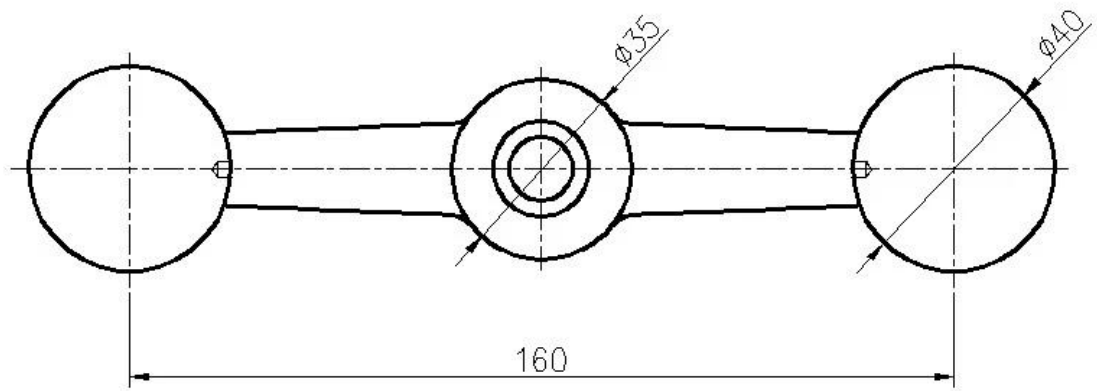
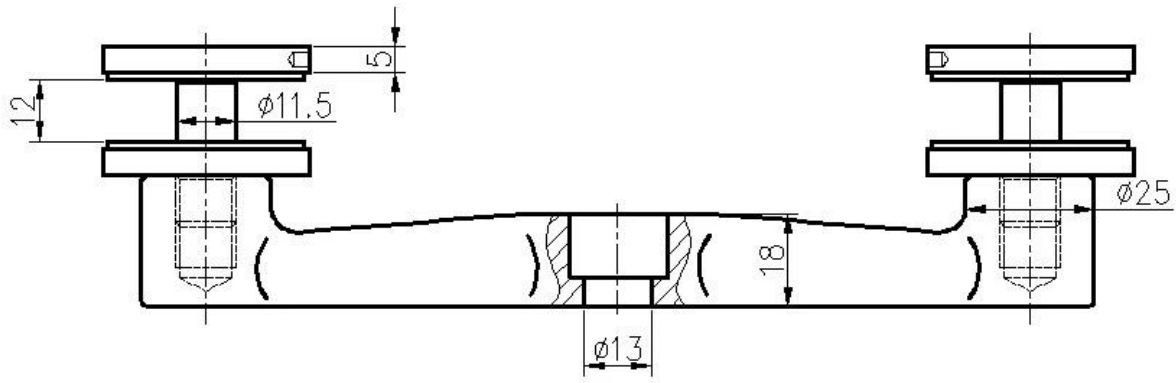

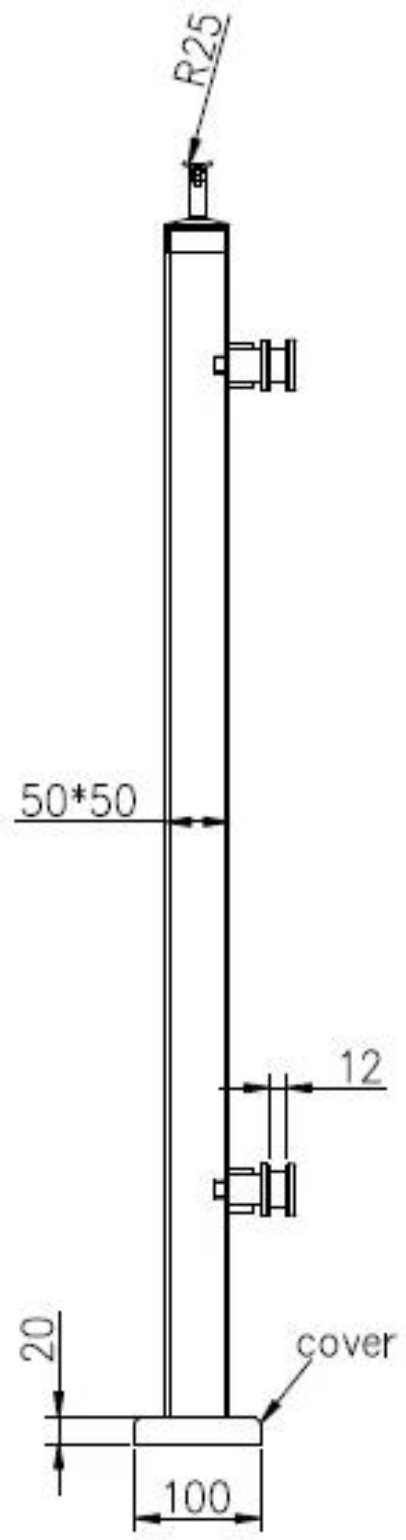
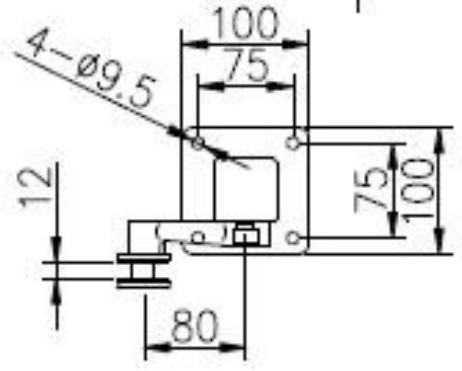
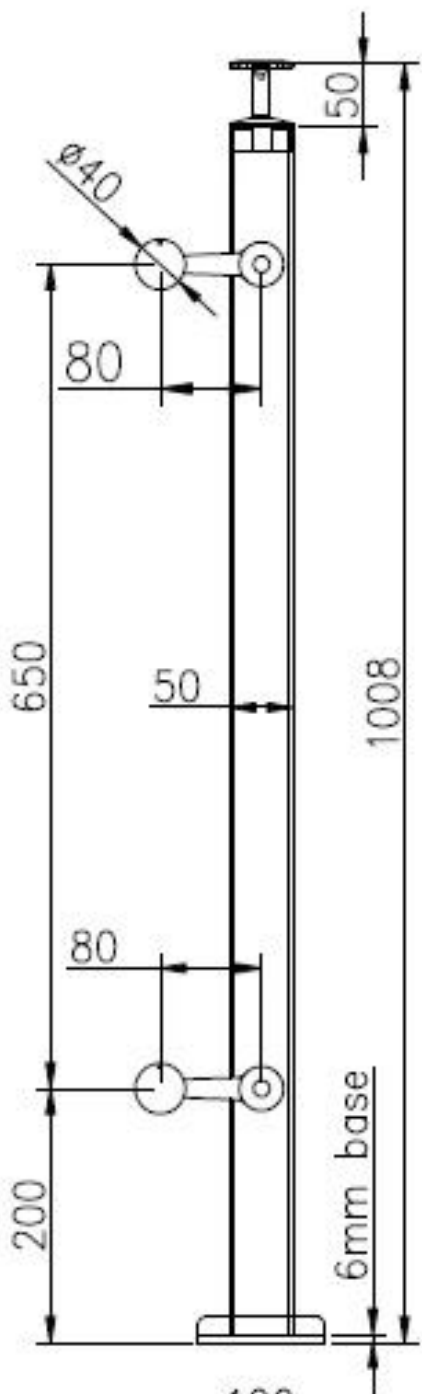

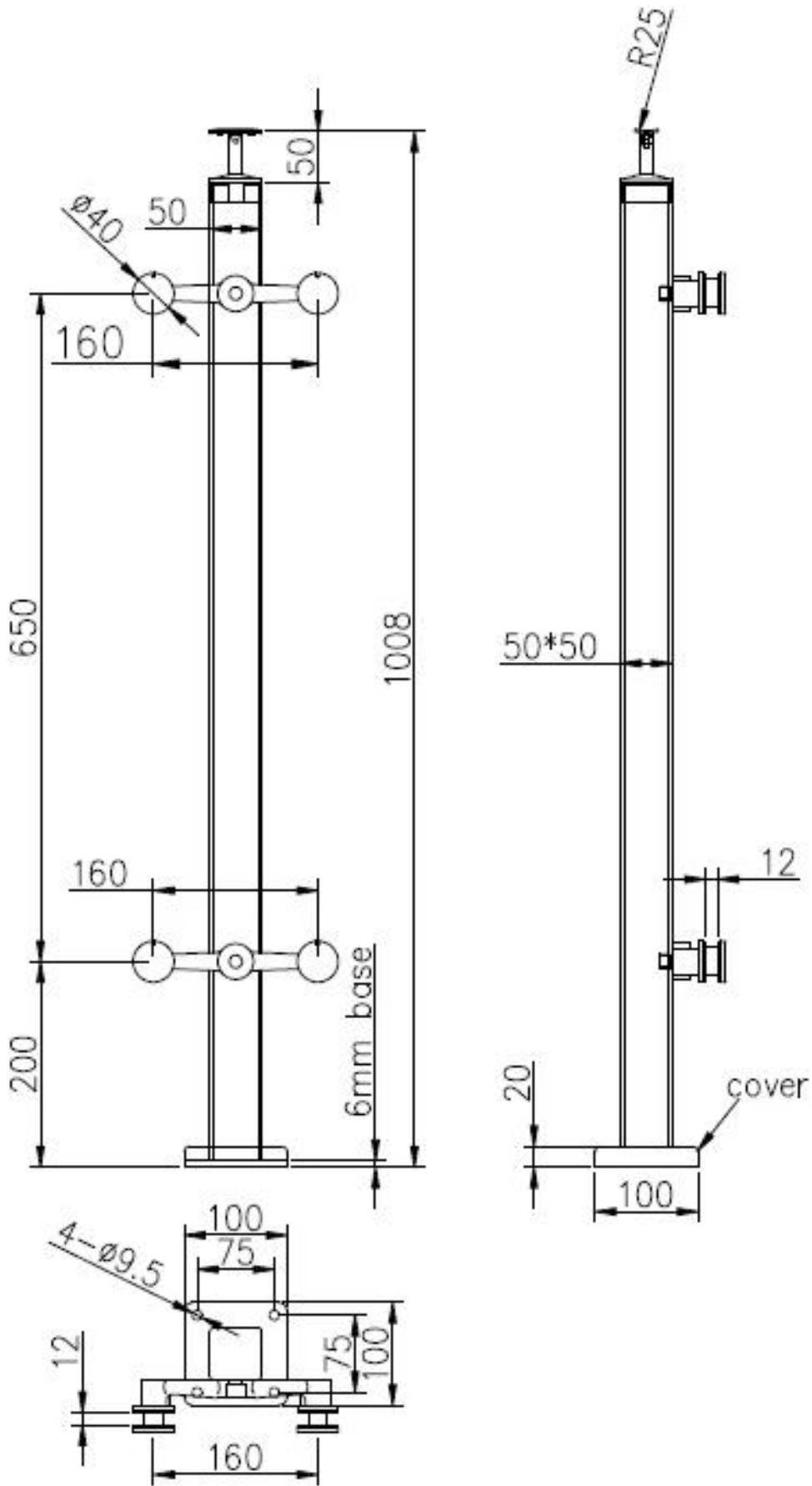

3. Poteau en acier inoxydable Balustre en poteau Photos:

Support de main courante réglable en hauteur pour main courante en tube carré ou rond:



Poste intermédiaire à deux voies:







1 voie de sortie:



4. Emballage Photos: 1 pc / sac en plastique, 2 - 4pcs / ctn.





Compagnie Information:

Shenzhen Launch Co., Ltd was established in 2004, located at Nanshan District, Shenzhen, and one hour by car from Hongkong International Airport. Our main product is high-grade building materials includes stainless steel balustrade post, staircase handrail, balcony guardrail, swimming pool fence and other high-grade building materials. All the products are designed strictly according to the high-end market requirements. We have our own factory in Tangxia Town, Dongguan, has a variety of precision equipment more than 50 sets: CNC lathe, milling machine, punching machine, pipe cutter, argon welder, drilling machine, polisher, etc. which can provide customers with complete product processing services. With the German SPECTRO Spectrometer, we insist on testing every batch of materials to ensure that the material is highly qualified. We also have hardness gauge, secondary element and other test equipment to ensure the products meets customers' requirements.

## ABOUT US

### Our Team



# OUR ADVANTAGE

Please do not hesitate to contact us if you have any requirement regarding our production lines, you can expect a timely reply with professional solutions!



Own factory, shortest lead time.



Can help customers design product drawings based on customer ideas and design engineering installation drawing according to the customer site sketch.



Sample order, trial order acceptable.



Provide material test report to ensure that the material is qualified.



13 years of industry experience, we can help customers recommend the best solution to help customers save cost.

# OUR FACTORY

More than 13 years experience in hardware industry design and processing, we can provide customized services from design to the sample and small batch trial production.



# OUR CERTIFICATE

With premium quality, competitive price and superior service, we won a lot of customers' favor.  
Our products are popular in North America, European and Australia.



# PRODUCTION PROCESS



Casting



CNC lathe



CNC Milling



Stamping



Drilling & Tapping



Polishing





# ***PACKAGING & DELIVERY***



# PAYMENT & TRANSPORTATION

Welcome Alibaba Trade Assurance Order!

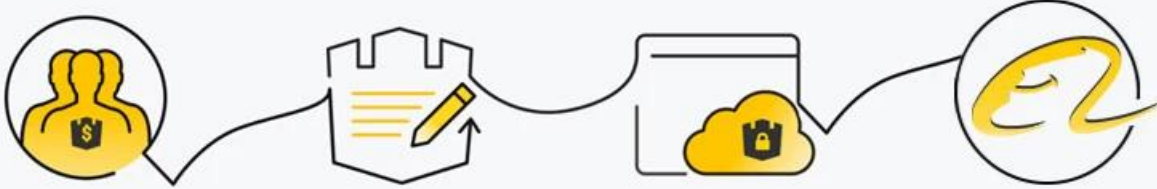

1 Start an order

2 Negotiate terms with our sales service & confirm order

3 Make payment

4 Alibaba provide full assurance



S'il vous plaît nous contacter librement pour plus d'informations:

Email: [sales03@launch-china.cn](mailto:sales03@launch-china.cn)

Contact: Eve Chow

WhatsApp / HP: +8615907334556