

Description

--Charnière lourde porte acier inoxydable pour le verre arrondir la balustrade de verre sans cadre post semi

--Modèle No.:G-R2

--Pour le verre au poste de 50,8 mm de diamètre en acier inoxydable/aluminium

--Méthode de fabrication: casting

--Peut contenir ≤ 20 KG verre (1000x1000x8mm)

--Emballage: un pc dans un sac en plastique, puis dans une boîte. 12 pcs dans un carton.

--MOQ: un pc

--Livraison: par air/mer

--Clôture de piscine demande: coffre fort, balcon design, garde-corps, verre à [rondes en acier inoxydable post](#), verre à [aluminium rond post](#), balustrade de verre sans cadre semi

--Pour commercial et décoration de la maison moderne

--Pour les gros et de détail (nous sommes usine)

--L'échantillon est toujours disponible

Détails du produit

Finition de sarin



Finition de miroir



Verre percé trou de dessin

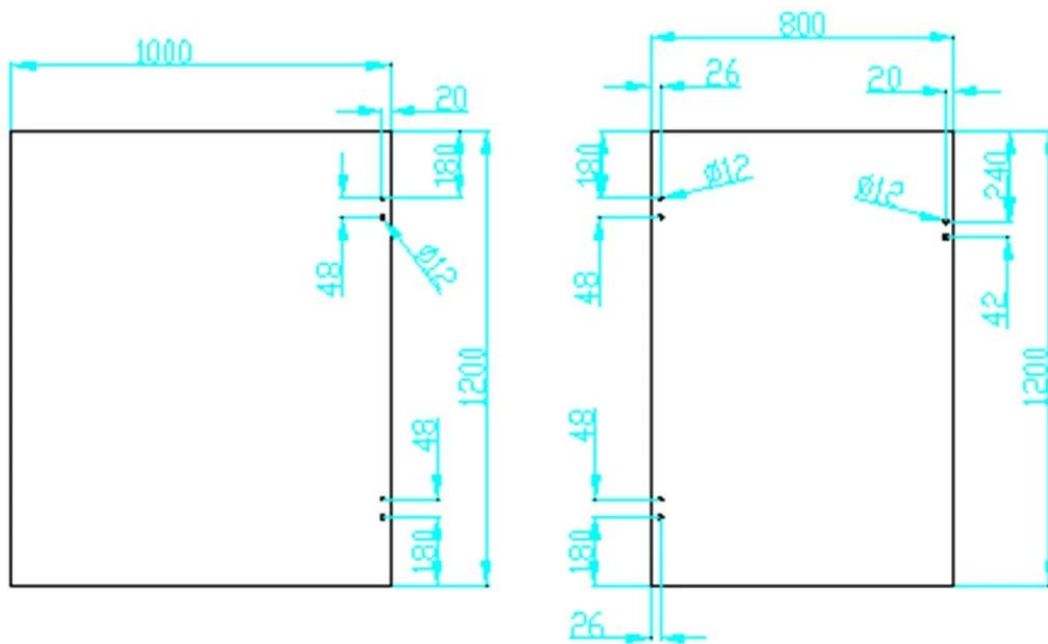

Projet

Charnière de verre est habituellement couplée à [robinet de verre](#) et [loquet de verre](#)

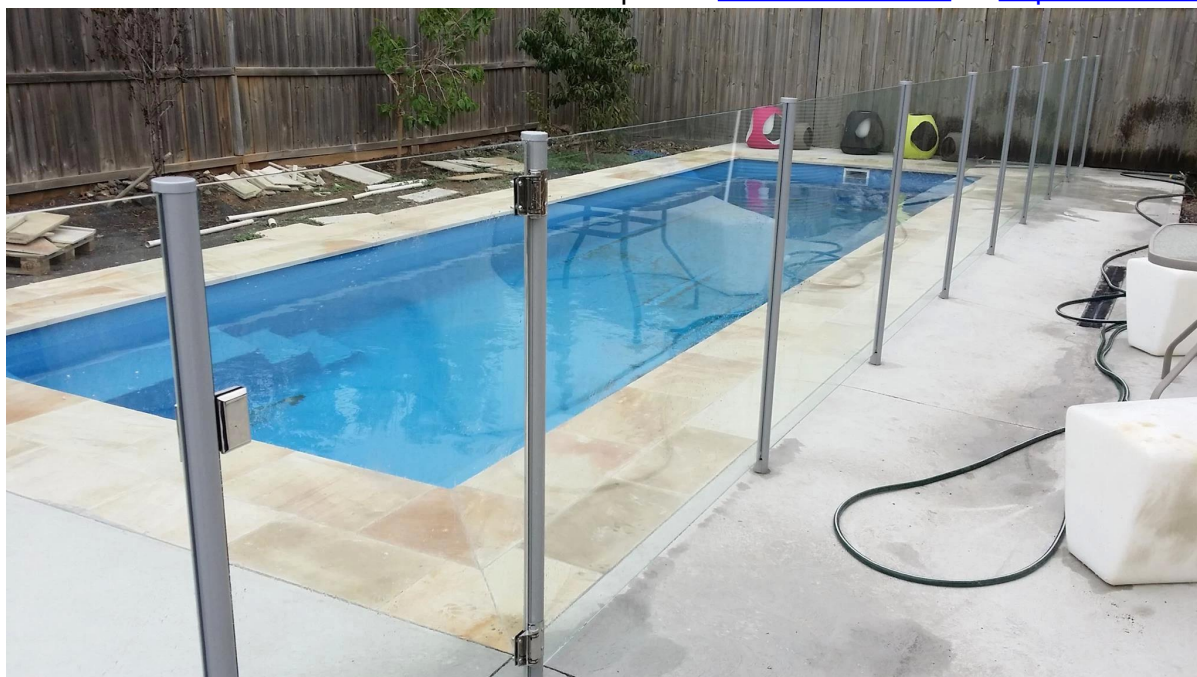











Pour les photos de la projet de clôture dans la piscine plus beautiful, aller [ici](#)

Emballage & livraison

- Un pc dans un sac en plastique, puis dans une boîte.
- Délai d'exécution régulière: 10-15 jours après paiement. Il est fonction de la quantité.
- Délai de livraison: 5-7 jours par exprès. 15-20 jours de mer.

packing	plastic bag+box+carton
production lead time	30-45 days ; also depending on your qty.
Shippment	 
	   
payment	 



Usine & Certification





Besoin d'un devis ou des questions? Veuillez laisser un message.
Ou me contacter en dessous info. va revenir vers vous dès que possible!

KEBIL 科比奥

深圳市朗驰商贸有限公司
SHENZHEN LAUNCH CO., LTD.

朗驰国际有限公司
LAUNCH INTERNATIONAL LIMITED.

董萍 Doris Dong

Senior Sales Representative

☎ (86) 135 3050 6265

深圳市南山区南山大道1092号亿利达大厦B区3栋5003

Room 5003, Building 3, Yilida Building, No.1092
Nanshan Road, Nanshan District, Shenzhen, China
postal code 518054

☎ (86-755) 8603 7559

☎ (86-755) 8637 2611

✉ sales04@launch-china.cn

🌐 www.launch-china.com

🌐 www.chinabalustrade.com