

Ζεστό Πώληση Εσωτερική Μπαλκόνι Αίθριο Προστατευτική Γυαλί / U κανάλι Προφίλ αλουμινίου για γυάλινη κιγκλιδώματα

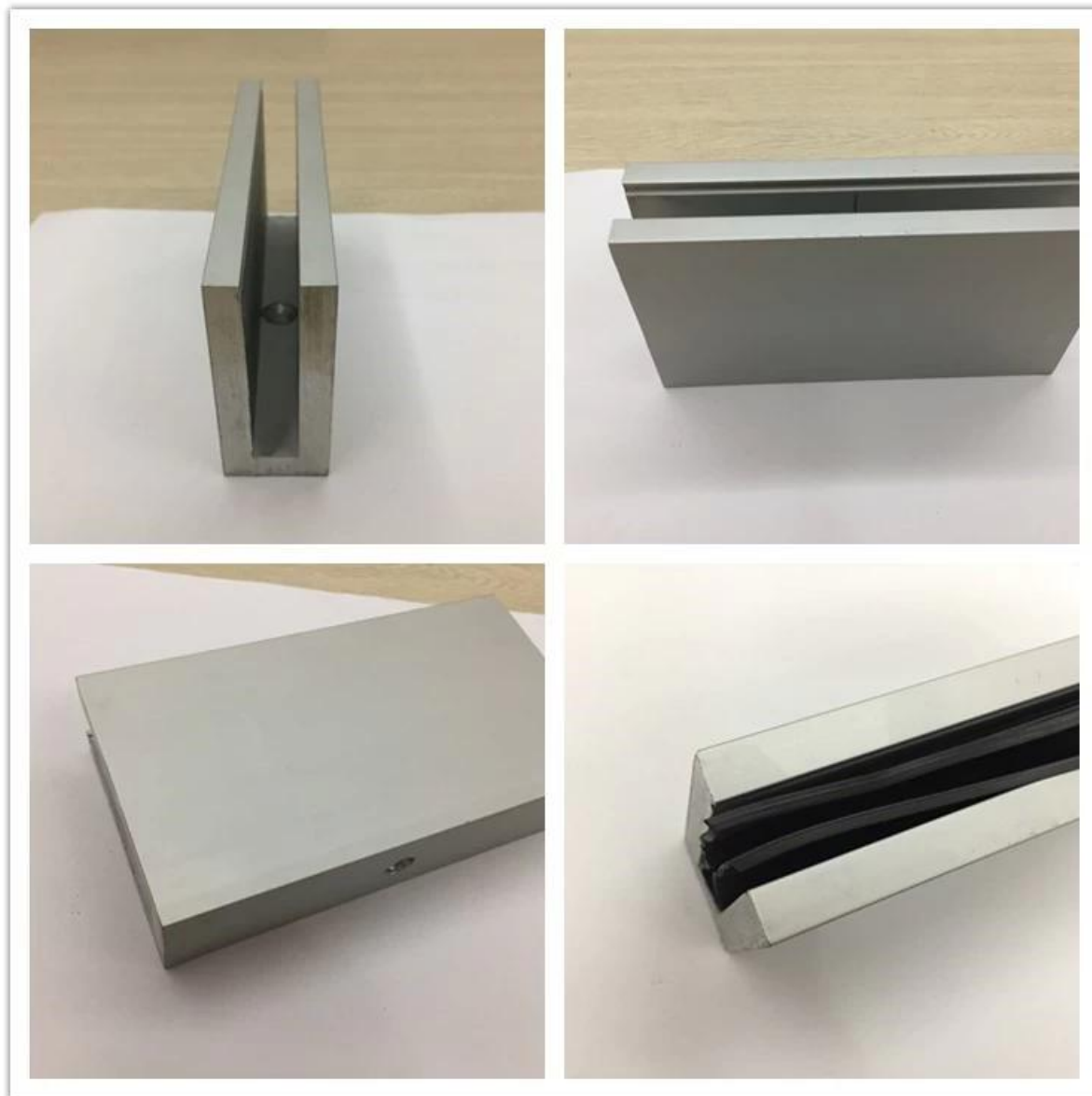

Προδιαγραφές προφίλ καναλιού αλουμινίου U:

Είδος	Αλουμινίου U κανάλι σκληρυμένο γυαλί μπαλκονόπορτας, U κανάλι υαλοπινάκων
Υλικό	Αλουμίνιο 6063 T3
Φινίρισμα	Ανοδιωμένο / επικαλυμμένο με σκόνη
Μέγεθος	35 * 80mm / 63,5 * 104mm κλπ
Πάχος γυαλιού	12mm έως 25mm
Τύποι σωλήνων υποδοχής	Γύρω ή τετράγωνο
Εγκατάσταση	αυτόματες βίδες / βίδες έκρηξης / βίδες
Βάση	τοποθετημένο στο δάπεδο / τοίχου
Εφαρμογή	μπαλκόνι, κατάστρωμα, βεράντα, σκάλα, βεράντα, λόμπι, εμπορικό κέντρο
Διανομή	15-30 ημέρες

Για εμπορικές και οικιακές εφαρμογές
Για χονδρικού και λιανικού εμπορίου (Είμαστε κατασκευαστής)

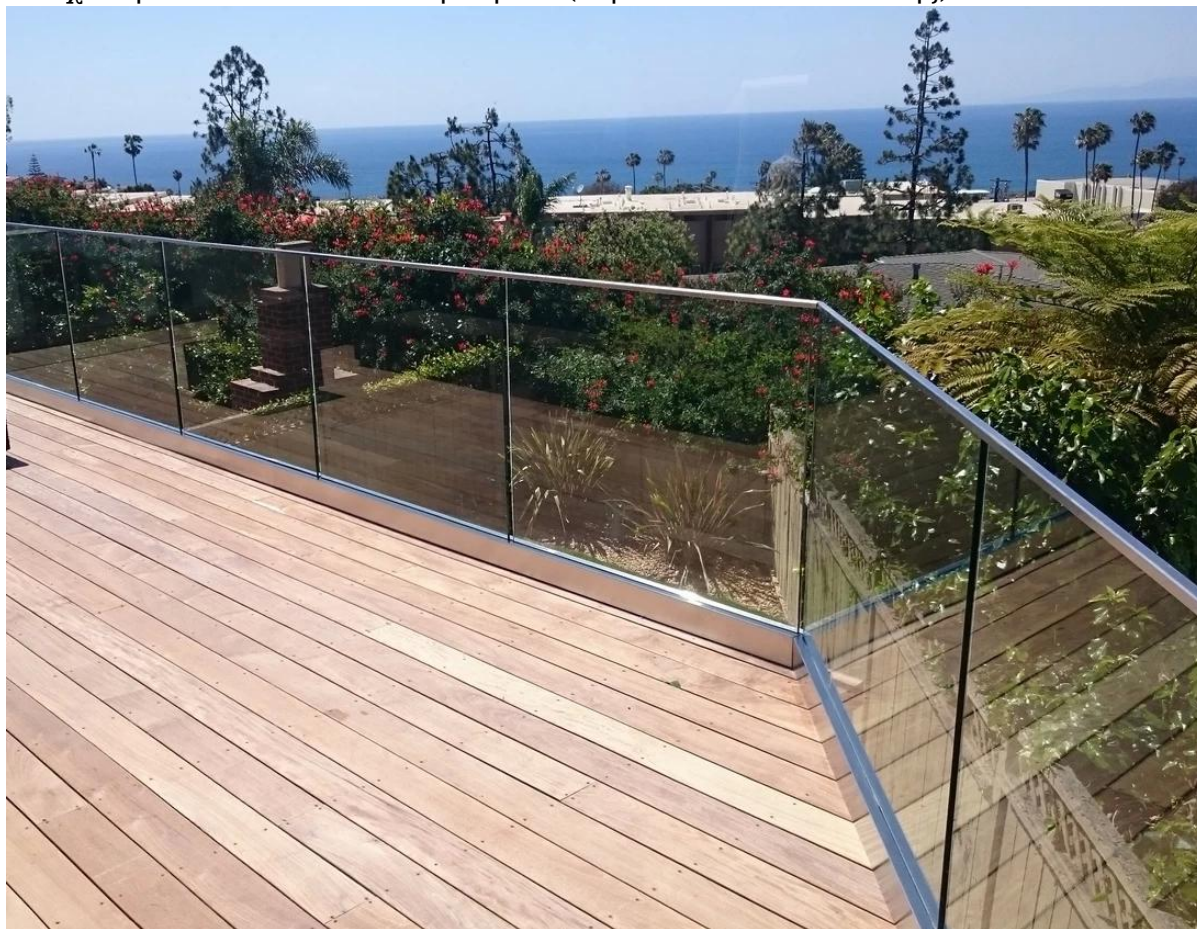

SMALL & ΚΑΝΑΛΙ ΜΕΓΑΛΟΥ ΤΥΠΟΥ ΑΛΟΥΜΙΝΙΟΥ U ΓΙΑ ΓΥΑΛΙΣΤΙΚΗ ΚΑΤΑΣΚΕΥΗ:

Small profile: for glass thickness 10-12.76mm

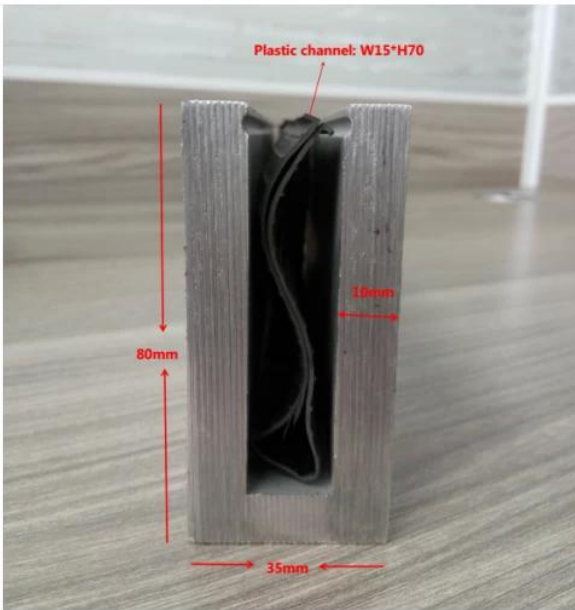

Big profile: for glass thickness 20-30mm

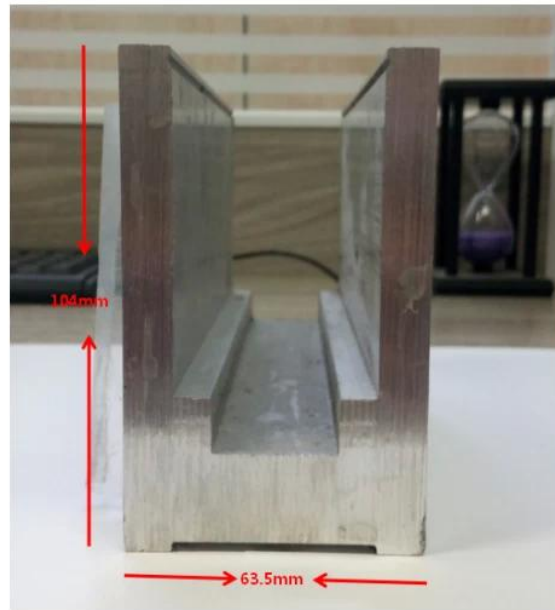

ΣΧΟΛΙΚΟΣ ΣΩΛΗΝΑΣ ΣΩΛΗΝΑΣ:



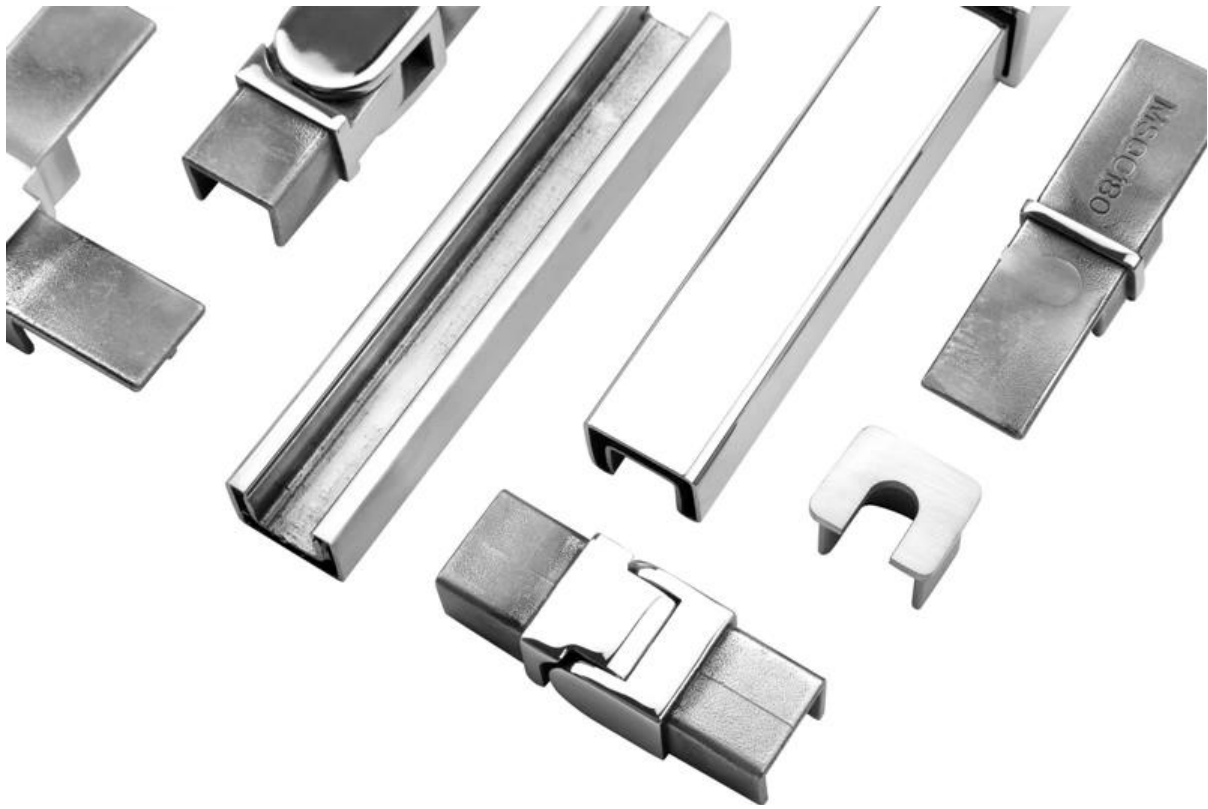

KEBIL 科比奥®



installation

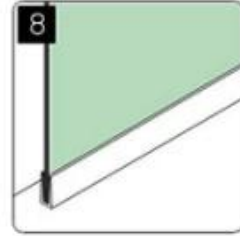
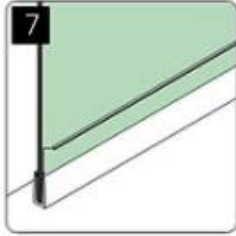
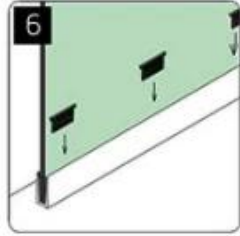
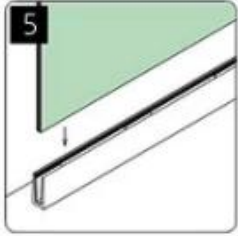
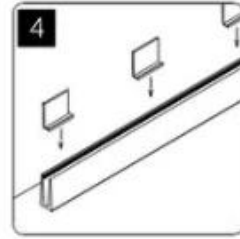
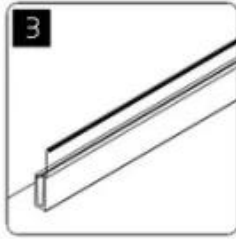
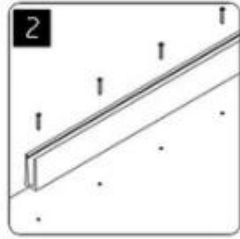
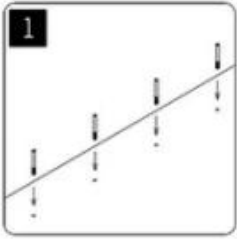

Shenzhen Launch Co., Ltd was established in 2004, located at Nanshan District, Shenzhen, and one hour by car from Hongkong International Airport. Our main product is high-grade building materials includes stainless steel balustrade post, staircase handrail, balcony guardrail, swimming pool fence and other high-grade building materials. All the products are designed strictly according to the high-end market requirements. We have our own factory in Tangxia Town, Dongguan, has a variety of precision equipment more than 50 sets: CNC lathe, milling machine, punching machine, pipe cutter, argon welder, drilling machine, polisher, etc. which can provide customers with complete product processing services. With the German SPECTRO Spectrometer, we insist on testing every batch of materials to ensure that the material is highly qualified. We also have hardness gauge, secondary element and other test equipment to ensure the products meets customers' requirements.

ABOUT US



OUR ADVANTAGE

Please do not hesitate to contact us if you have any requirement regarding our production lines, you can expect a timely reply with professional solutions!



Own factory, shortest lead time.



Can help customers design product drawings based on customer ideas and design engineering installation drawing according to the customer site sketch.



Sample order, trial order acceptable.



Provide material test report to ensure that the material is qualified.



13 years of industry experience, we can help customers recommend the best solution to help customers save cost.

OUR FACTORY

More than 13 years experience in hardware industry design and processing, we can provide customized services from design to the sample and small batch trial production.



OUR CERTIFICATE

With premium quality, competitive price and superior service, we won a lot of customers' favor.
Our products are popular in North America, European and Australia.



PRODUCTION PROCESS



Casting



CNC lathe



CNC Milling



Stamping



Drilling & Tapping



Polishing



PAYMENT & TRANSPORTATION

Welcome Alibaba Trade Assurance Order!



1 Start an order

2 Negotiate terms with our sales service & confirm order

3 Make payment

4 Alibaba provide full assurance



XPL FedEx[®]
Express

EMS[®]

DHL

TNT



Συχνές ερωτήσεις

1. Είστε εργοστάσιο;

Ναι, είμαστε εργοστάσιο.

2. Προσφέρετε δωρεάν δείγματα;

Ναι, προσφέρουμε δωρεάν δείγματα, αλλά οι πελάτες πρέπει να πληρώσουν ρητές χρεώσεις.

3. Τι υλικά έχετε;

Έχουμε το υλικό από ανοξείδωτο ατσάλι 304, 316, 316L και Duplex 2205.

4. Ποιο είναι το MOQ σας;

Το MOQ της απαιτούμενης παραγγελίας είναι 1 τεμ.

5. Τι είδους πληρωμή δέχεστε;

Δεχόμαστε την πληρωμή των T / T, LC, PayPal, West Union κ.λπ.

6. Ποιος είναι ο όρος πληρωμής σας;

Ο όρος πληρωμής μας είναι T / T (100% ή 30/70) ή LC στο θέαμα.

7. Ποιος είναι ο χρόνος παράδοσης;

Ο χρόνος παράδοσης είναι από 5 ημέρες έως 30 ημέρες για την ποσότητα σας.

8. Προσφέρετε OEM & Υπηρεσία ODM;

Ναι προσφέρουμε υπηρεσίες OEM & ODM.

9. Προσφέρετε υπηρεσία μετά την πώληση;

Ναι, προσφέρουμε εξυπηρέτηση μετά την πώληση. Κάθε καταγγελία για παραγγελίες θα εξεταστεί εγκαίρως εντός 12 ωρών.

Επικοινωνήστε μαζί μας τώρα για περισσότερες πληροφορίες:

Παραμονή

Email: sales03@launch-china.cn

Mobile / Whatsapp: +8615907334556