

316 roestvrijstalen vierkante wandgemonteerde glazen klemknipbeugelhouder op getemperd of gelaagd glas

productnaam	316 roestvrijstalen vierkante wandgemonteerde glazen klemknipbeugelhouder op getemperd of gelaagd glas
Grootte	W65 * D65 * (mm)
Voorglasdikte	10 mm of 12 mm
Materiaal	SUS304, SUS316
Oppervlakte behandeling	Satijnen geborsteld, spiegel gepolijst of zwart
Pakket	Individueel in plastic zak, standaard karton voor buitenverpakking
Certificaat	ISO 9001-2000
Gebruik	(1) Gebruik voor constructie en leuning. (2) in winkelcentrum, huis. Railing glazen klemmen
Kenmerken	Gemaakt van roestvrij staal, mooie vooruitzichten, gemakkelijk schoon te maken, van goede kwaliteit etc.
Gerelateerde zoekwoorden	Glazen klem / roestvrijstalen glazen klem / roestvrij stalen klem / glas balustrade klem / glas naar muurhouder 90 graden
Toepassing	Decoratie, op grote schaal gebruikt op roestvrijstalen balustrade en leuning. Binnen- of buitendecoraties.
Doorlooptijd	2-4 weken.
Moq	100 stuks.

Haven: Shenzhen, China

Handelsvoorwaarden beschikbaar: FOB, CIF, C & F, CFR, Ex-Works

Betalingsvoorwaarden beschikbaar: T / t; L / c op zicht; Western Union, Alibaba Escrow

Productafbeeldingen:

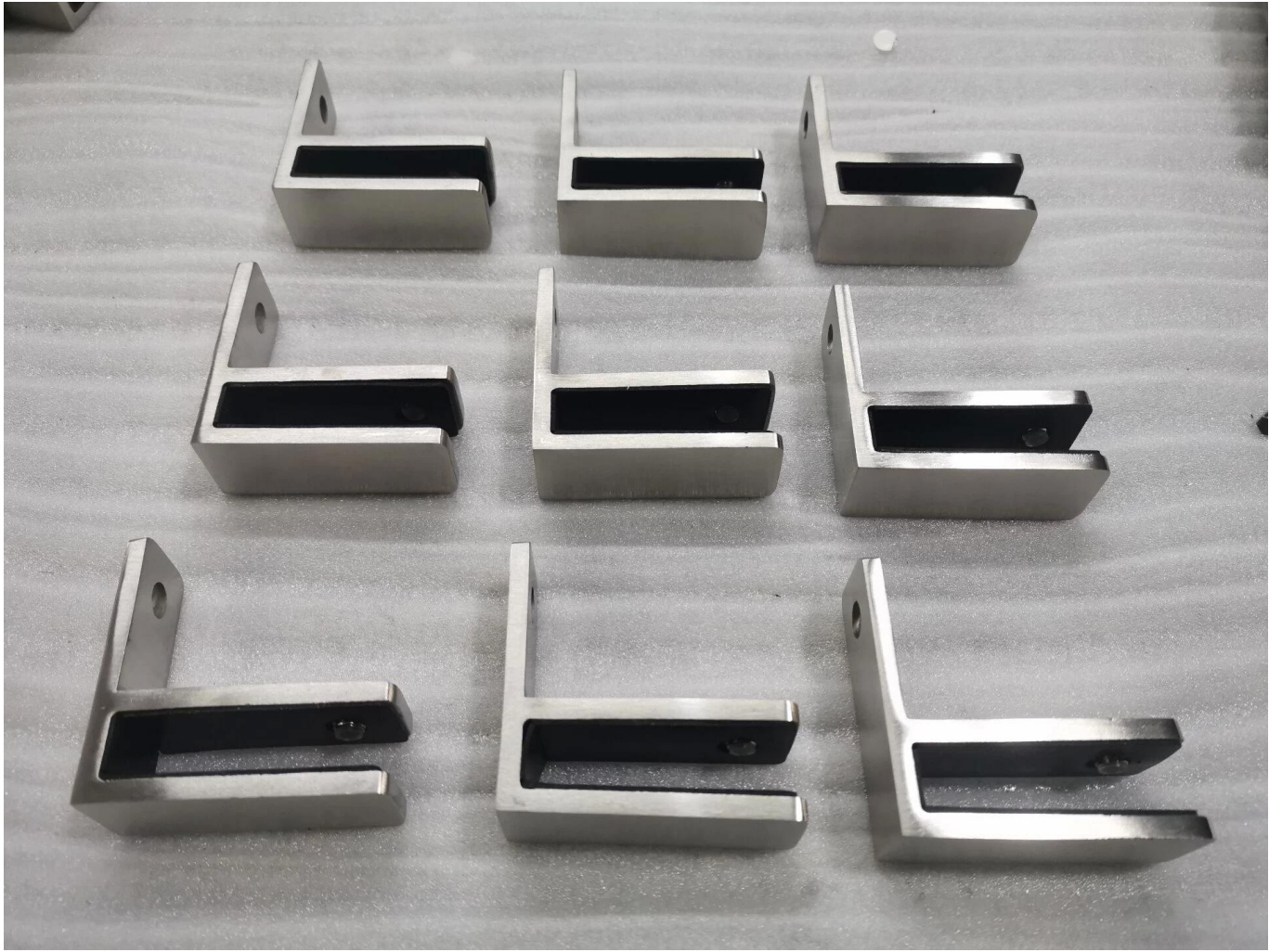

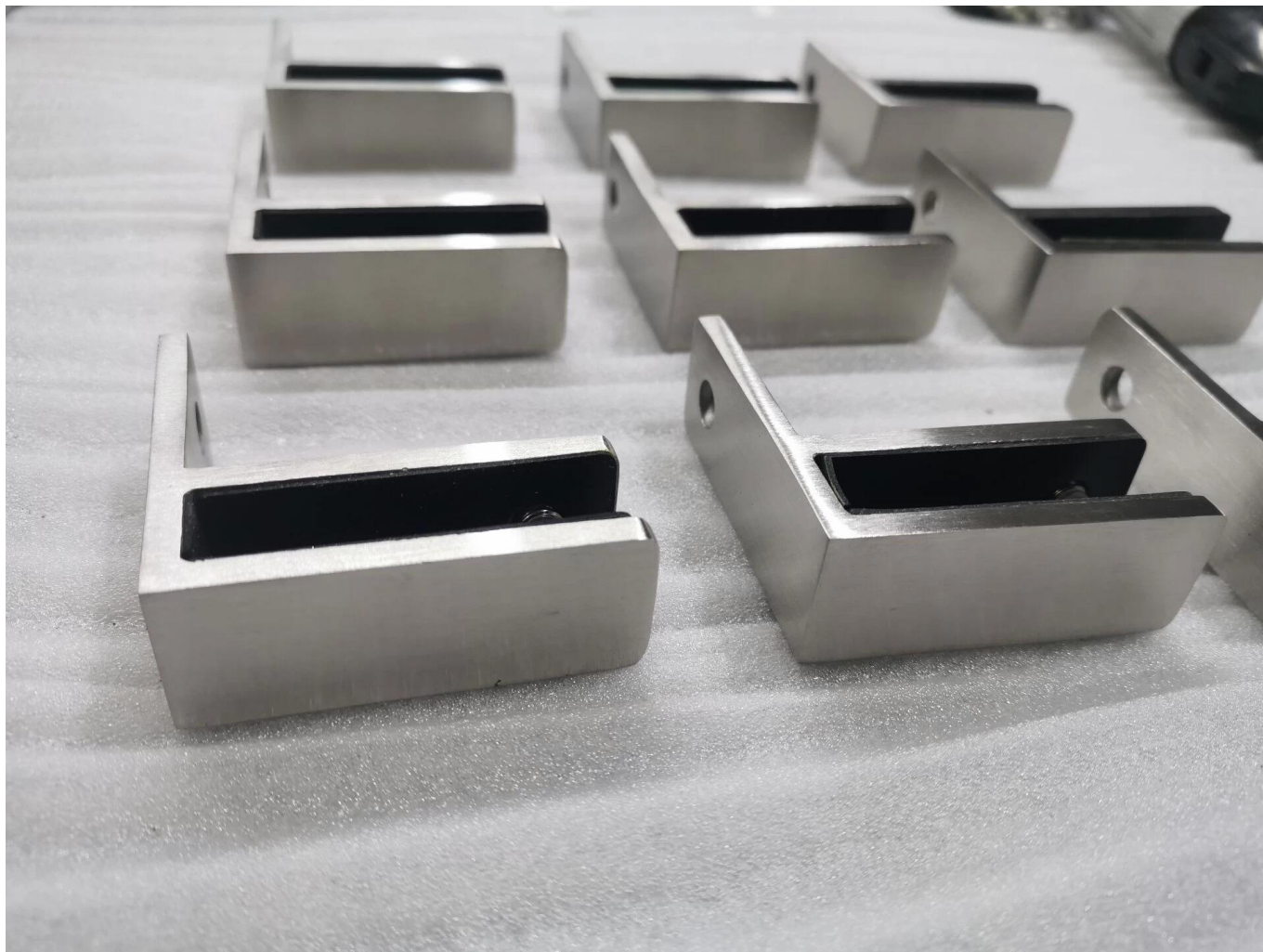

Technische tekening:

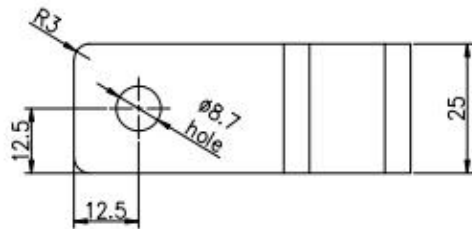
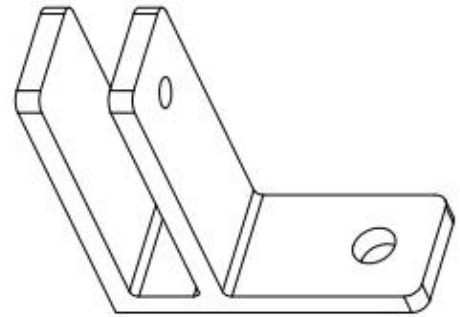
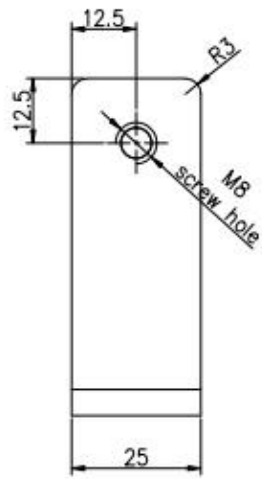
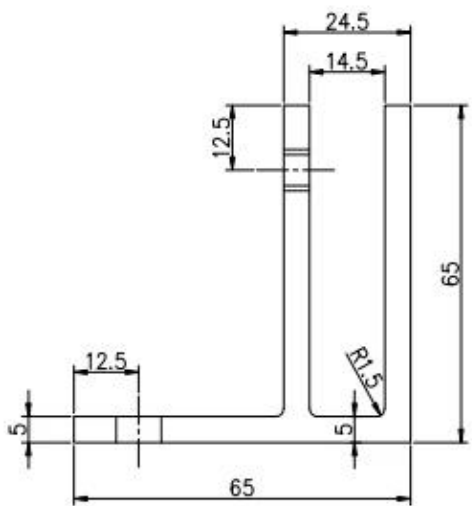

Glass TO WALL HOLDER 90°

MeerVerwantProducten:

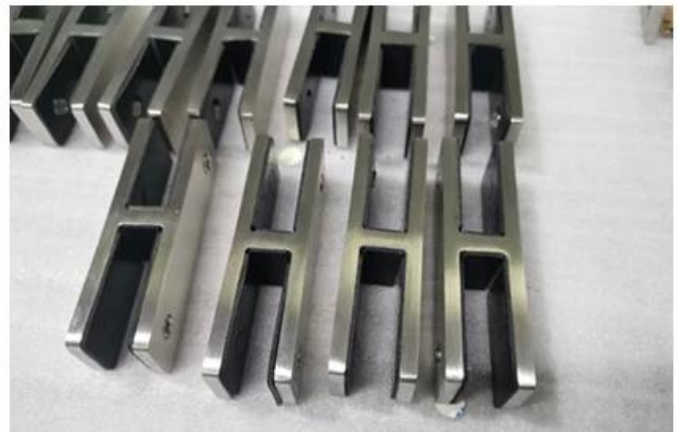
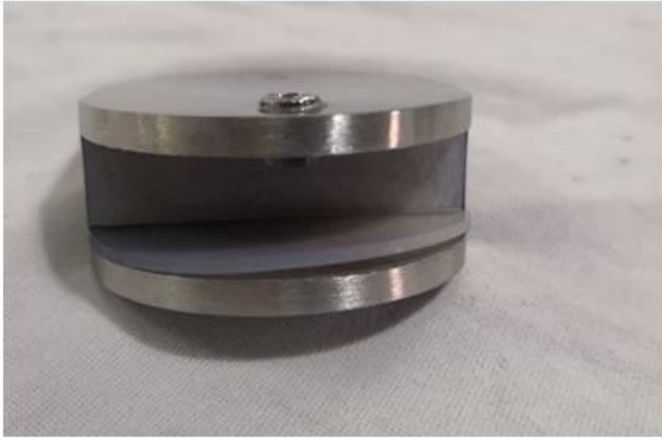

Zwarte geëgaliseerde / gepoedercoate afwerking:



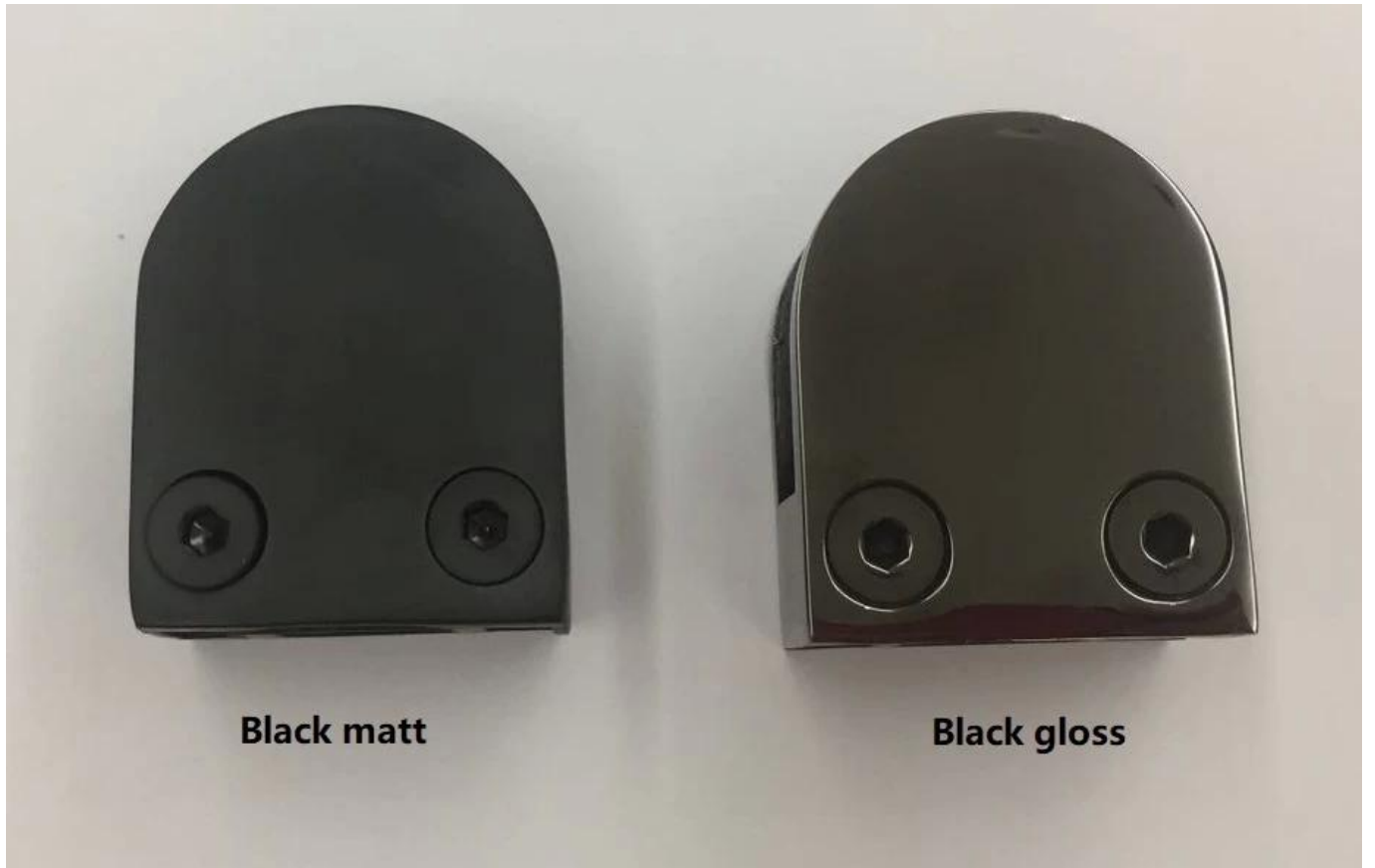

Verschillende soorten glazen klemmen met afmetingen:



G102



G103/G104



G105



G108R



PV-90



CB-180



BC-60



BC-80x35



CB-90

Specifications of all glass clamps in our company

Drawing	Picture	Ref.	A	B	C	D	E
		G108	55	55	25	11	0
		G108R	58	55	30	11	R25.4
		G101	51	41	25	11	0
		G101R	55	41	25	11	R21.5/R25.4
		G102	44	44	25	11	0
		G102R	48	44	25	11	R21.5/R25.4
		G103	50	40	22	8	0
		G104	50	40	26	12	0
		G105	54	45	28	14	0
		G107	63	45	28	14	0
		G103R	52	40	22	8	R21.5
		G104R	52	40	26	12	R21.5
		G105R	58	45	28	14	R21.5/R25.4
		G107R	66	45	28	14	R21.5/R25.4
		G106	50	40	25	12	0
		G106R	52	40	25	12	R21.5/R25.4

Dit type glazen railingklem kan worden bevestigd aan vierkante post en muur.



De glazen railingklem gebruikt meestal met roestvrijstalen post om glazen panelen vast te houden,
Voor balkonrailing, terrastraliewerk, trap. Geschikt voor zowel binnen- als buiten.



WAAROM VOOR ONS KIEZEN:

1. Hoge kwaliteit van leuning, reling en glazen klem;
2. Modeontwerp en volledige productlijn;
3. Concurrerende prijs en eenvoudig te installeren;
4. Materiaal: roestvrij staal 316 of roestvrij staal 304;
5. Klantontwerp: ons ervaren ingenieursteam kan de producten en vervaardiging in overeenstemming met monsters, tekeningen of alleen ideeën;
6. Voor meer leuning-fittingen, roestvrijstalen reling en glazen klem, stuur ons dan een e-mail voor de volledige catalogus.

Neem onmiddellijk contact met ons op voor meer informatie!

E-mail: sales03@launch-china.cn

MOB: +8613686807796