

# 1. Beschrijving

--RVS 304/316 leuning beugel houder glazen balustrade

--Afwerking: mirror of Satijn

--Verschillende grootte beschikbaar is (Stuur ons tekening en aantal om ons te helpen offerte)

# 2. product afbeelding

## Leuning beugel catalogus

STAINLESS STEEL BALUSTRADE AND FITTINGS



SHENZHEN LAUNCH CO., LTD

STAND OFF



SF-30

Model No. : SF-30	
Material	Stainless steel 304/316
Finish	Satin / mirror polished
Size	30*10mm cap, 30*25mm body, M8*100 bolt, silicon rubber gasket included

Model No. : SF-50



SF-50

Model No. : SF-50	
Material	Stainless steel 304/316
Finish	Satin / mirror polished
Size	50*10mm cap, 50*30 mm body, M12*120 bolt, silicon rubber gasket included

Model No. : SF-50 T



SF-50 T

Model No. : SF-50 T	
Material	Stainless steel 304/316
Finish	Satin / mirror polished
Size	50*10mm cap, 50*30 mm body, silicon rubber gasket included
Mounting plate size	200*160*10mm

HANDRAIL BRACKET



P701

Model No. : P701	
Material	Stainless steel 304/316
Finish	Satin / mirror polished



P701R

Model No. : P701R	
Material	Stainless steel 304/316
Finish	Satin / mirror polished



P702

Model No. : P702	
Material	Stainless steel 304/316
Finish	Satin / mirror polished

http://www.chinabalustrade.com



P703R

Model No. : P702R	
Material	Stainless steel 304/316
Finish	Satin / mirror polished



P703

Model No. : P703	
Material	Stainless steel 304/316
Finish	Satin / mirror polished



P704R

Model No. : P703R	
Material	Stainless steel 304/316
Finish	Satin / mirror polished



P704

Model No. : P704	
Material	Stainless steel 304/316
Finish	Satin / mirror polished



P705R

Model No. : P705R	
Material	Stainless steel 304/316
Finish	Satin / mirror polished



P705

Model No. : P705	
Material	Stainless steel 304/316
Finish	Satin / mirror polished



P706R

Model No. : P706R	
Material	Stainless steel 304/316
Finish	Satin / mirror polished



P706

Model No. : P706	
Material	Stainless steel 304/316
Finish	Satin / mirror polished



P707R

Model No. : P707R	
Material	Stainless steel 304/316
Finish	Satin / mirror polished



P707

Model No. : P707	
Material	Stainless steel 304/316
Finish	Satin / mirror polished



P708R

Model No. : P708R	
Material	Stainless steel 304/316
Finish	Satin / mirror polished



P708

Model No. : P708	
Material	Stainless steel 304/316
Finish	Satin / mirror polished



P709R

Model No. : P709R	
Material	Stainless steel 304/316
Finish	Satin / mirror polished



P709

Model No. : P709	
Material	Stainless steel 304/316
Finish	Satin / mirror polished

Nieuw ontwerp product

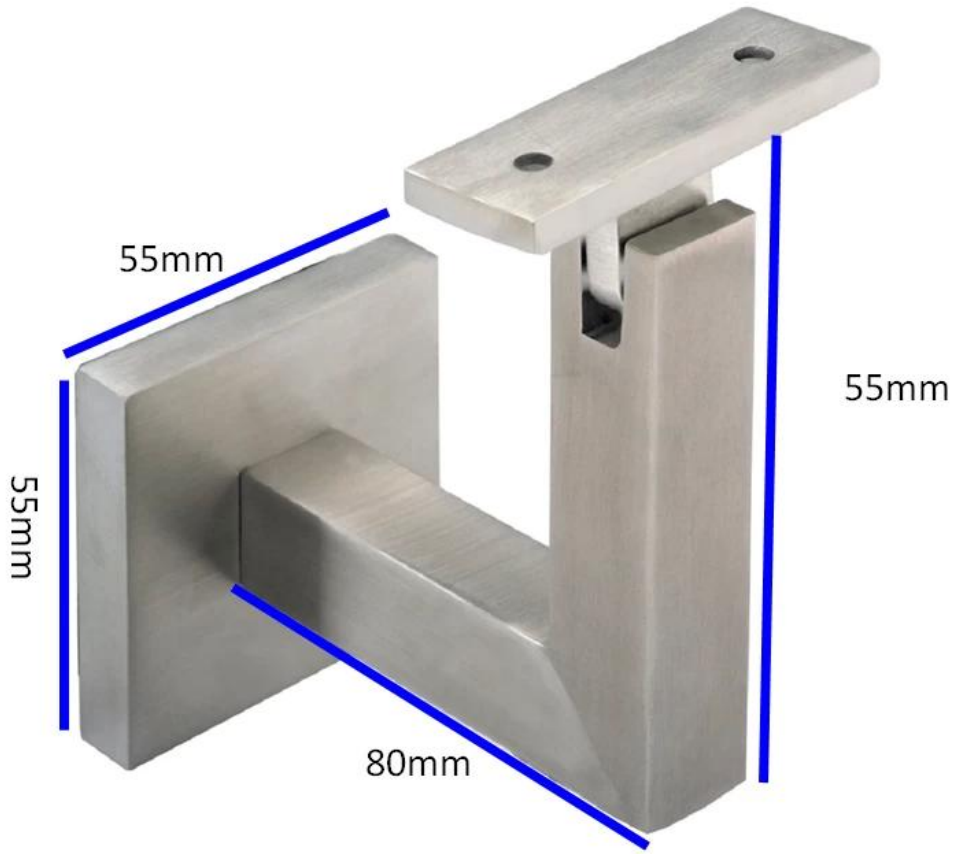



Verstelbare leuning haken



3. details







Leuning brackt + SS tube ontwerp (we aanpassen SS buis)



Hnadrail beugel + [gehard glas](#)





Leuning beugel + [Standoff](#) ontwerp











#### 4. levering & verpakking

--Levering: 3-5 dagen door express. 10-15 dagen door de scheepvaart

--Verpakking: een pc in een plastic zak, dan in een doos.

--Overlappendtijd: ongeveer 20 dagen na betaling. (Het depent op de hoeveelheid)



packing	plastic bag+box+carton
production lead time	30-45 days ; also depending on your qty.
Shippment	 
	 
	 
payment	 

5. aanverwante producten

[Vierkante buis-connector](#)

5. fabriek & certificering





## 6. klanten





**build &  
renovating  
expo**

Friday 4 July - Sunday 6 July 2014  
Melbourne Exhibition Centre



## 7. contact



KEBIL 科比奥®

深圳市朗驰商贸有限公司  
SHENZHEN LAUNCH CO., LTD.

朗驰国际有限公司  
LAUNCH INTERNATIONAL LIMITED.

**董萍** Doris Dong

Senior Sales Representative

☎ (86) 135 3050 6265

---

深圳市南山区南山大道1092号亿利达大厦B区3栋5003

Room 5003, Building 3, Yilida Building, No.1092  
Nanshan Road, Nanshan District, Shenzhen, China  
postal code 518054

---

☎ (86-755) 8603 7559

☎ (86-755) 8637 2611

✉ sales04@launch-china.cn

🌐 www.launch-china.com

www.chinabalustrade.com

Dank u voor uw bezoek. Doe niet heasite om ons te contacteren voor de fabriek directe prijs en professioneel adviseert.