

Lage prijs glazen balustrade aluminium profiel U-basiskanaal

Productomschrijving

Product Name	Lage prijs glazen balustrade aluminium profiel U-basiskanaal
Materiaal	Aluminium 6063 T5
Af hebben	Anodiseren / poedercoaten
Voor Glass Thickness	10-12 mm glas
Lengte	4 m per lengte of lengte van de klant
Wordt als bouw pakket verkocht	Inclusief rubberen kanaal en spreidbouten
Montage	Verdieping montage of kernboormontage
Grootte	35x80mm
Details over de verpakking	Bellenzak - karton - pallet
Toepassing	Zwembadhek / balkon / terras / trap U-kanaal glazen balustrade
Fabrieksinspectie	Beschikbaar
Sruim	Beschikbaar
MOQ	Een stukje. U kunt bestellen volgens uw taak vereiste.
OEM en ODM Onderhoud	Beschikbaar

Aluminium U-kanaal Vernietigt

1) Glazen balustrade aluminium U-profiel tekening en installatie

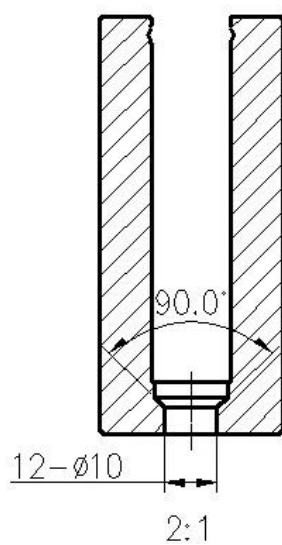
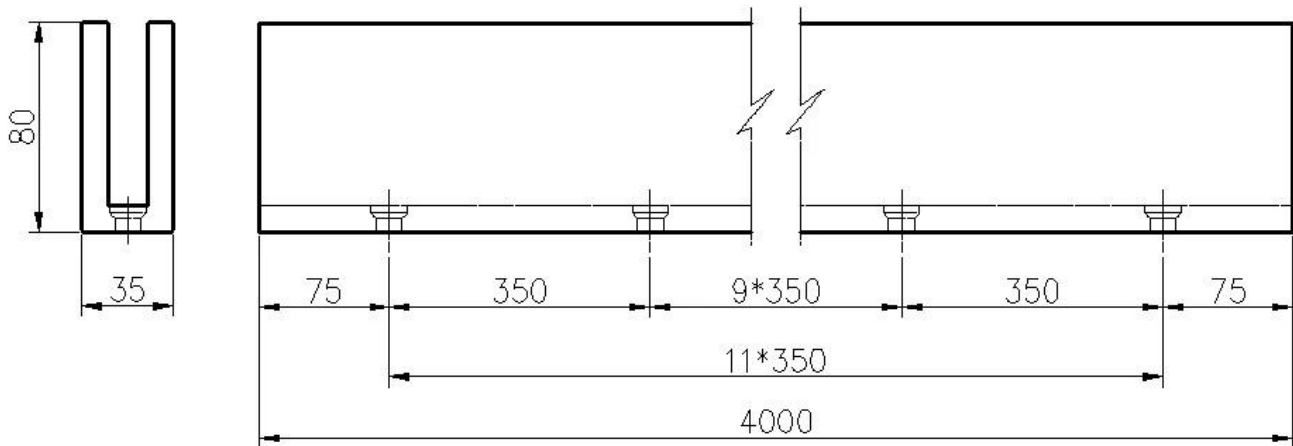

installation

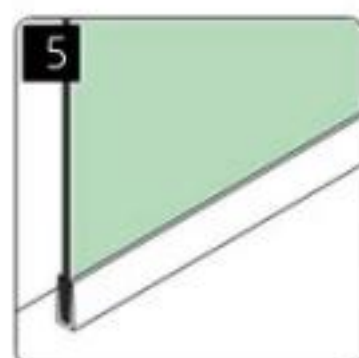
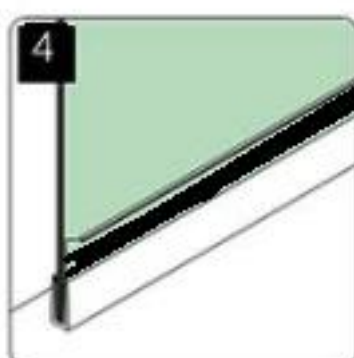
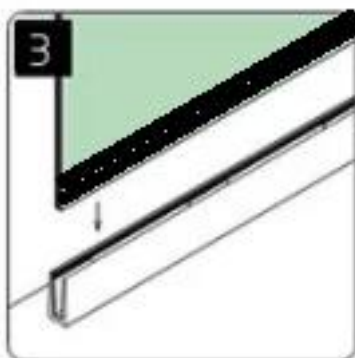
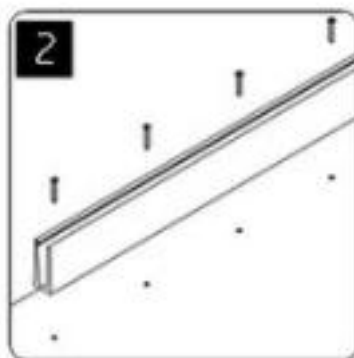
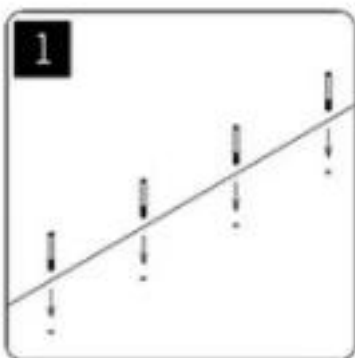

2) Glazen balustrade aluminium U-kanaal details

A. glazen balustrade U-kanaal voor 10-12 mm glas

u channel: 25*80mm
rubber channel: 15*70mm



A set of U channel:
-aluminum channel
-rubber channel
-screws fixing into ground

bottom view

top view

side view

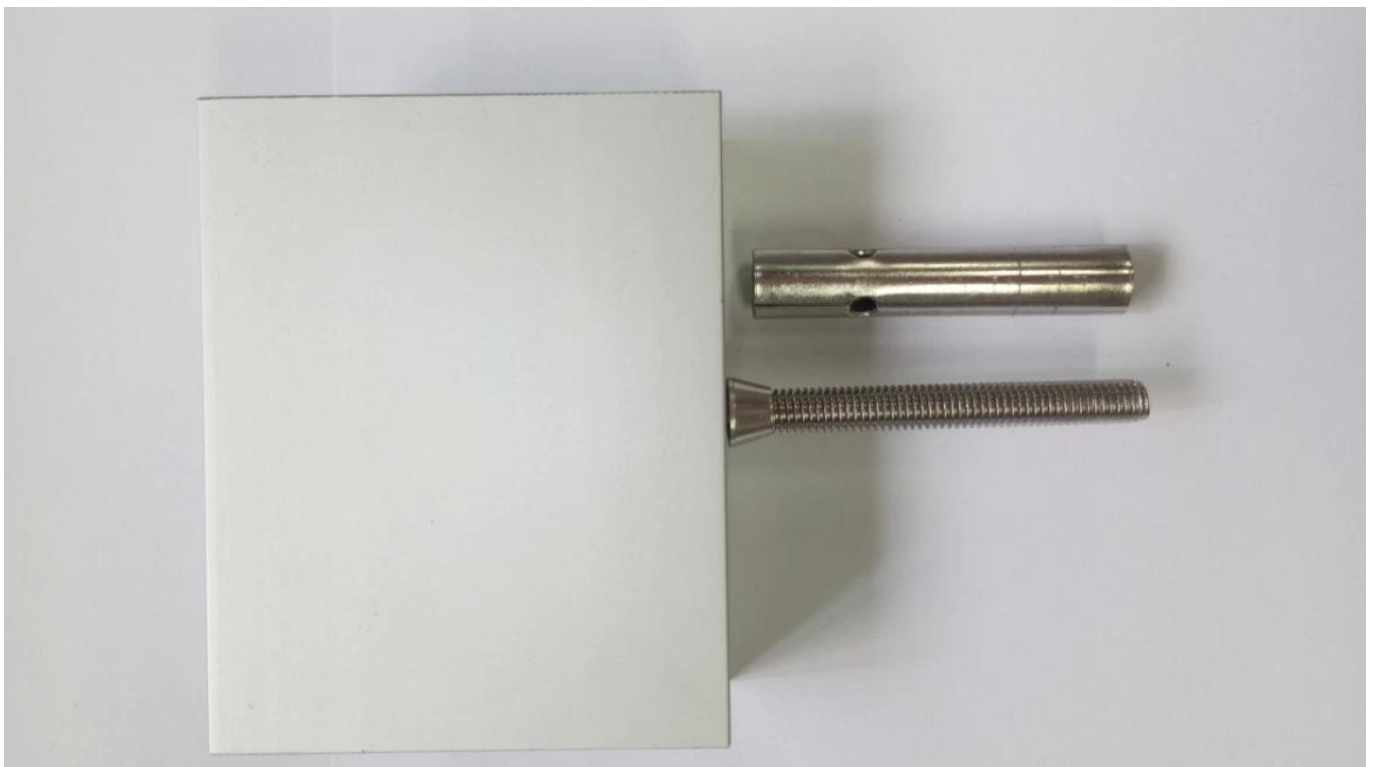

Glazen balustrade aluminium profiel U basiskanaal veiligheidspakket

Of verpakking als eisen van de klant.



Glazen balustrade U-kanaal projecten





**gerelateerde
producten**

Roestvrij staal verwijderbaar top hand- het spoor Hoes:



**Dia25.4mm slotted handrail tube
14x14mm groove**



180 degree joiner



90 degree joiner



wall-rail joiner



end cap

25x20mm slotted handrail tube
14x14mm groove



180 degree joiner



90 degree joiner



wall-rail joiner



vertical adjustable joiner



horizontal adjustable joiner



end cap

FAQ

1. welk materiaal heb je?

SS304, SS316, SS316L, duplex 2205, ect.

2. Kunt u mij uw hele prijslijst sturen?

Sorry, aangezien de prijs verband houdt met vele factoren, zoals hoeveelheid, materiaal soort, oppervlaktebehandeling, enzovoort, zullen we u een exacte offerte aanbieden nadat we uw gedetailleerde vereisten hebben bevestigd.

Biedt u OEM & ODM-service aan?

Ja, we kunnen de producten maken op basis van uw technische tekeningen of monsters. Wij zijn professioneel in het gieten van investeringen, spuitgieten, stempelen, CNC-bewerking, enz.

4. Wat voor soort betaling accepteert u?

T / T, L / C, PayPal, West Union, enz.

5. Wat is uw betalingstermijn?

T / T (30/70) of L / C op zicht.

6. wat is uw levertijd?

Binnen 5 werkdagen voor hot-sale artikelen. 15-25 werkdagen voor badbestellingen.

7. Biedt u service na verkoop aan?

Bij elke vraag nadat u onze producten heeft gekocht, nemen we natuurlijk binnen 24 uur contact met u op.

Neem contact met ons op voor meer informatie:

-Contactpersoon: Eve Zhou

-Skype: launch_03

-E-mail: sales03@launch-china.cn

-Mob / wat is APP: +8613686807796