

Beschrijving

- Vierkante basisplaat toplager SBM-2 voor roestvrij staal volledig frameleze glazen railing systeem
- Materiaal: RVS 316, 316L, duplex2205
- Vierkante basis dimention: 100x100mm
- Voor glasdikte: 10-13.52 mm (leveren wij ook glas toplager voor 15-16 mm glas)
- Te houden 1500mm breed glas, hight \leq 1200mm.
(als glas hight > 1200mm, core boormachine ronde en vierkante toplager is aanbevolen)
- Toepassing: veilige kristalheldere zwembad omheining, balkon frameless trapleuning, dek glazen reling, Tuin RVS hekwerk, achtertuin roestvrij stalen reling.
- Voor zowel commercial en modern huis huisontwerp
- Voor zowel groothandel en retail (We zijn fabriek)
- Monster is altijd beschikbaar
- Kracht test hebben doorlopen

Producten-details

spiegelend oppervlak



Satijn oppervlak



Project foto 's







aanverwante producten: [glazen deur klink](#), [glazen DEURSCHARNIER](#), [sleuf leuning buis](#)

Ga voor meer glazen balustrade inspiation, [HIER](#)

Verslag van de beproeving van de sterkte

Results Summary

(For details of individual tests, refer to the tables on the following pages.)

ID	Item/Heat No.	Dimensions/Type/Details	Finish	Overall Assessment
14117/01	SSBM316	180mm High, 50mm Square, Base Plate 316 Stainless steel	316L	COMPLIES

Remarks

After completion of the testing, the spigot was found to be in sound condition with no breakage, tearing or signs of fracture and no looseness of the fixings.

Colin Lorrimar
Metallurgical Testing Manager



Accreditation No. ~~14117~~ 14117
Accredited for compliance
with ISO/IEC 17025



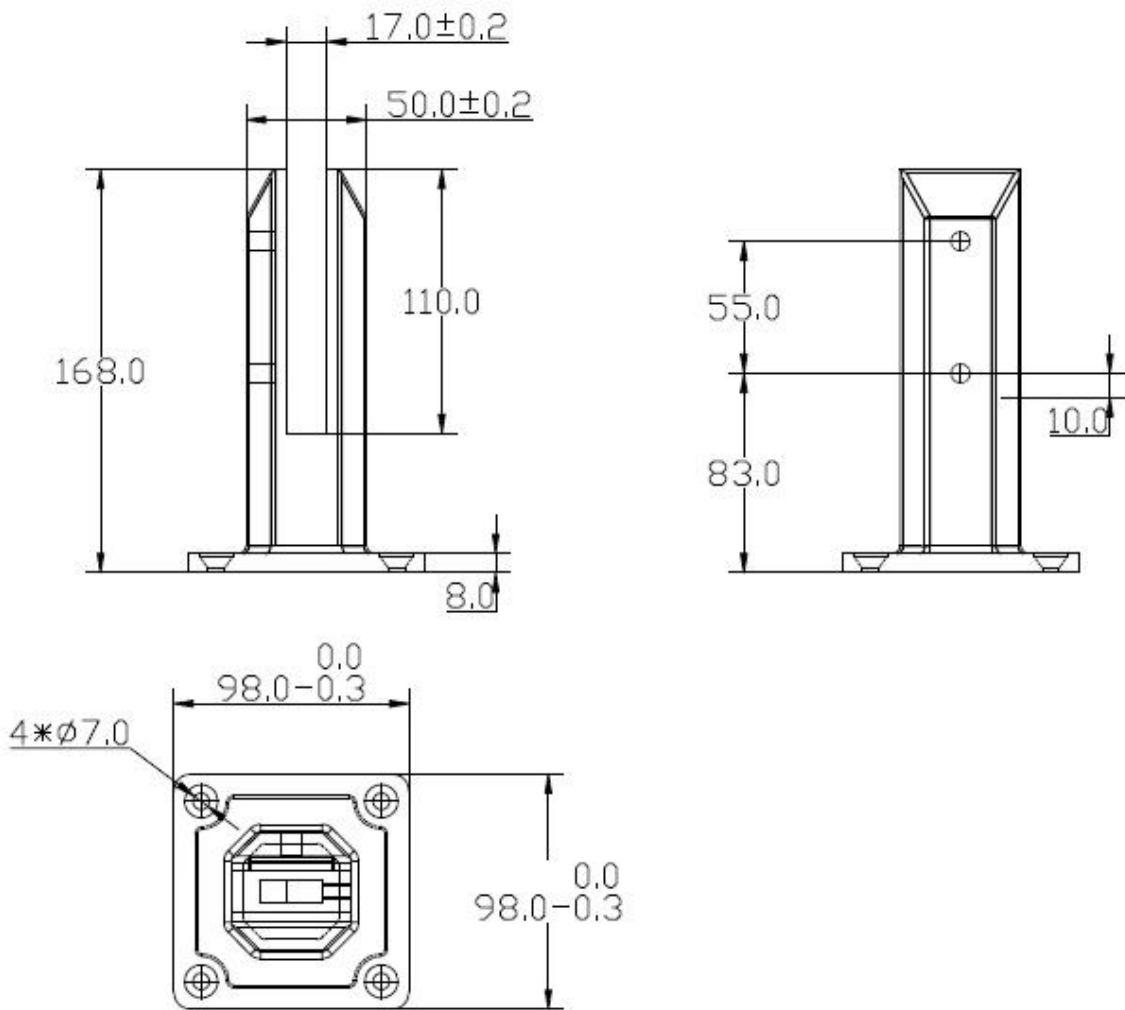





Drawing



Verpakking & levering

- Een pc in een plastic zak, dan in een doos. 20 stuks in een doos.
- Verzendkosten optie: door (10-15 dagen) /by zeelucht (3-5 dagen)



packing	plastic bag+box+carton
production lead time	30-45 days ; also depending on your qty.
Shippment	 
	 
	 
payment	 

Factory & certficering



KEBIL 科比奥™

ISO
9001:2008
REGISTERED

 **Factory Audit**



www.launch-china.cn



ISO
9001:2008
REGISTERED



Shenzhen Launch Co.,Ltd



www.launch-china.cn

Moet een offerte of vragen hebt, laat een berichtje achter.

Of contact met mij zoals hieronder info. zullen binnenkort contact met u ASAP!

KEBIL 科比奥®

深圳市朗驰商贸有限公司
SHENZHEN LAUNCH CO., LTD.

朗驰国际有限公司
LAUNCH INTERNATIONAL LIMITED.

董 萍 Doris Dong

Senior Sales Representative

☎ (86) 135 3050 6265

深圳市南山区南山大道1092号亿利达大厦B区3栋5003

Room 5003, Building 3, Yilida Building, No.1092
Nanshan Road, Nanshan District, Shenzhen, China
postal code 518054

☎ (86-755) 8603 7559

☎ (86-755) 8637 2611

✉ sales04@launch-china.cn

🌐 www.launch-china.com

www.chinabalustrade.com