

Roestvrij staal vierkante Spider Baluster Post voor glazen balkon trap Deck reling ontwerpen



1. Specificaties van de Spider-postbaluster van roestvrij staal :

Artikel Naam	Roestvrij stalen vierkante spinbalustrade
Modelnr.	LCH-121
Materiaal	Roestvrij staal 304/316
Af hebben	Geborsteld of glanzend gepolijst
Vierkante berichtgrootte	Wanddikte van 50 x 50 x 1,5 mm Wanddikte van 40 x 40 x 1,5 mm
Hoogte	De klantgerichte
Voor glasdikte	10-15mm
Toepassing	Ontwerp met balkonbalustrades Veranda reling ontwerp Ontwerp van dekleuning Trapleuning ontwerp

Eindpaal met 1-weg spider fitting

Middelste relingpost met 2-wegs spinfitting

Standaardhoogte: 1100 mm (beschikbare klantenposthoogtes)

Ontworpen voor 10-15mm glas of vanaf uw vereiste

Verstelbare hoeken staan uit ontwerp voor trappenhuis of balkon enz.



2. RVS Vierkante Spider Post Maattekening Voor uw referentie:

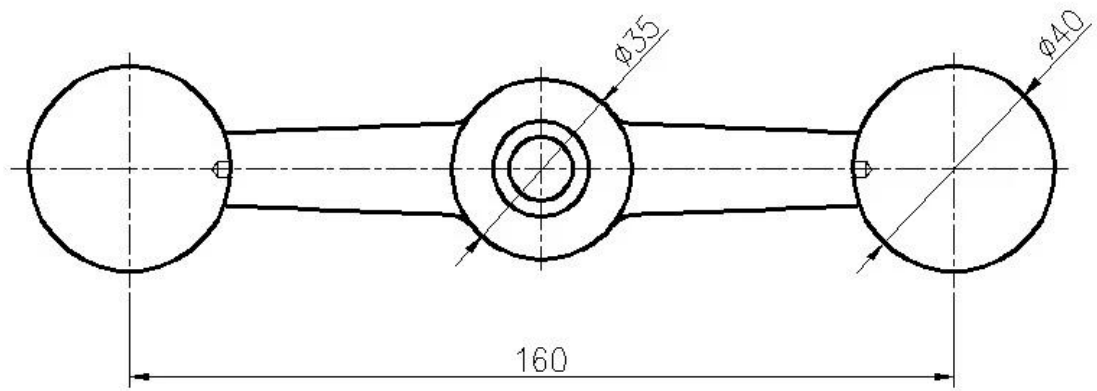
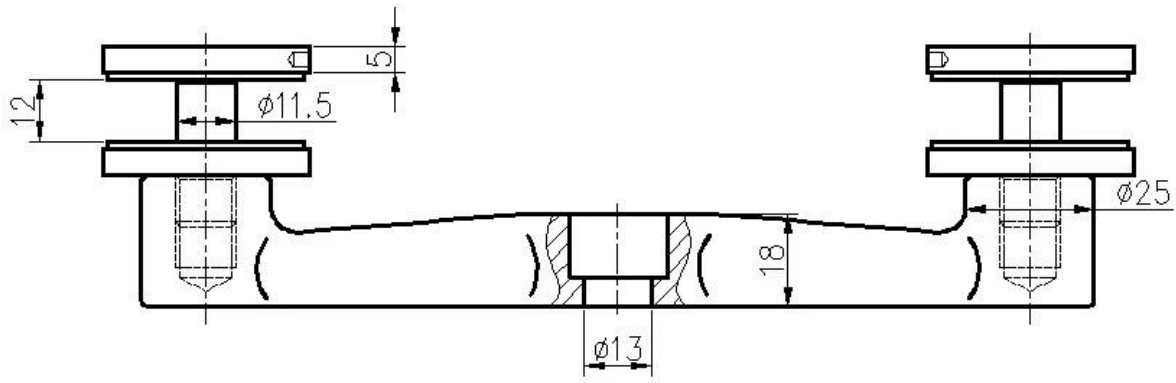

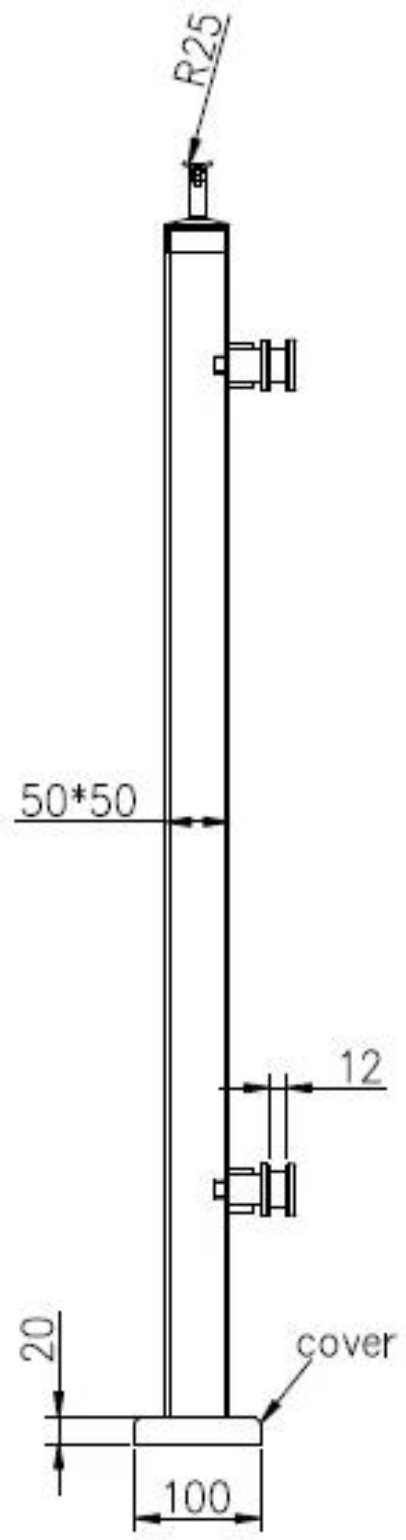
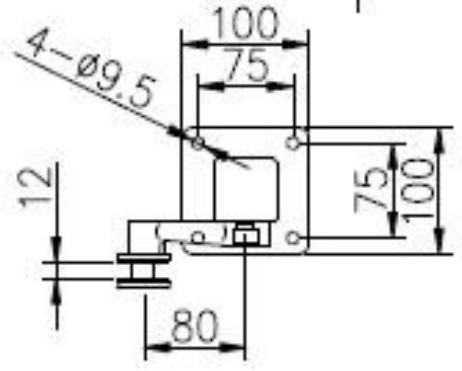
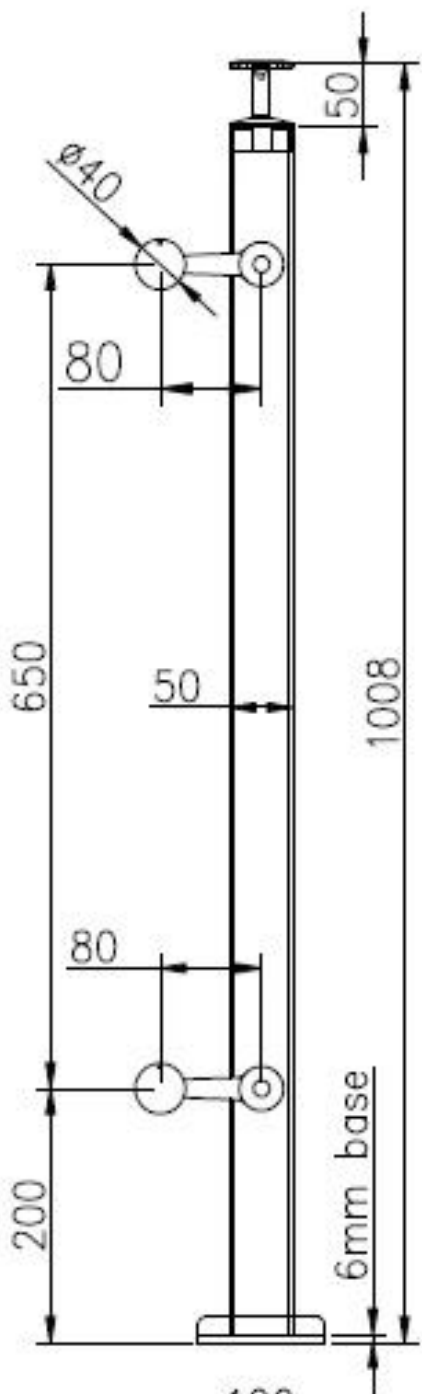

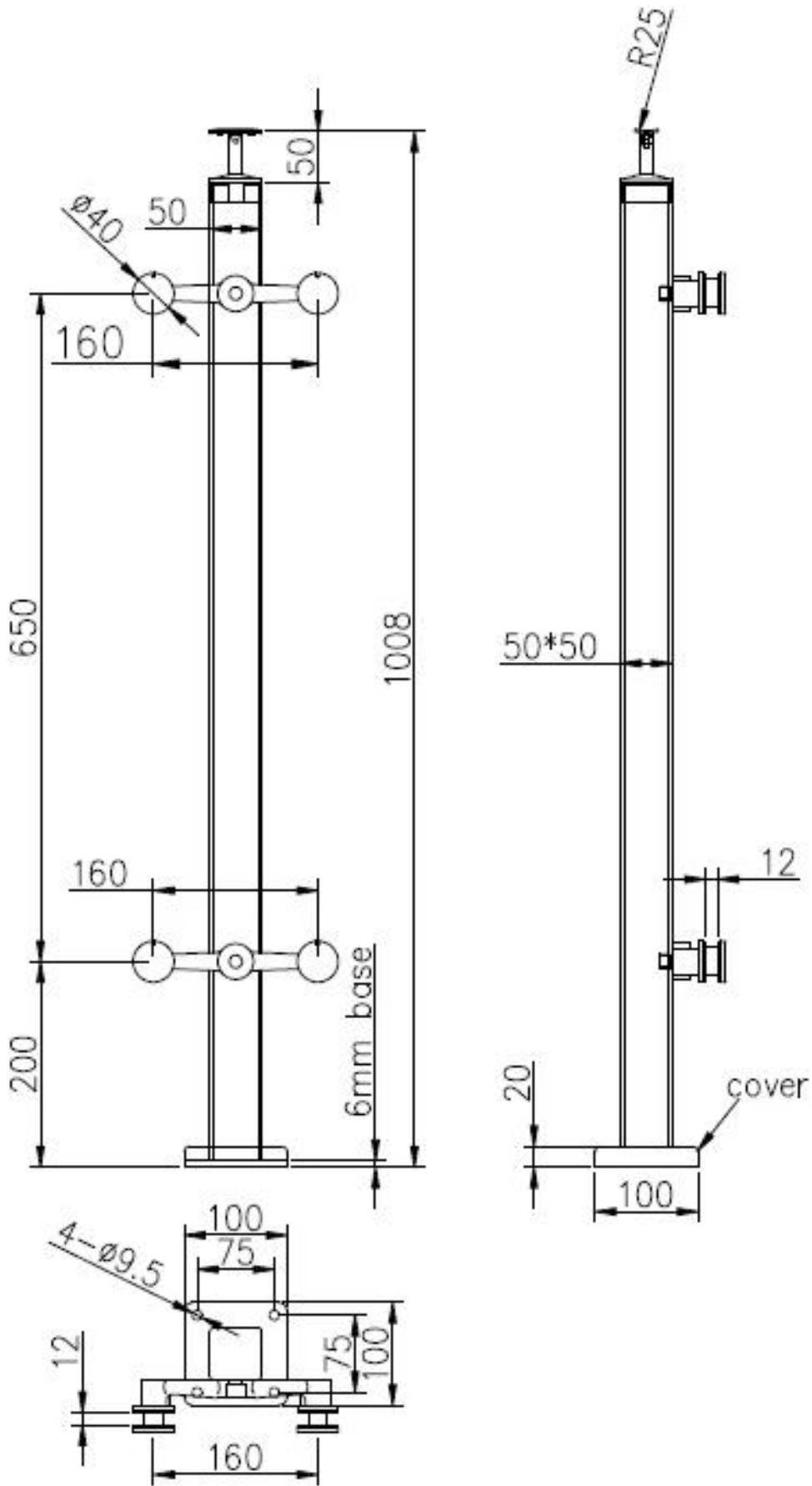

3. RVS Spider Baluster Postfoto's:

Bovenste verstelbare leuningbeugel voor vierkante of ronde buisleuning:



2-weg tussenliggend bericht:





1 Way End Post:



4. Verpakkingsfoto's: 1pc / plastic zak, 2 - 4pcs / ctn.





Bedrijf Informatie:

Shenzhen Launch Co., Ltd was established in 2004, located at Nanshan District, Shenzhen, and one hour by car from Hongkong International Airport. Our main product is high-grade building materials includes stainless steel balustrade post, staircase handrail, balcony guardrail, swimming pool fence and other high-grade building materials. All the products are designed strictly according to the high-end market requirements. We have our own factory in Tangxia Town, Dongguan, has a variety of precision equipment more than 50 sets: CNC lathe, milling machine, punching machine, pipe cutter, argon welder, drilling machine, polisher, etc. which can provide customers with complete product processing services. With the German SPECTRO Spectrometer, we insist on testing every batch of materials to ensure that the material is highly qualified. We also have hardness gauge, secondary element and other test equipment to ensure the products meets customers' requirements.

ABOUT US



OUR ADVANTAGE

Please do not hesitate to contact us if you have any requirement regarding our production lines, you can expect a timely reply with professional solutions!



Own factory, shortest lead time.



Can help customers design product drawings based on customer ideas and design engineering installation drawing according to the customer site sketch.



Sample order, trial order acceptable.



Provide material test report to ensure that the material is qualified.



13 years of industry experience, we can help customers recommend the best solution to help customers save cost.

OUR FACTORY

More than 13 years experience in hardware industry design and processing, we can provide customized services from design to the sample and small batch trial production.



OUR CERTIFICATE

With premium quality, competitive price and superior service, we won a lot of customers' favor.
Our products are popular in North America, European and Australia.



PRODUCTION PROCESS



Casting



CNC lathe



CNC Milling



Stamping



Drilling & Tapping



Polishing



PACKAGING & DELIVERY



PAYMENT & TRANSPORTATION

Welcome Alibaba Trade Assurance Order!

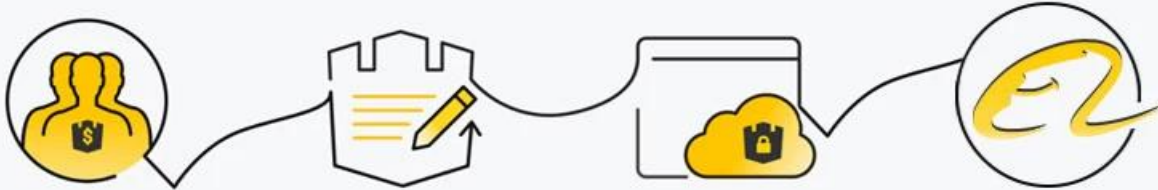

1 Start an order

2 Negotiate terms with our sales service & confirm order

3 Make payment

4 Alibaba provide full assurance



Neem vrijblijvend contact met ons op voor meer informatie:

E-mail: sales03@launch-china.cn

Contact: Eve Chow

WhatsApp / HP: +8615907334556