

Beschrijving

--RVS glas deur hinger G-W1 voor glas naar vierkante post of muur

--Model No.:G-w1

--Voor glas naar plein post/muur

--Vervaardiging methode: stempelen

--Kan houd ≤ 20 KG glas (glas 1000x1000x8mm)

--Plaatwerk dikte: 2.5mm

--Verpakking: een pc in een plastic zak, dan in een doos. 12 stuks in een doos.

--MOQ: één pc

--Levering: door de lucht/aan zee

--Toepassing: veilige zwembad omheining glazen deur, glazen reling, balcony design trapleuning, glazen [RVS vierkante post](#), glas te [aluminium vierkante post](#), glazen muur scharnier

--Voor zowel commercial en modern huis huisontwerp

--Voor zowel groothandel en retail (We zijn fabriek)

--Monster is altijd beschikbaar

Productdetails

Spiegel & sarin afwerking





G-W 1

Geboorde glas gat tekening

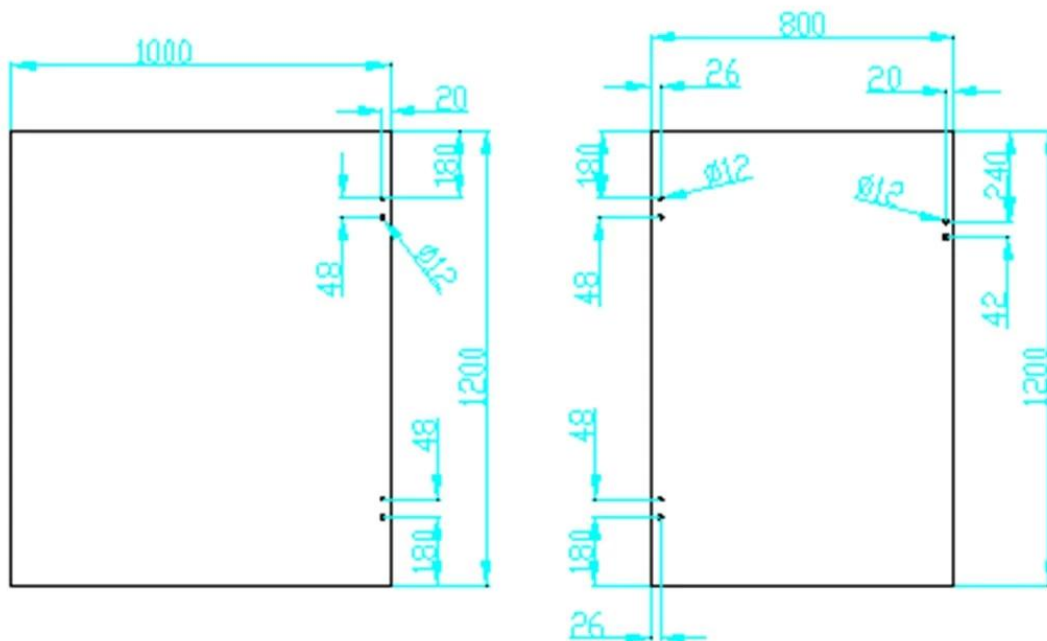









Glas scharnier komt meestal overeen met [glazen kraan](#) en [glazen naamplaten](#).

Ga voor meer beautiful zwembad omheining project foto's, [Hier](#)

Verpakking & levering

- Een pc in een plastic zak, dan in een doos.
- Reguliere levertijd: 10-15 dagen na betaling. Het is volgens hoeveelheid.
- Levertijd: 5-7 dagen door express. 15-20 dagen door de zee.

packing	plastic bag+box+carton
production lead time	30-45 days ; also depending on your qty.
Shippment	 
	   
payment	 



Factory & certificering





Wenst u een offerte of vragen? laat een berichtje achter.

Of contact met mij zoals hieronder info. zullen binnenkort contact met u ASAP!

KEBIL 科比奥

深圳市朗驰商贸有限公司
SHENZHEN LAUNCH CO., LTD.

朗驰国际有限公司
LAUNCH INTERNATIONAL LIMITED.

董萍 Doris Dong

Senior Sales Representative

☎ (86) 135 3050 6265

深圳市南山区南山大道1092号亿利达大厦B区3栋5003

Room 5003, Building 3, Yilida Building, No.1092 Nanshan Road, Nanshan District, Shenzhen, China postal code 518054

☎ (86-755) 8603 7559

☎ (86-755) 8637 2611

✉ sales04@launch-china.cn

🌐 www.launch-china.com

🌐 www.chinabalustrade.com

