

## Opis

- Wymiar: 50x50mm, 1265mm wysokiej lub zależnie od wymagań.
- Grubość ścianki aluminium post: 3mm
- Dla grubość szkła: 8-12mm
- 2 rodzaje aluminium post
  1. mocowania do betonu (1800mm, wysoka lub jak na swoje wymagania)
  2. z płyt bazowych (1265mm wysokiej lub jak na swoje wymagania)
- Aplikacji: basen ogrodzenia, balkon bezramowa poręcz, pokład szkło poręcz, ogrodzenia ogrodowe, aluminium balustrady systemowe, balustrady aluminiowe
- Dla zarówno komercyjnych, jak i nowoczesny dom projekt domu
- Dla zarówno handel hurtowy i detaliczny (jesteśmy fabryka)
- Próbki jest zawsze dostępne
- Zdały test wytrzymałości

## 4 rodzaje aluminium post

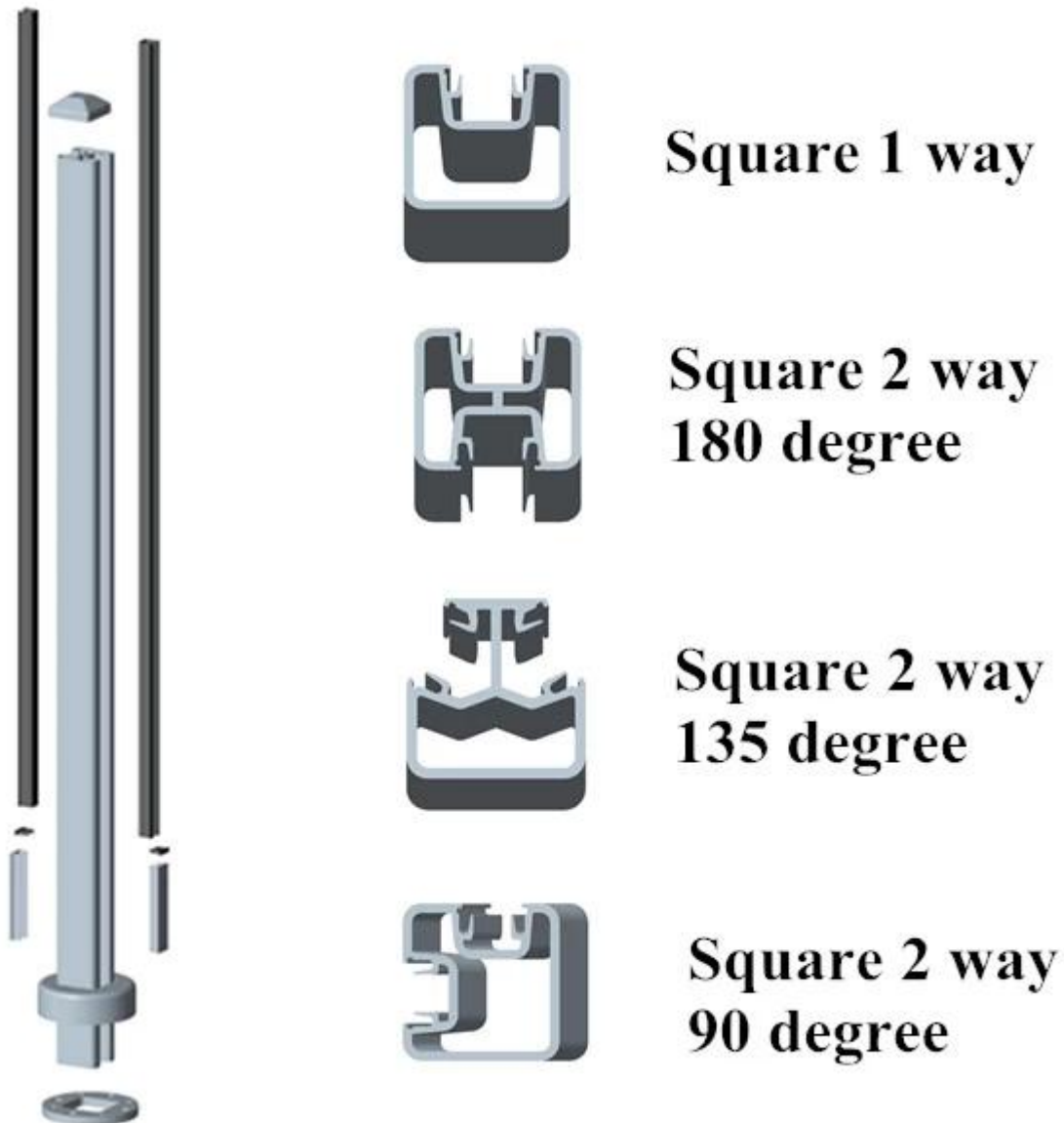



### Szczegóły

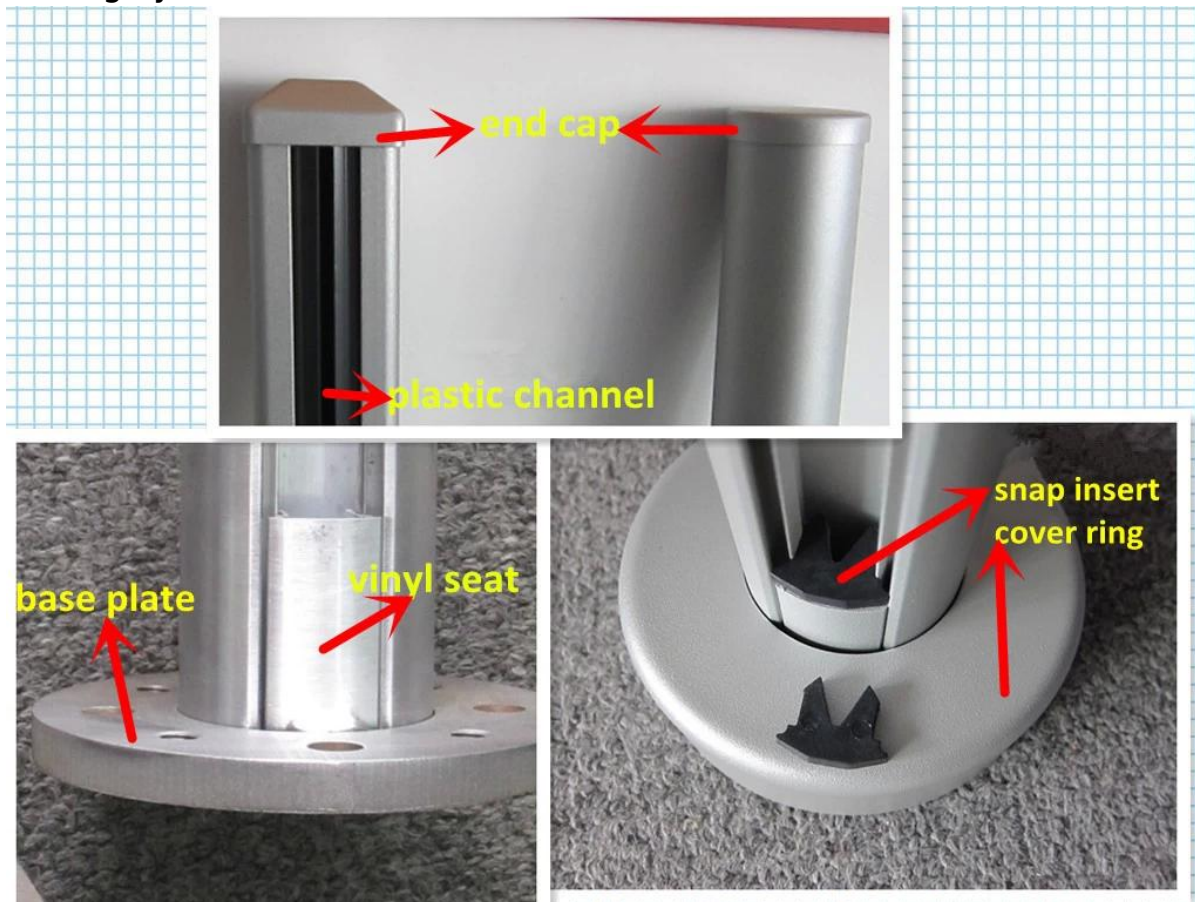





Wspornik montażowy po stronie



# Side mounting bracket

Zakończ

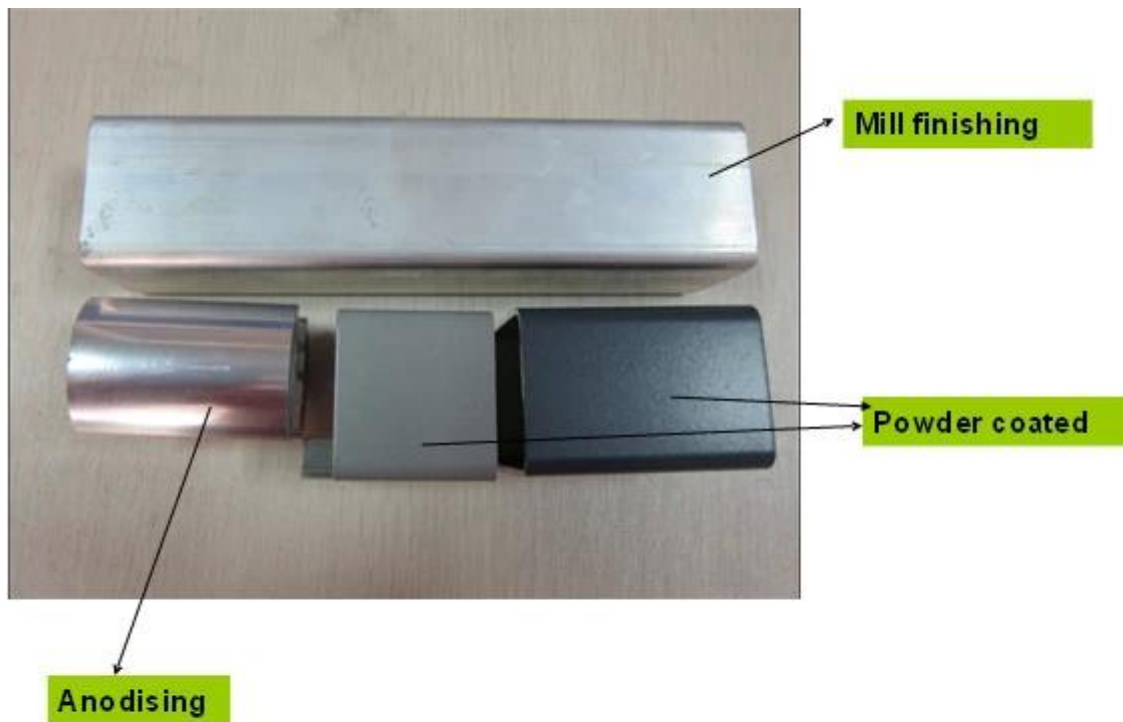

## Projekt

Aluminium post dla głupca, szermierka (zwykle używany z [Zawias](#) i [zatrzask](#) )





Połowie drogi post projektu



Balkon i balustrady aluminiowe pokładu



Fabryka i Certifacation











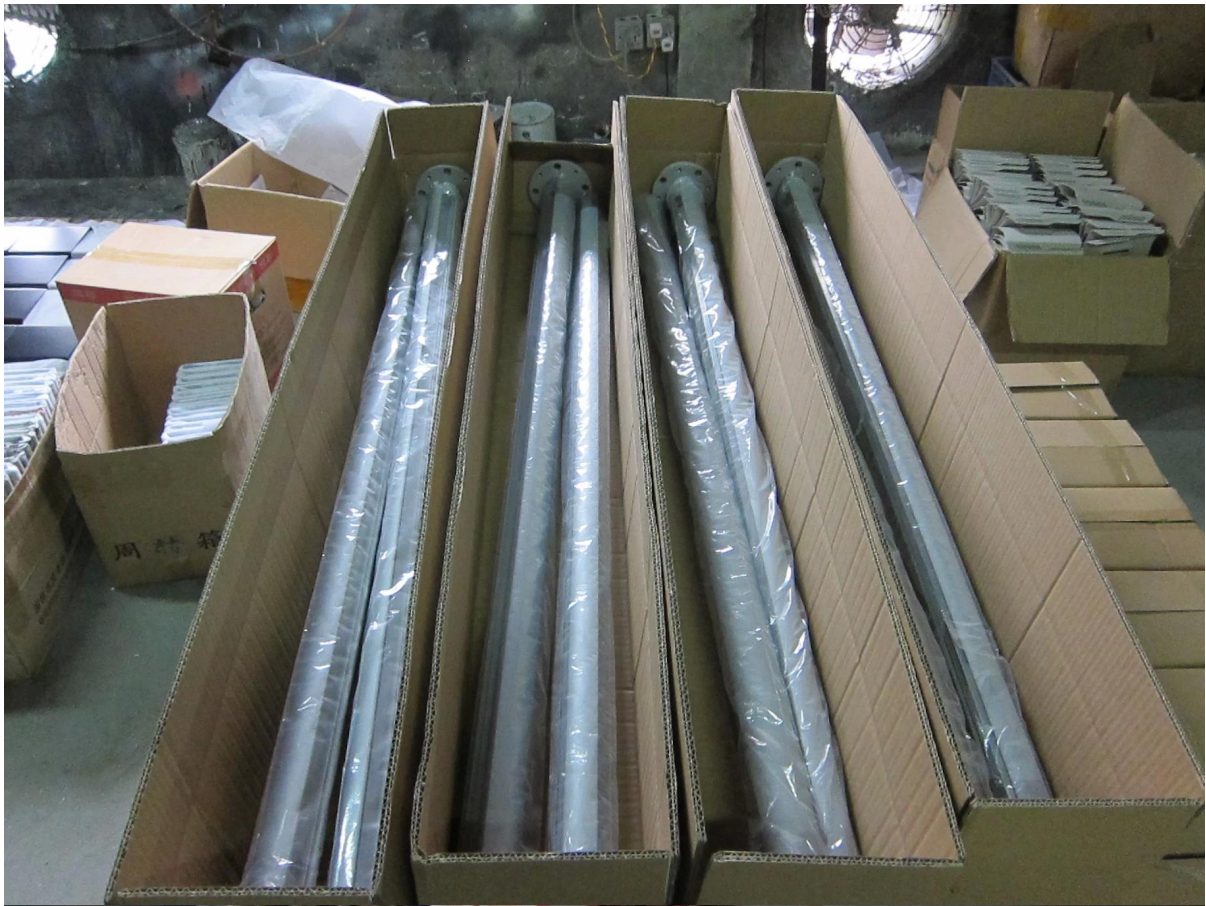



### Pakowanie i dostawa

- jeden pc do jednego worka z tworzywa sztucznego, a następnie w jednym pudełku.
- 3-5 dni dostawy przez express. 10-15 dni wysyłka drogą morską



packing	plastic bag+box+carton
production lead time	30-45 days ; also depending on your qty.
Shippment	 
	 
	 
payment	 

Klienci



### Why choose Launch--advantages

1. Various ranges of items for your selection
2. Provide professional services (3D & AUTOCAD)
3. Special designs by customer can be made
4. Competitive price with good discount
5. Superb quality control, production inspected one by one
6. Timely delivery, usually within a month
7. Good service before, during and after sales
8. OEM, ODM available

Dziękuję za odwiedzin!

Potrzebujesz Cytat lub jakiegokolwiek pytania, proszę zostawić wiadomość, będzie wracać do Ciebie jak najszybciej!

Lub skontaktuj się ze mną jak poniżej informacje.

KEBIL 科比奥®

深圳市朗驰商贸有限公司  
SHENZHEN LAUNCH CO., LTD.

朗驰国际有限公司  
LAUNCH INTERNATIONAL LIMITED.

**董萍** Doris Dong

Senior Sales Representative

☎ (86) 135 3050 6265

---

深圳市南山区南山大道1092号亿利达大厦B区3栋5003

Room 5003, Building 3, Yilida Building, No.1092  
Nanshan Road, Nanshan District, Shenzhen, China  
postal code 518054

---

☎ (86-755) 8603 7559

☎ (86-755) 8637 2611

✉ sales04@launch-china.cn

🌐 www.launch-china.com

www.chinabalustrade.com

Aby uzyskać bardziej fajna aluminiowa poręcz Zdjęcia przejdź [tutaj](#)