

Fabryczny profil aluminiowy kanał U, aluminiowy kanał szklany na taras balkonowy Pokład Systemy do projektowania balustrad metalowych



Specyfikacja aluminiowych balustrad szklanych:

| BALUSTRADY - PIWNICA | MATERIAŁ | WYMIAR (MM) | POWIERZCHNIA WYKOŃCZONA | GRUBOŚĆ SZKŁA PASOWANEGO (MM) |
|----------------------------|--------------------------|-------------|----------------------------|-------------------------------|
| Kanał U / Profil U | Aluminium Alloy | 102 * 62 | Farba anodowana / w sprayu | 12-13,52 |
| | | 102 * 67 | | 8 + 1,52 + 8 |
| | | 102 * 70,5 | | 10 + 1,52 + 10 |
| System wewnętrzny i rygiel | 3 lub 4 metry na długość | | | |

| | | | | |
|-----------|-------------------|-------|-----------------------|----------|
| Okładzina | SUS 304 / SUS 316 | 102 | Szczotkowany / Lustro | / |
| Gumowy | Plastikowy | Różny | czarny | Wszystko |



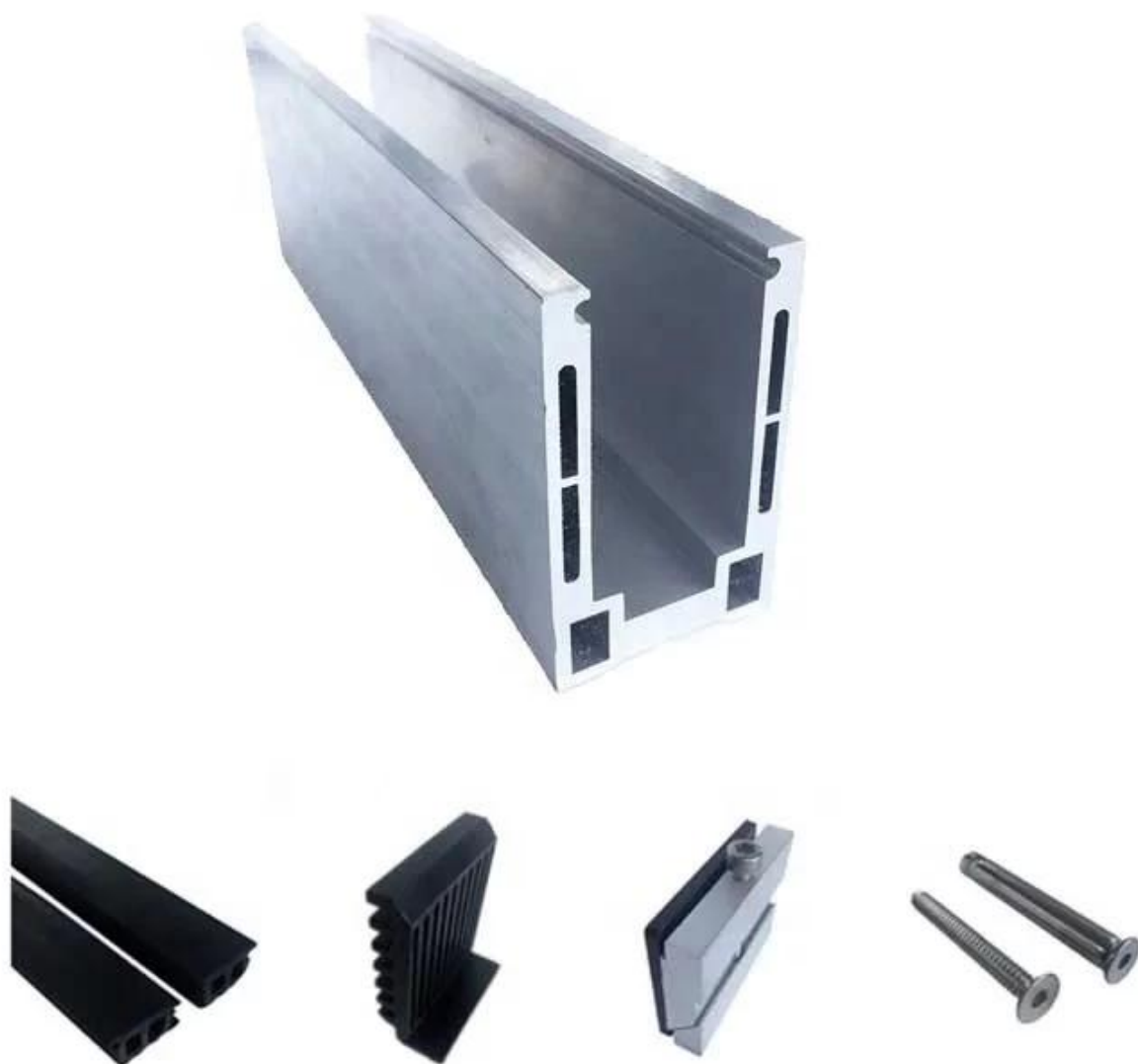

Aluminiowy profil podstawy U do balustrady szklanej w kolorze czarnym:



Dostępne modele:

LCH-A01 / A02: bez / z okładziną do stosowania ze szkłem 20 mm do 21,52 mm

LCH-A01



20 mm to 21.52 mm tempered glass

1 m aluminium groove contains the following accessories (excluding glass)



Aluminum trough 1 m Waterproof tape 2 meters Aluminum plastic fittings 3 sets Expansion screws 3 pieces

LCH-A02

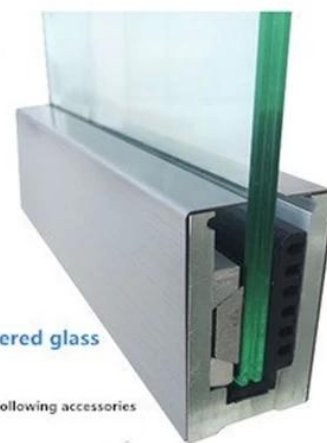

20 mm to 21.52 mm tempered glass

1 m aluminium groove contains the following accessories (excluding glass)

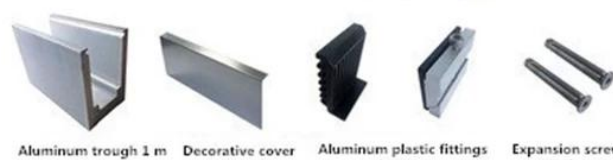

Aluminum trough 1 m Decorative cover 2 meters Aluminum plastic fittings 3 sets Expansion screws 3 pieces

LCH-B01 / A02: bez / z okładziną do użytku ze szkłem 16 mm do 17,52 mm

LCH-B01

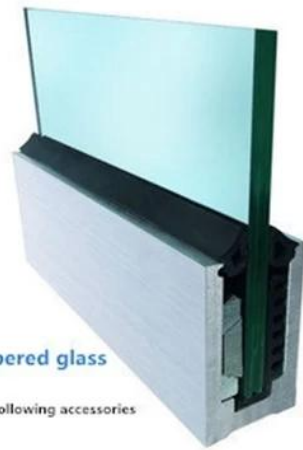

16 mm to 17.52 mm tempered glass

1 m aluminium groove contains the following accessories (excluding glass)



LCH-B02



16 mm to 17.52 mm tempered glass

1 m aluminium groove contains the following accessories (excluding glass)



LCH-C01 / A02: bez / z okładziną do użytku ze szkłem 12 mm do 13,14 mm

LCH-C01



12 mm to 13.14 mm tempered glass

1 m aluminium groove contains the following accessories (excluding glass)



LCH-C02



12 mm to 13.14 mm tempered glass

1 m aluminium groove contains the following accessories (excluding glass)

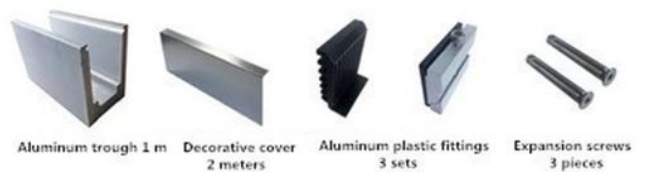

LCH-D01 / A02: bez / z okładziną do użytku ze szkłem 12 mm do 13,14 mm

LCH-D01



12 mm to 13.14 mm tempered glass

1 m aluminium groove contains the following accessories (excluding glass)



Aluminum trough 1 m



Waterproof tape 2 meters



Aluminum plastic fittings 3 sets



Expansion screws 3 pieces

LCH-D02



12 mm to 13.14 mm tempered glass

1 m aluminium groove contains the following accessories (excluding glass)



Aluminum trough 1 m



Decorative cover 2 meters



Aluminum plastic fittings 3 sets



Expansion screws 3 pieces

Do zastosowań komercyjnych i mieszkaniowych, nplub zarówno hurtowo, jak i detalicznie (jesteśmy producentem)
Poniżej kilka zdjęć z Projektu:







WIĘCEJ RODZAJÓW KANAŁU ALUMINIOWEGO U DO BALUSTRADY SZKLANEJ:

Small profile: for glass thickness 10-12.76mm

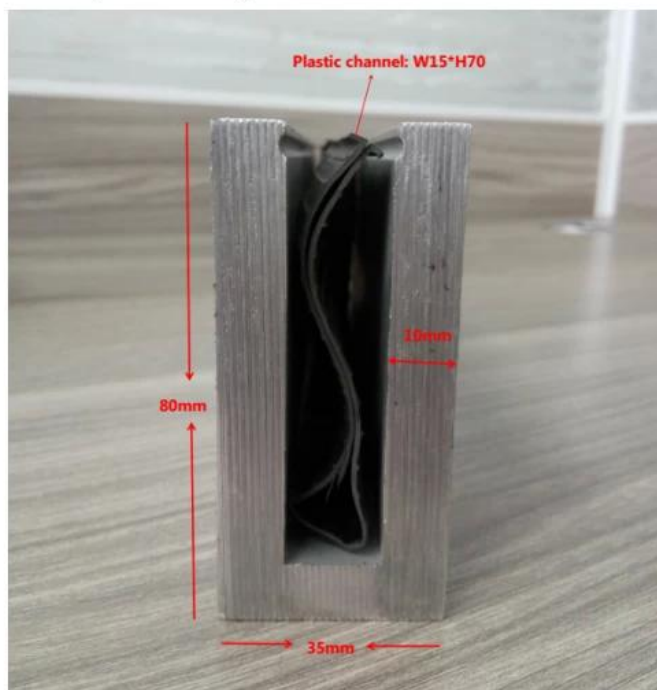

Big profile: for glass thickness 20-30mm

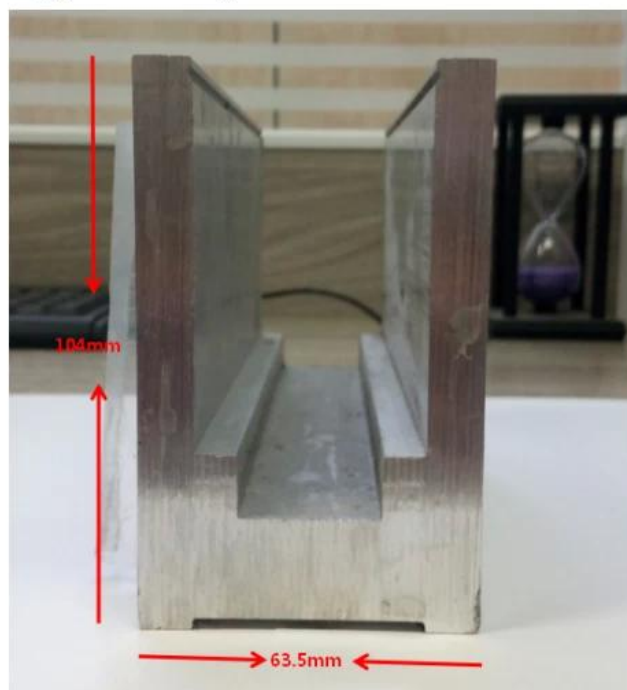

Produkty powiązane:

- poręcz z rurki szczelinowej.

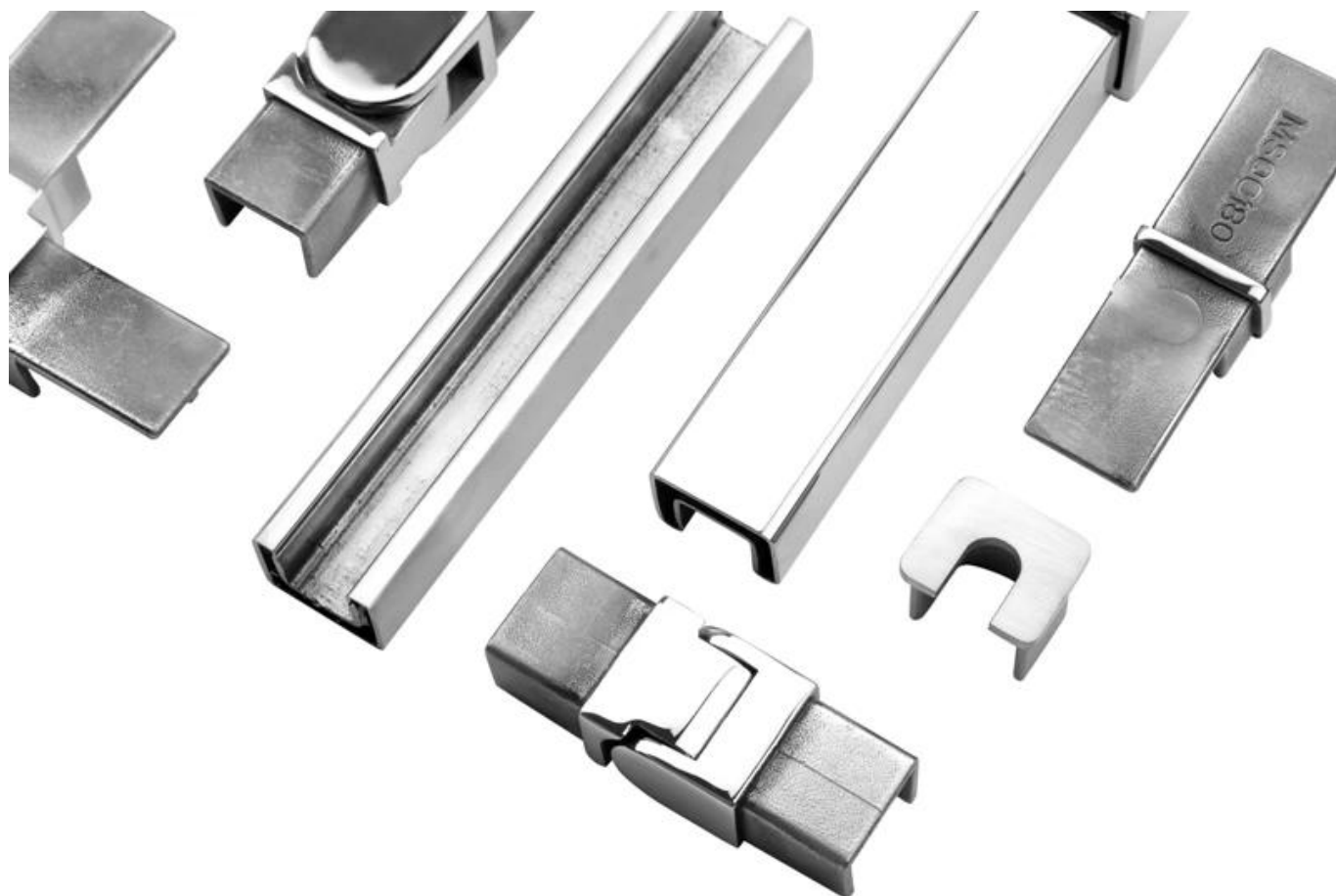



Skontaktuj się z nami aby uzyskać więcej informacji:

Wendy: sales04@launch-china.cn

Mobile / Whatsapp: + 86159 8933 9827