

Opis

- Kwadratowych rdzeń wiertła czop stali nierdzewnej basen bezpieczeństwa ogrodzenia
- Materiał: stal nierdzewna 316, 316L, duplex2205
- Instalacja: mocowania do betonu
- Do szkła o grubości: 10-13. 52 mm (oferujemy również czop szkło do szkła 15-16 mm)
- Aby pomieścić 1500mm szeroki szkło
- Aplikacji: bezpieczne krystalicznie czysty basen ogrodzenia, bezramowe balustrady balkonu, pokładu szkło poręczce, stal nierdzewna ogród ogrodzenia, podwórku stali nierdzewnej poręczce, balustrady szklane
- Dla zarówno komercyjnych, jak i nowoczesny dom projekt domu
- Dla zarówno handel hurtowy i detaliczny (jesteśmy fabryka)
- Próbki jest zawsze dostępne
- Zdały test wytrzymałości

Dane produktów
powierzchni lustra



Powierzchnia satyna



Zdjęcia projektu



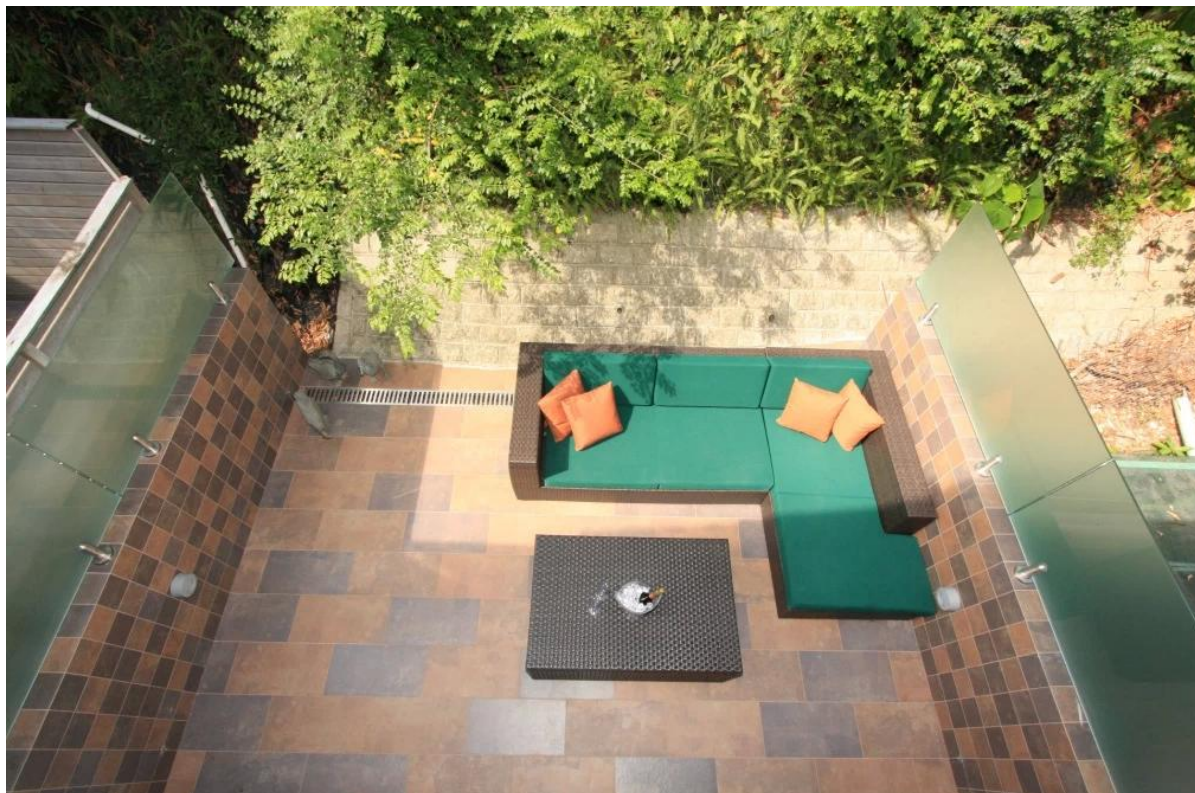

Powiązane produkty: [szkło zatrask](#), [Zawias drzwi szklane](#), [Gniazdo poręczy tube](#)

Aby uzyskać więcej inspiacji balustrady szklane przejdź [TUTAJ](#)

Raport z badań wytrzymałości

Results Summary

(For details of individual tests, refer to the tables on the following pages.)

ID	Item/Heat No.	Dimensions/Type/Details	Finish	Overall Assessment
14117/01	SSBM316	180mm High, 50mm Square, Base Plate 316 Stainless steel	316L	COMPLIES

Remarks

After completion of the testing, the spigot was found to be in sound condition with no breakage, tearing or signs of fracture and no looseness of the fixings.

Colin Lorrimar
Metallurgical Testing Manager



Accreditation No. 
Accredited for compliance
with ISO/IEC 17025

Drawing

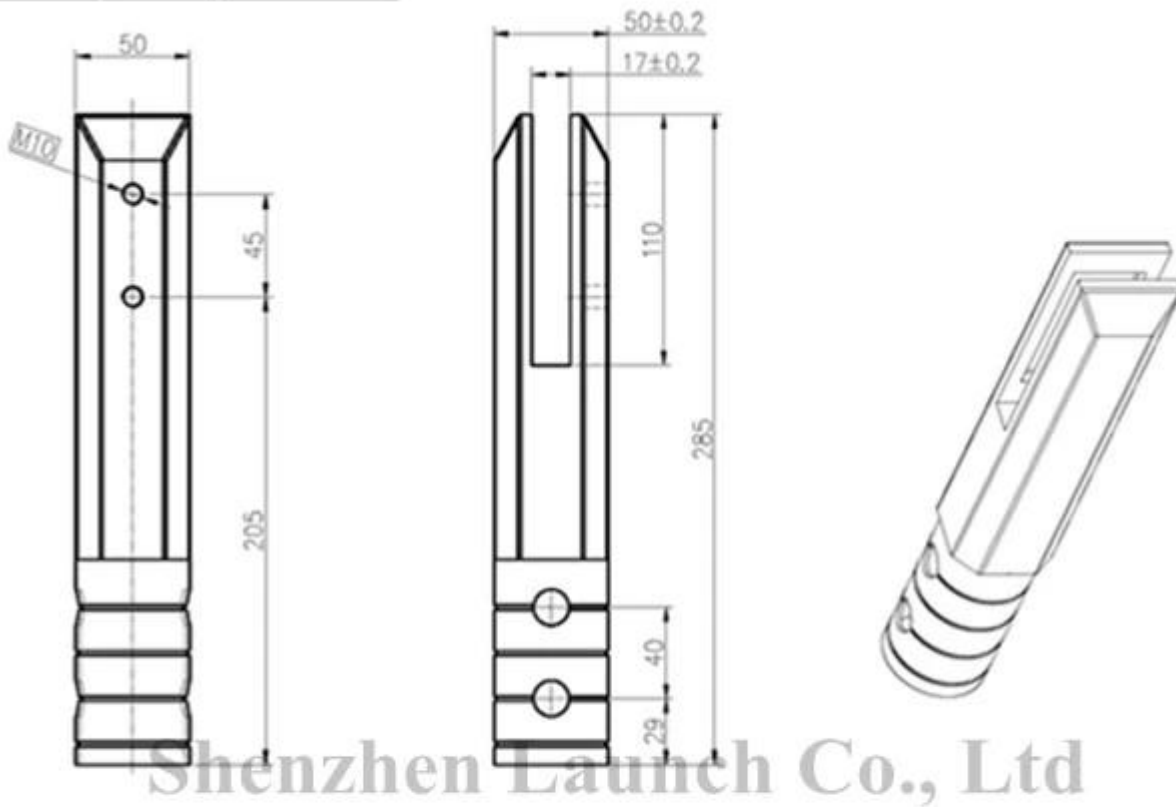

Shenzhen Launch Co., Ltd

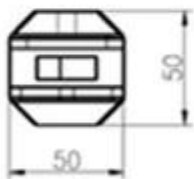

数量共页第页









深圳市朝福商贸有限公司		SHENZHEN LAUNCH CO., LTD.		表面处理
设计	裴佳辉	图号:SCM	名称:Spigot	材料
校对				未
工艺				线性公差
审核				角度公差
批准				
			版次	
			Y001	

Pakowanie i dostawa

--Jeden pc do jednego worka z tworzywa sztucznego, a następnie w jednym pudełku. 20 sztuk w jednym opakowaniu.

--Opcja wysyłki: samolotem/przez morza (10-15 dni) (3-5 dni)



packing	plastic bag+box+carton
production lead time	30-45 days ; also depending on your qty.
Shippment	 
	 
	 
payment	 

Fabryka i certyfikacja



KEBIL 科比奥™

ISO
9001:2008
REGISTERED

 **Factory Audit**



www.launch-china.cn



ISO
9001:2008
REGISTERED



Shenzhen Launch Co.,Ltd



www.launch-china.cn

Potrzebujesz Cytat lub jakiegokolwiek pytania, proszę zostawić wiadomość.

Lub skontaktuj się ze mną jak poniżej informacje. Skontaktujemy się z Tobą jak najszybciej!

KEBIL 科比奥®

深圳市朗驰商贸有限公司
SHENZHEN LAUNCH CO., LTD.

朗驰国际有限公司
LAUNCH INTERNATIONAL LIMITED.

董 萍 Doris Dong

Senior Sales Representative

☎ (86) 135 3050 6265

深圳市南山区南山大道1092号亿利达大厦B区3栋5003

Room 5003, Building 3, Yilida Building, No.1092
Nanshan Road, Nanshan District, Shenzhen, China
postal code 518054

☎ (86-755) 8603 7559

☎ (86-755) 8637 2611

✉ sales04@launch-china.cn

🌐 www.launch-china.com

www.chinabalustrade.com