

Szklany pajak ze stali nierdzewnej montażu szklanej baldachim montażu szklanej balustrady pajak montażu





1. Dane techniczne słupków ze słupka ze stali nierdzewnej :

Produkt Imię	Stal nierdzewna Square Spider Post Baluster
Model nr.	LCH-121
Materiał	Stal nierdzewna 304/316
koniec	Szczotkowane lub polerowane na lustro
Kwadratowy rozmiar postu	Grubość ściany 50 x 50 x 1,5 mm Grubość ścianki 40 x 40 x 1,5 mm
Wysokość	Konfigurowalny
Do grubości szkła	10-15 mm
Podanie	Balustrada balkonowa Poręcz balustrada Konstrukcja poręczy pokładu Konstrukcja balustrady schodowej



2. Rysunki wymiarów postów ze stali nierdzewnej Square Pająk dla odniesienia:

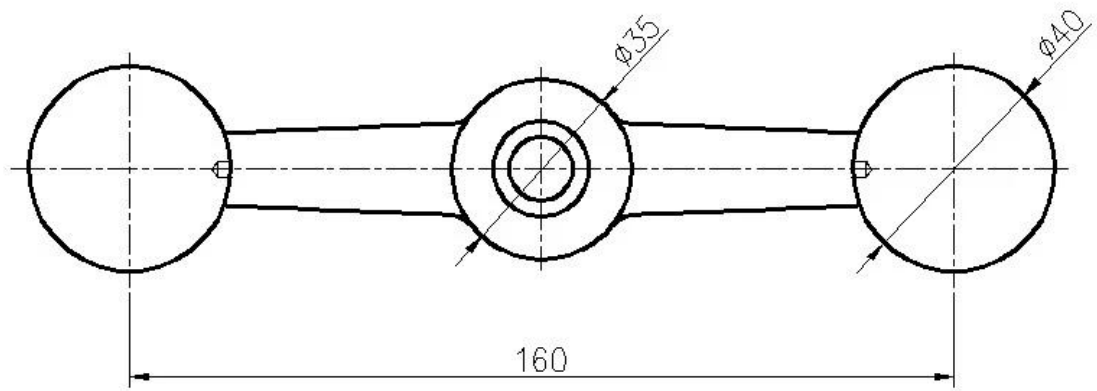
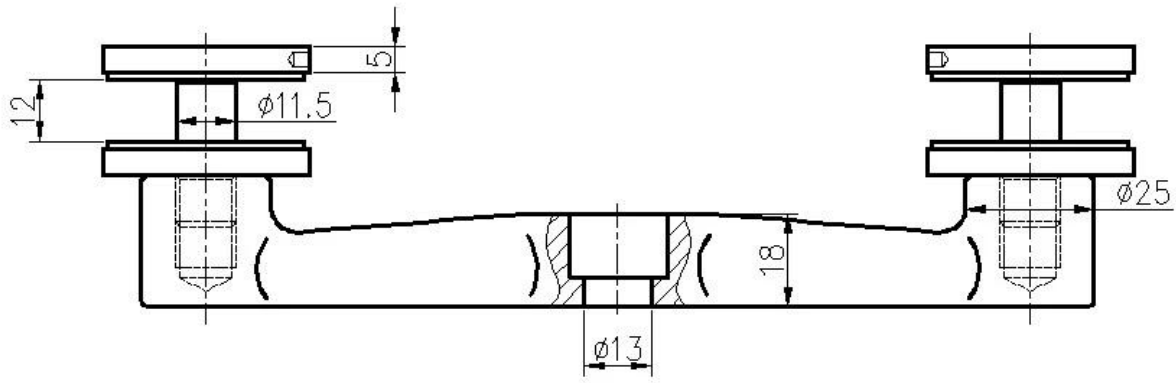

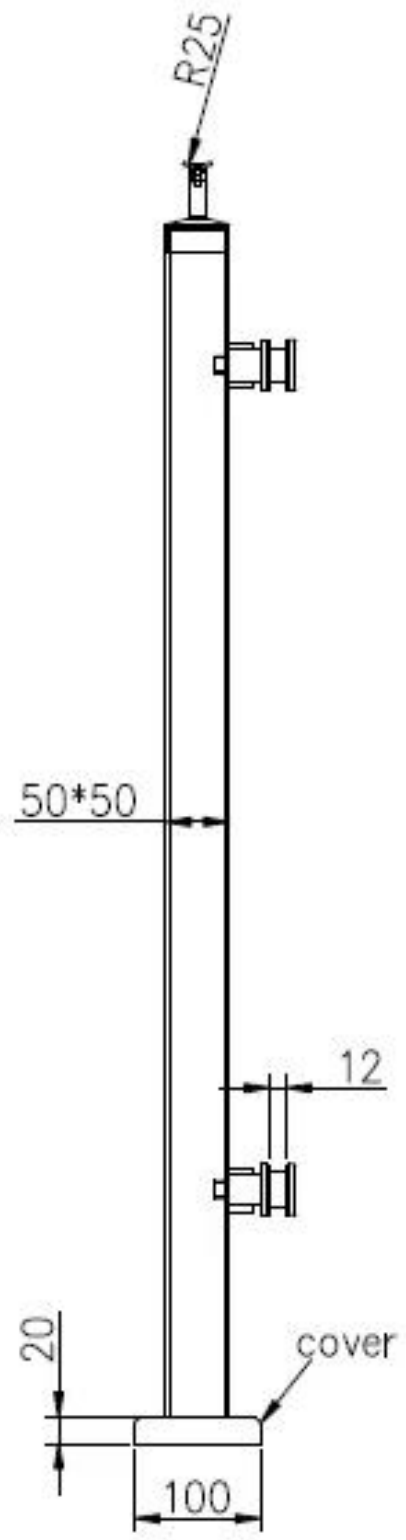
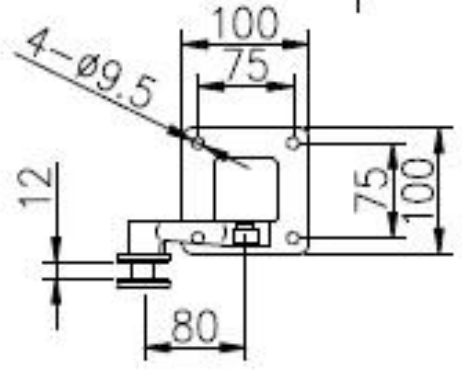
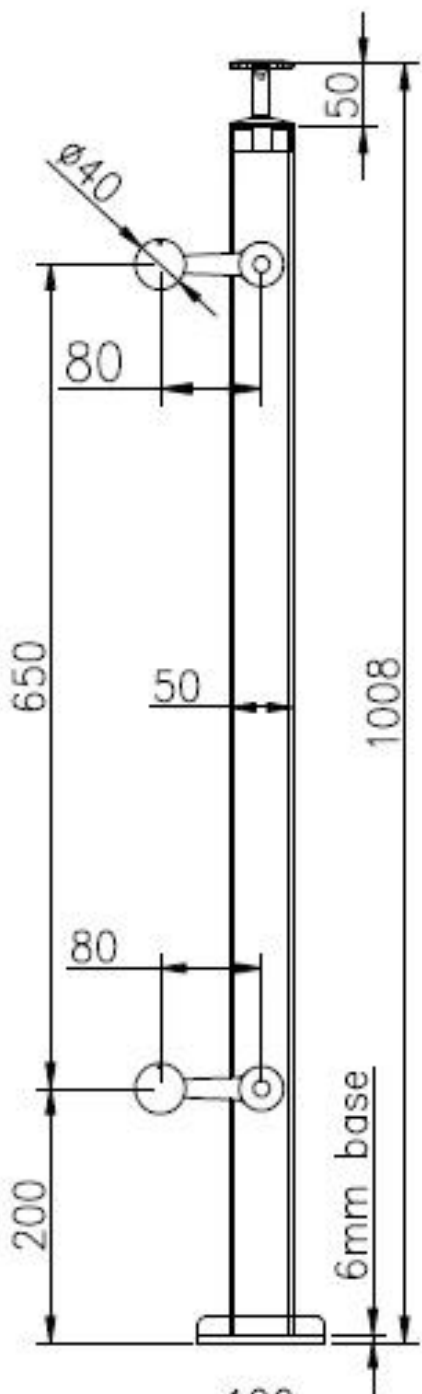

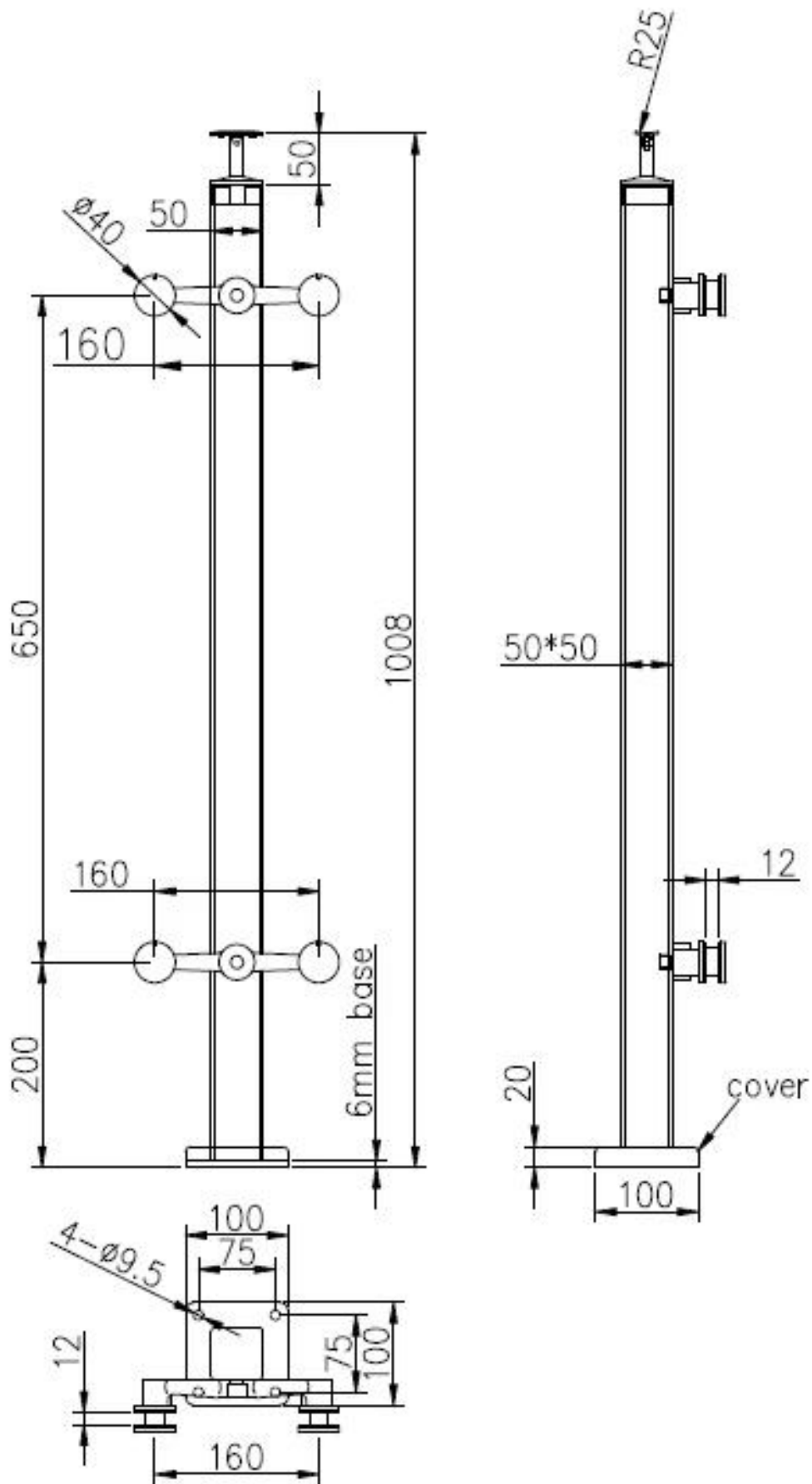

3. Pająk ze stali nierdzewnej Pająk Zdjęcia:

Górny regulowany wspornik poręczy do poręczy kwadratowych lub

okrągłych:



2 Way Intermediate Post:





1 Way End Post:



4. Pakowanie zdjęć: 1 szt. / Plastikowa torba, 2 - 4szt / szt.





Inne typy łączników typu Spider:

- łącznik krzyżakowy ze stali nierdzewnej do ściany osłonowej



- Okucie Spider OEM do szklanych systemów balustrad

KEBIL 科比奥®



Firma Informacja:

Shenzhen Launch Co., Ltd was established in 2004, located at Nanshan District, Shenzhen, and one hour by car from Hongkong International Airport. Our main product is high-grade building materials includes stainless steel balustrade post, staircase handrail, balcony guardrail, swimming pool fence and other high-grade building materials. All the products are designed strictly according to the high-end market requirements. We have our own factory in Tangxia Town, Dongguan, has a variety of precision equipment more than 50 sets: CNC lathe, milling machine, punching machine, pipe cutter, argon welder, drilling machine, polisher, etc. which can provide customers with complete product processing services. With the German SPECTRO Spectrometer, we insist on testing every batch of materials to ensure that the material is highly qualified. We also have hardness gauge, secondary element and other test equipment to ensure the products meets customers' requirements.

ABOUT US



OUR ADVANTAGE

Please do not hesitate to contact us if you have any requirement regarding our production lines, you can expect a timely reply with professional solutions!



Own factory, shortest lead time.



Can help customers design product drawings based on customer ideas and design engineering installation drawing according to the customer site sketch.



Sample order, trial order acceptable.



Provide material test report to ensure that the material is qualified.



13 years of industry experience, we can help customers recommend the best solution to help customers save cost.

OUR FACTORY

More than 13 years experience in hardware industry design and processing, we can provide customized services from design to the sample and small batch trial production.



OUR CERTIFICATE

With premium quality, competitive price and superior service, we won a lot of customers' favor.
Our products are popular in North America, European and Australia.



PRODUCTION PROCESS



Casting



CNC lathe



CNC Milling



Stamping



Drilling & Tapping



Polishing



PACKAGING & DELIVERY



PAYMENT & TRANSPORTATION

Welcome Alibaba Trade Assurance Order!

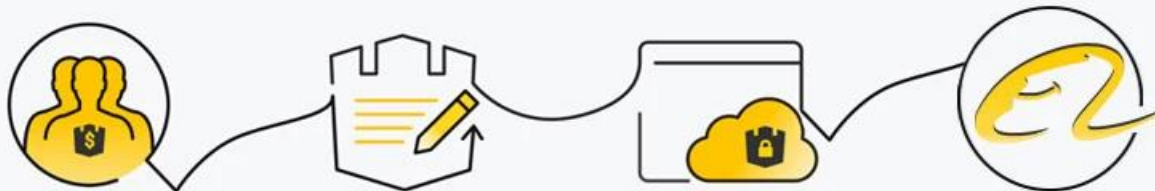

1 Start an order

2 Negotiate terms with our sales service & confirm order

3 Make payment

4 Alibaba provide full assurance



Skontaktuj się z nami swobodnie, aby uzyskać więcej informacji:

Email: sales03@launch-china.cn

Kontakt: Eve Chow

WhatsApp / HP: +8615907334556