

## Aluminium Security Balustrades Aluminum Metal Frameless Profile U Channel Clamp Glass Railing



### Aluminum Glass Railing specifications:

RAILING PART - BASEMENT	MATERIAL	DIMENSION(MM)	SURFACE FINISHED	SUITED GLASS THICKNESS (MM)
U Channel / U Profile	Aluminum Alloy	102*62	Anodizing / Spray Paint	12-13.52
		102*67		8+1.52+8
		102*70.5		10+1.52+10
Inside System & Bolt	3 or 4 meters per length			
Cladding	SUS 304 / SUS 316	102	Brushed / Mirror	/
Rubber	Plastic	Various	Black	All



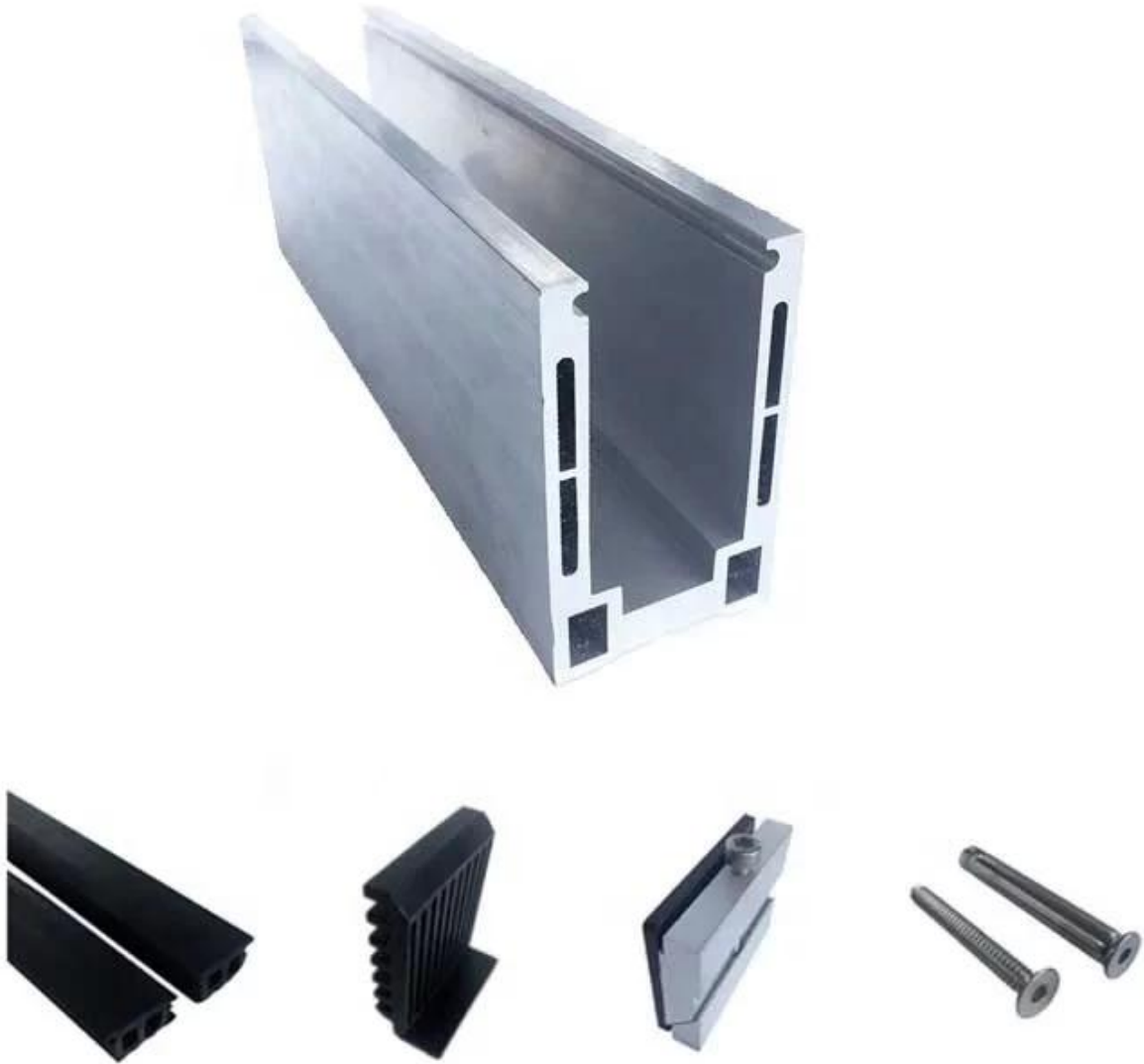

**Aluminum Base U Profile for Glass Railing in Black Color:**



**Available Models:**

LCH-A01/A02: without/with cladding for use with 20mm to 21.52mm glass

**LCH-A01**



20 mm to 21.52 mm tempered glass

1 m aluminium groove contains the following accessories (excluding glass)



Aluminum trough 1 m    Waterproof tape 2 meters    Aluminum plastic fittings 3 sets    Expansion screws 3 pieces

**LCH-A02**



20 mm to 21.52 mm tempered glass

1 m aluminium groove contains the following accessories (excluding glass)

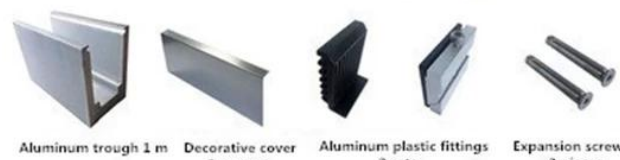

Aluminum trough 1 m    Decorative cover 2 meters    Aluminum plastic fittings 3 sets    Expansion screws 3 pieces

LCH-B01/A02: without/with cladding for use with 16mm to 17.52mm glass

**LCH-B01**



16 mm to 17.52 mm tempered glass

1 m aluminium groove contains the following accessories (excluding glass)



**LCH-B02**



16 mm to 17.52 mm tempered glass

1 m aluminium groove contains the following accessories (excluding glass)



**LCH-C01/A02: without/with cladding for use with 12mm to 13.14mm glass**

**LCH-C01**

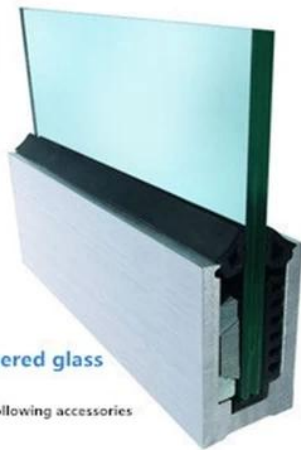

12 mm to 13.14 mm tempered glass

1 m aluminium groove contains the following accessories (excluding glass)

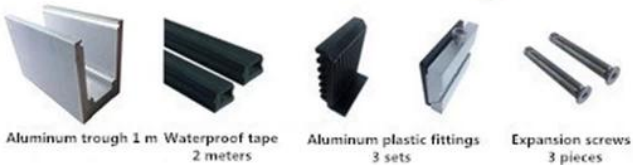

**LCH-C02**



12 mm to 13.14 mm tempered glass

1 m aluminium groove contains the following accessories (excluding glass)

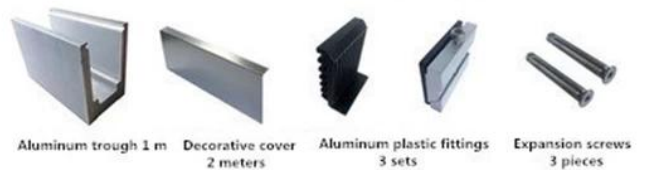

**LCH-D01/A02: without/with cladding for use with 12mm to 13.14mm glass**



LCH-D01



12 mm to 13.14 mm tempered glass

1 m aluminium groove contains the following accessories (excluding glass)



Aluminum trough 1 m



Waterproof tape 2 meters



Aluminum plastic fittings 3 sets



Expansion screws 3 pieces

LCH-D02



12 mm to 13.14 mm tempered glass

1 m aluminium groove contains the following accessories (excluding glass)



Aluminum trough 1 m



Decorative cover 2 meters



Aluminum plastic fittings 3 sets



Expansion screws 3 pieces

For both commercial and residential application  
For both wholesale and retail (We are manufacturer)













**MORE TYPES OF ALUMINIUM U CHANNEL FOR GLASS RAILING:**

Small profile: for glass thickness 10-12.76mm

Big profile: for glass thickness 20-30mm

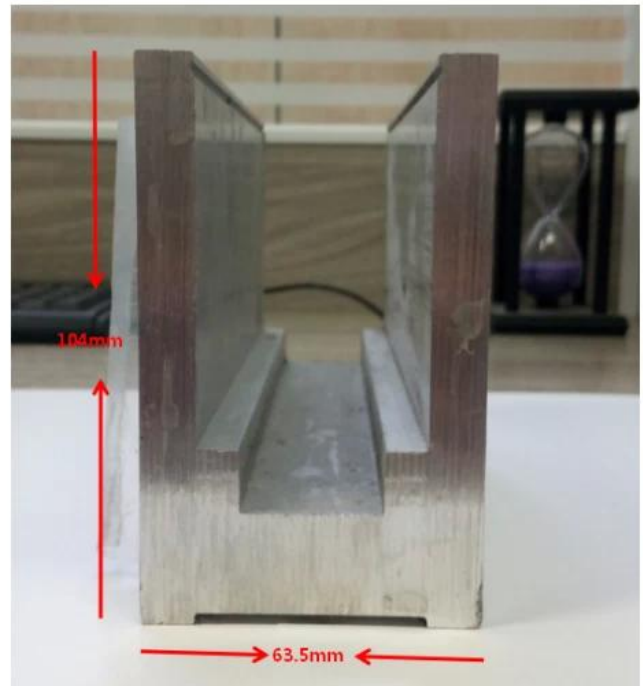
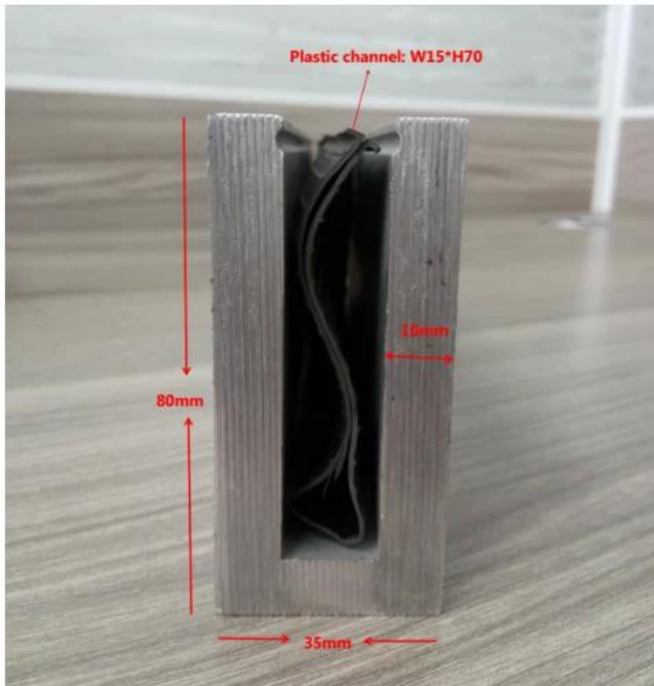

**SLOT TUBE HANDRAIL:**

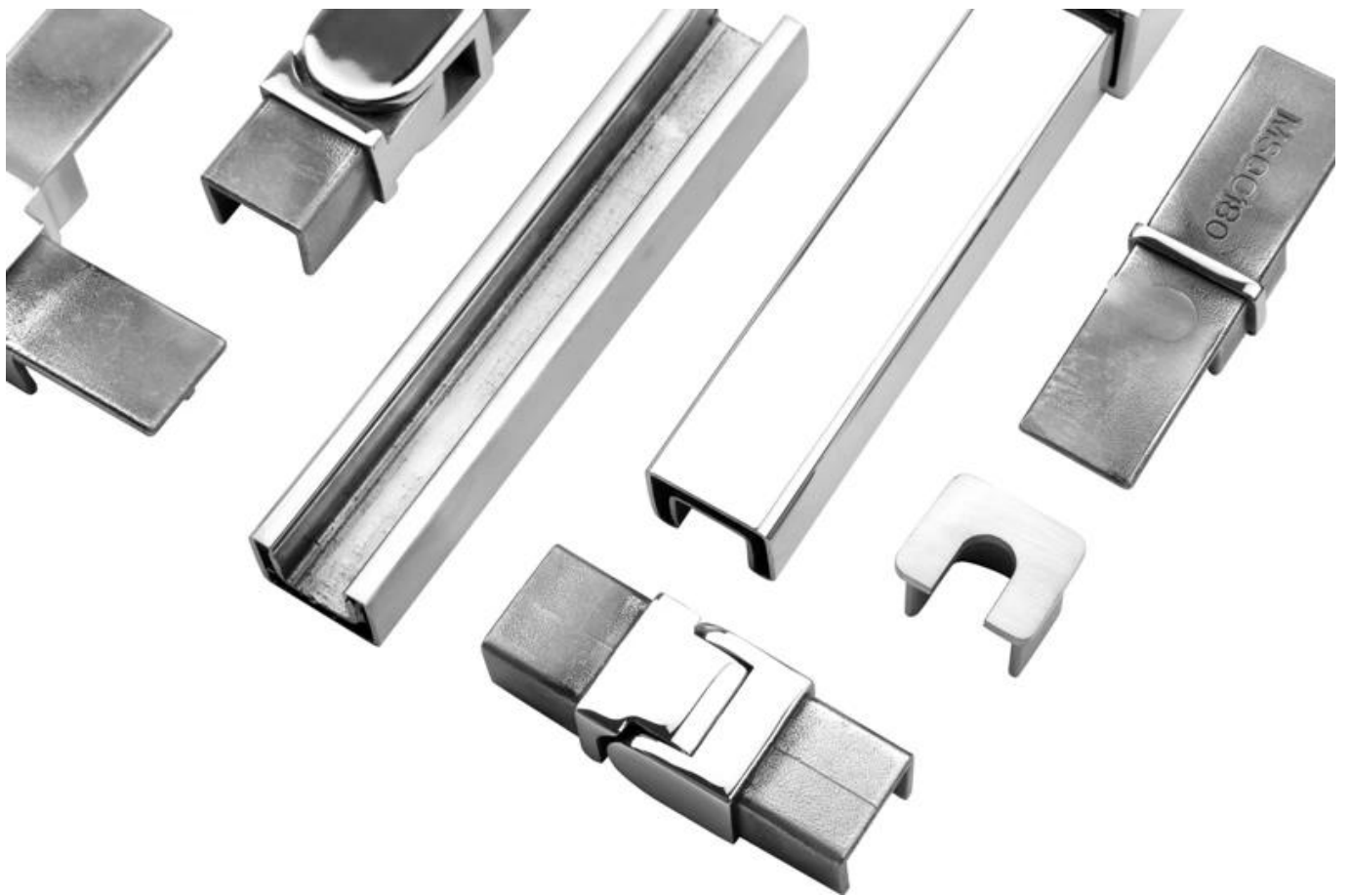



## FAQ

- 1. Are you factory?**  
Yes, we are factory.
- 2. Do you offer free samples?**  
Yes, we offer free samples, but customers need to pay express charges.
- 3. What materials do you have?**  
We have the material of stainless steel 304, 316, 316L and Duplex 2205.
- 4. What is your MOQ?**  
MOQ of order required is 1 pc.
- 5. What kind of payment do you accept?**  
We accept the payment of T/T, LC, PayPal, West Union, etc.
- 6. What is your payment term?**  
Our payment term is T/T(100% or 30/70)or LC at sight .
- 7. What is your delivery time?**  
Our delivery time is from 5days to 30days base on your quantity.
- 8. Do you offer OEM & ODM service?**



**Yes we offer OEM&ODM service.**

**9. Do you offer after-sales service?**

**Yes, we offer after-sales service. Any complaint for orders will be dealt with in time within 12 hours.**

**Contact us now for more information:**

**Eve**

**Email: [sales03@launch-china.cn](mailto:sales03@launch-china.cn)**

**Mobile / Whatsapp: +8613686807796**