

3 model gate latch

--Can hold $\leq 20\text{KG}$ glass (1000x1000x8mm glass)

--Glass to round post dia 50.8mm (Post drill hole size: dia 16mm)

G-G2 casting glass to glass hinge

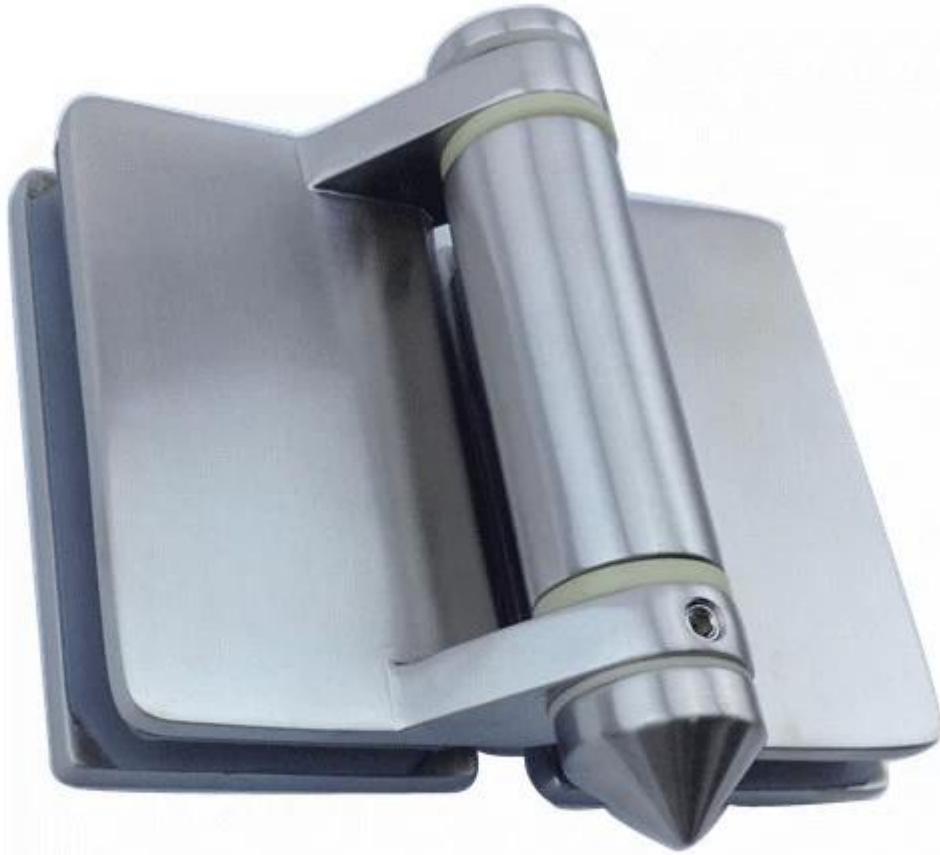

G-G2

G-R2 casting glass to round post hinge



G-R2

G-W2 casting glass to square post/wall hinge



G-W 2

Details

Mirror finish





Satin finish



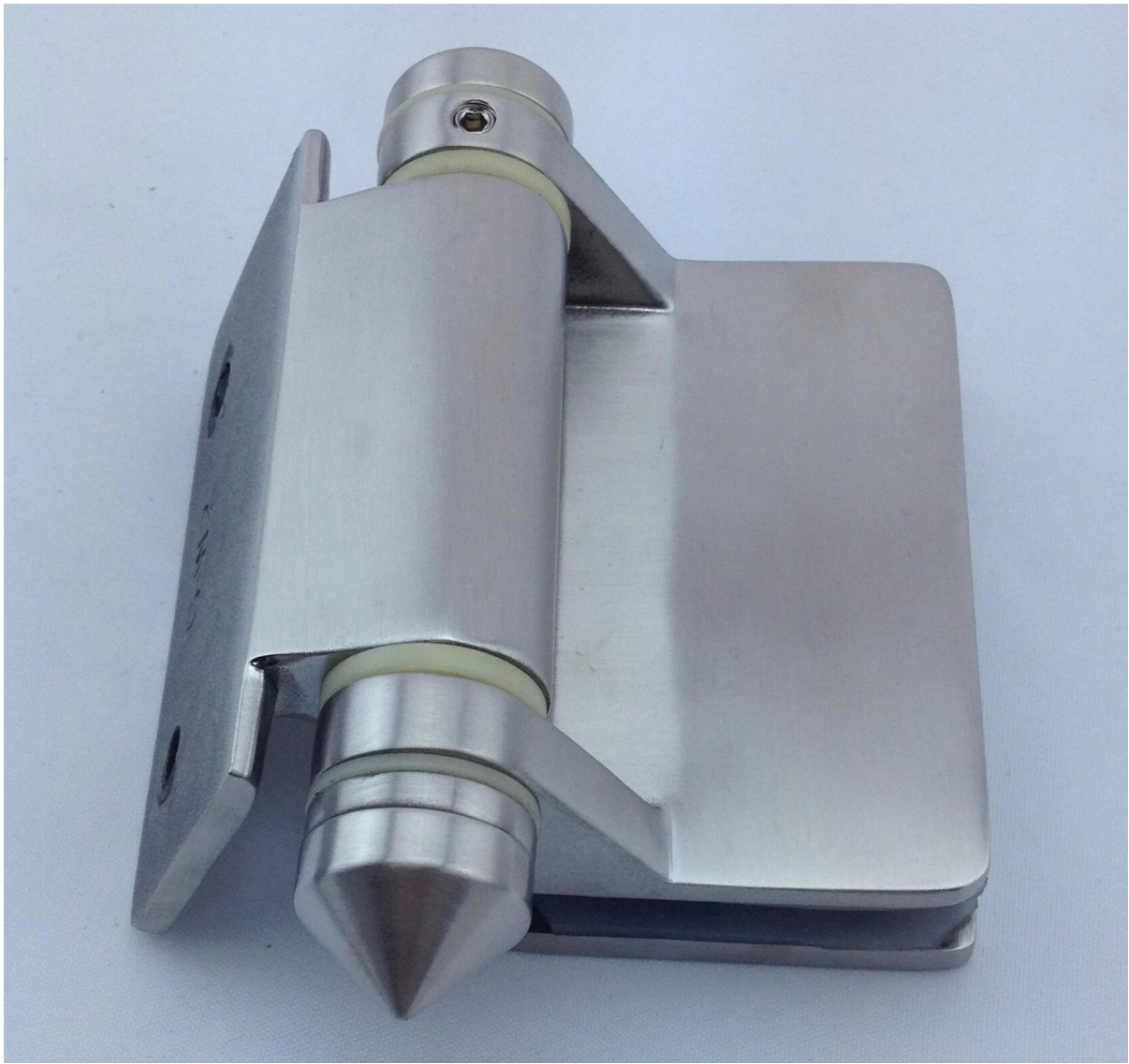



Drilled glass hole drawing

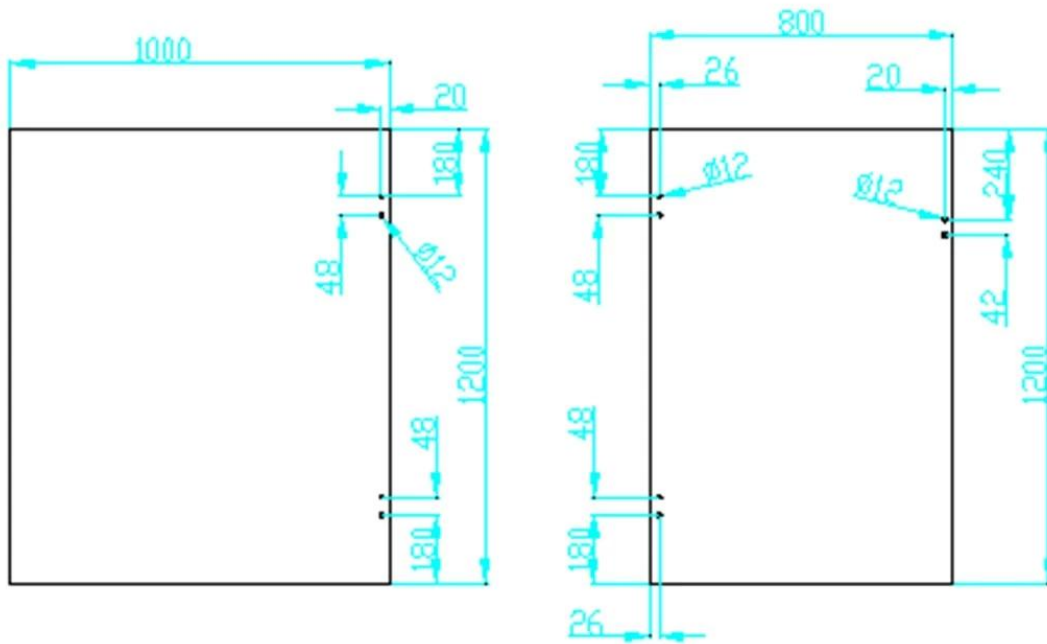

Project

Glass hinge is usually matched with [glass spigot](#) and glass latch







[Aluminum railing](#) pool fence system





For more beautiful pool fence project photos, go [here](#)

Packing & Delivery

One pc into one plastic bag, then into one box.













STEP 1
Remove grip screw and turn grip clockwise to reveal tension pin.

STEP 2
Remove grip screw from side of hinge with Allen Key supplied.

STEP 3
Turn the tension pin clockwise to the next hole in tension pin, then tighten the grip screw, repeat this process a maximum of three times or 360°. Do not over tension.



packing	plastic bag+box+carton
production lead time	30-45 days ; also depending on your qty.
Shippment	 
	 
	 
payment	 

Factory & Certification









Thank you for visiting. Please do not hesitate to contact us for a quote.

Contact:

E: Doris

Skype launch_04

KEBIL 科比奥®

深圳市朗驰商贸有限公司
SHENZHEN LAUNCH CO., LTD.

朗驰国际有限公司
LAUNCH INTERNATIONAL LIMITED.

董 萍 Doris Dong

Senior Sales Representative

☎ (86) 135 3050 6265

深圳市南山区南山大道1092号亿利达大厦B区3栋5003

Room 5003, Building 3, Yilida Building, No.1092
Nanshan Road, Nanshan District, Shenzhen, China
postal code 518054

☎ (86-755) 8603 7559

☎ (86-755) 8637 2611

✉ sales04@launch-china.cn

🌐 www.launch-china.com

www.chinabalustrade.com

Follow us on [Facebook](#), [Pinterest](#), [Linkedin](#)