

Product specification:

Product name	Stainless Steel Glass To Glass 90 Degree Corner Glass Clamp Clips
Material	Stainless steel 316 or 304
Surface finish	Satin brushed, mirror polished, matt black, gloss black, gold etc.
For glass thickness	10-12mm, other customized glass are available
Mounted	Glass to glass
Railing types	Mostly used for frameless glass railing
Application	Swimming pool fencing, balcony glass railing, etc.

Product show:





Technical Drawing:

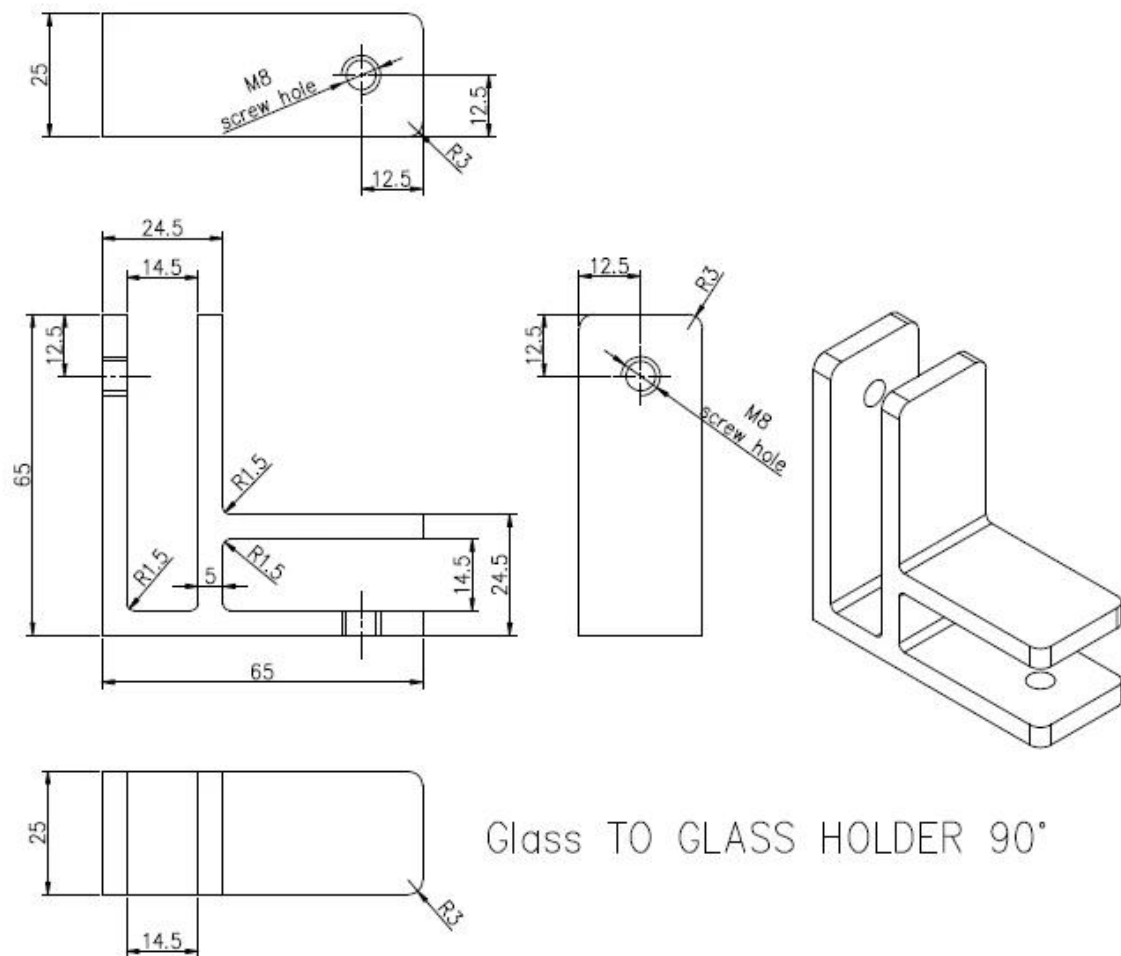

Glass TO GLASS HOLDER 90°

Production photos:





Project photos:





Contact information:

If you have any inquiries for them, please feel free to contact me.

Wendy

Email: sales04@launch-china.cn

Phone/WhatsApp/Wechat: +0086 159 8933 9827