

SGS certification Alibaba verified gold plus supplier & 16 years membership

COMPANY INTRODUCTION

Verification Type: Supplier Assessment Onsite Check

Country / Region:
Guangdong, China ✓

Year Established:
2004 ✓

Main Products:
CNC Machining Parts, Stamping Pa... ✓

Main Markets:
North America, Oceania, Mid East... ✓

Total Annual Revenue:
confidential ✓

Total Employees:
11 - 50 People ✓

Alibaba.com Gold Plus Supplier

Alibaba.com Gold Plus Supplier

Main Product Lines Verification Report

Verified

Assessment Report

Presented to

Presented to

Shenzhen Launch Co., Ltd.

Cooperation Company of Shenzhen Launch Co., Ltd.

深圳市朗驰商贸有限公司

深圳市朗驰商贸有限公司合作工厂

Company Address	B5003, Building 3, Yilida Building, No. 1092 Nanshan Avenue, Dengliang Community, Nanshan Street, Nanshan District, Shenzhen City, Guangdong Province, China
Consigner of Assessment:	Alibaba
Gold Supplier Member ID:	launch168
Gold Supplier Company Name:	Shenzhen Launch Co., Ltd.
Contact Person:	Mr. Binfeng Gao
Phone Number:	0086-13802569770
Fax Number:	0086-755-86372611
Email:	gbf999@china.com
Website Address (URL):	http://launch-china.en.alibaba.com

Gold Supplier & Assessed Company Relationship:	<input type="checkbox"/> Self-owned <input type="checkbox"/> Wholly Owned <input type="checkbox"/> Shareholder/Partner <input type="checkbox"/> Kindred between Owners <input checked="" type="checkbox"/> Cooperation Partner
Company Address	Confidential
City / Country:	Huizhou / China
Consigner of Assessment:	Alibaba & Shenzhen Launch Co., Ltd.
Gold Supplier Member ID:	launch168
Gold Supplier Company Name:	Shenzhen Launch Co., Ltd.
Contact Person:	Confidential
Phone Number:	Confidential
Fax Number:	Confidential
Email:	Confidential
Website Address (URL):	http://launch-china.en.alibaba.com

Service Provided by SGS
Report No.: 19536352_P+T

Service Provided by SGS
Report No.: 19552720_P



WHY CHOOSE US



15 YEARS EXPERIENCE

We have been manufacturing railing hardware since 2004.



ONE STOP SERVICE

We provide integrated railing solutions. We manufacture. We deliver.



PROFESSIONAL R&D TEAM

We have engineering experts for developing new products.



TOP QUALITY & GOOD PRICE

We are strict on quality control as well as cost evaluation.

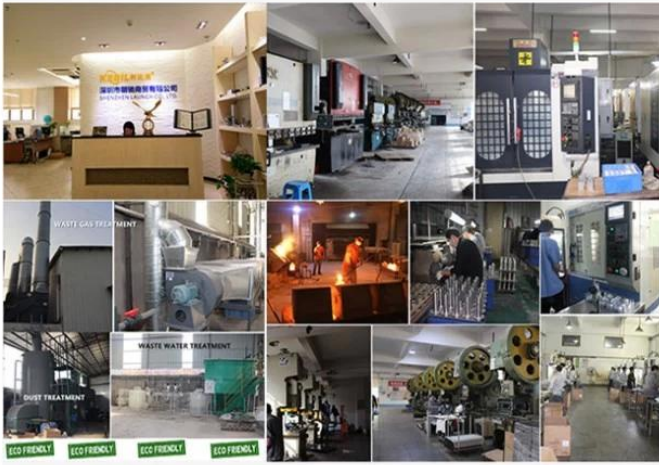

ABOUT US

Shenzhen Launch Co., Ltd was established in 2004, located at Nanshan District, Shenzhen, and one hour by car from Hongkong International Airport. Our main products are high-grade building materials including stainless steel balustrade post, staircase handrail, balcony guardrail, swimming pool fence and other high-grade building materials. All the products are designed strictly according to the high-end market requirements. We have our own factory in Tangxia Town, Dongguan, with more than 50 sets of various precision equipments, such as CNC lathe, milling machine, punching machine, pipe cutter, argon welder, drilling machine, polisher, etc. which can provide customers with complete product processing services.

U Channel Aluminum Base Shoes Balustrades & Handrails

Aluminum U channel railing profile specifications

- Material: aluminum 6063 T5
- Finish: anodizing
- Length: 4m per length or custom's length
- For glass thickness: 12-21.52mm tempered glass
- Sold as a kit: including bolts, rubber channel and fittings

Aluminum U channel for 12mm glass

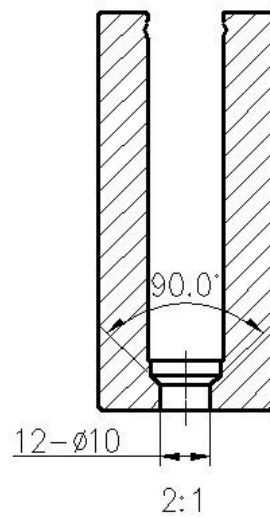
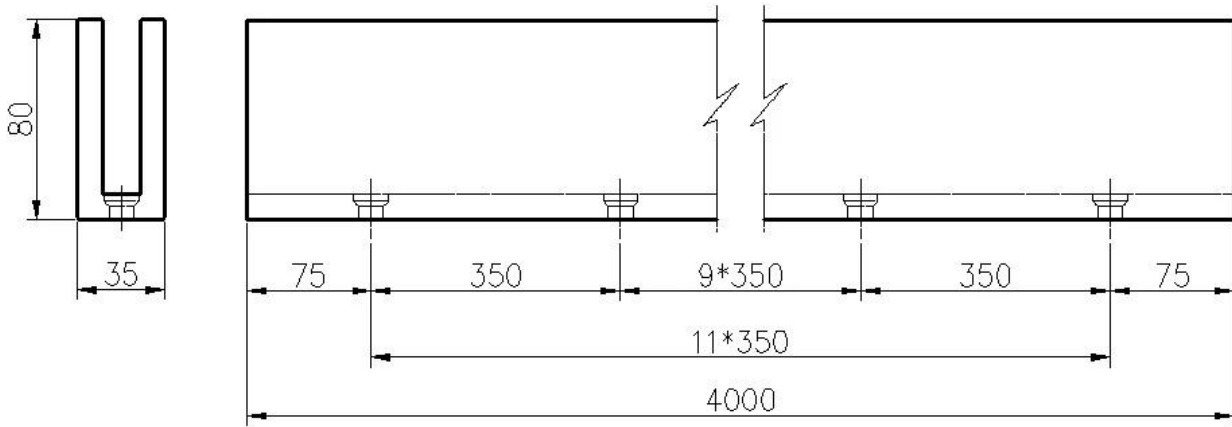
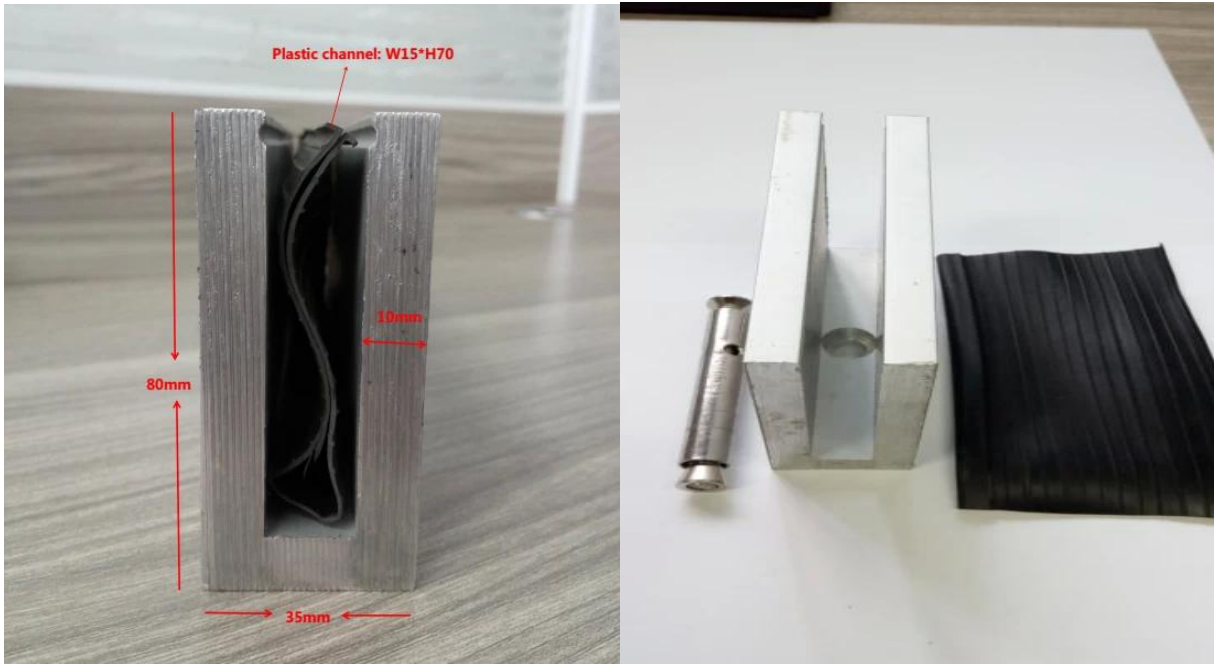

Aluminum U channel installation

installation

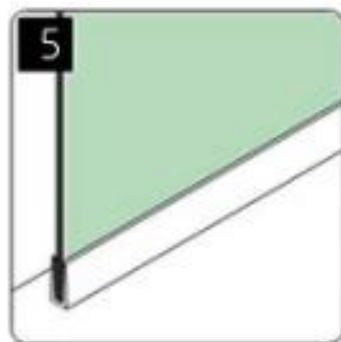
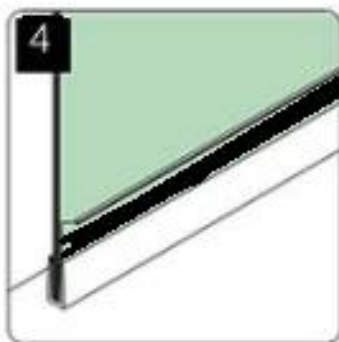
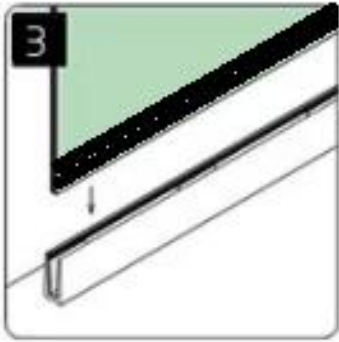
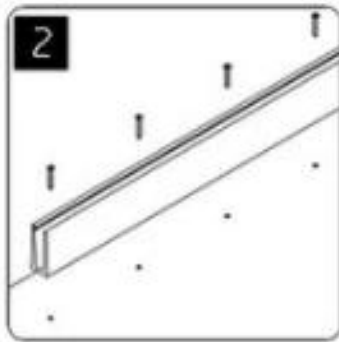
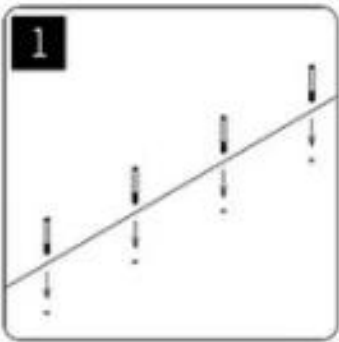

Other models aluminum U channel you may interest

LCH-C01



12 mm to 13.14 mm tempered glass

1 m aluminium groove contains the following accessories (excluding glass)



LCH-C02



12 mm to 13.14 mm tempered glass

1 m aluminium groove contains the following accessories (excluding glass)

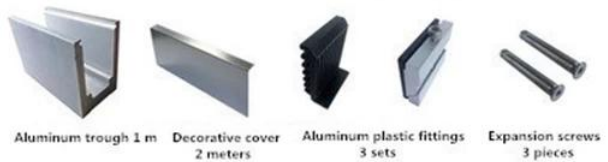

LCH-D01



12 mm to 13.14 mm tempered glass

1 m aluminium groove contains the following accessories (excluding glass)



Aluminum trough 1 m



Waterproof tape 2 meters



Aluminum plastic fittings 3 sets



Expansion screws 3 pieces

LCH-D02



12 mm to 13.14 mm tempered glass

1 m aluminium groove contains the following accessories (excluding glass)



Aluminum trough 1 m



Decorative cover 2 meters



Aluminum plastic fittings 3 sets



Expansion screws 3 pieces

LCH-B01



16 mm to 17.52 mm tempered glass

1 m aluminium groove contains the following accessories (excluding glass)



Aluminum trough 1 m



Waterproof tape 2 meters



Aluminum plastic fittings 3 sets



Expansion screws 3 pieces

LCH-B02



16 mm to 17.52 mm tempered glass

1 m aluminium groove contains the following accessories (excluding glass)



Aluminum trough 1 m



Decorative cover 2 meters



Aluminum plastic fittings 3 sets



Expansion screws 3 pieces

LCH-A01



20 mm to 21.52 mm tempered glass

1 m aluminium groove contains the following accessories (excluding glass)



LCH-A02



20 mm to 21.52 mm tempered glass

1 m aluminium groove contains the following accessories (excluding glass)

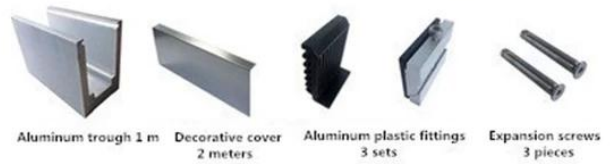

Alumnum U channel railing project photos





Aluminum U channel packge





Related products -- stainless steel C channel glass handrail capping





**Dia25.4mm slotted handrail tube
14x14mm groove**



180 degree joiner



90 degree joiner



wall-rail joiner



end cap



20*25mm slot handrail

5.8 m per length



180 degree joiner



90 degree joiner



Vertical adjustable joiner



Horizontal adjustable joiner



Wall to handrail joiner



End cap



Contact

Thank you for visiting ! Any question or inquiry, please leave a message. Will get back to you within 24 hours.

Any urgent inquiry, please contact us below:

-Contact: Wendy

-Email: sales04@launch-china.cn

-Office: (86-755)86037559

-Mob/whats app: 0086-159 8933 9827

-Skype: launch_04