

Aluminium Security Balustrades Aluminum Metal Frameless Profile U Channel Clamp Glass Railing



Aluminum Glass Railing specifications:

RAILING PART - BASEMENT	MATERIAL	DIMENSION(MM)	SURFACE FINISHED	SUITED GLASS THICKNESS (MM)
U Channel / U Profile	Aluminum Alloy	102*62	Anodizing / Spray Paint	12-13.52
		102*67		8+1.52+8
		102*70.5		10+1.52+10
Inside System & Bolt	3 or 4 meters per length			
Cladding	SUS 304 / SUS 316	102	Brushed / Mirror	/
Borracha	Plástico	Vários	Preto	Tudo



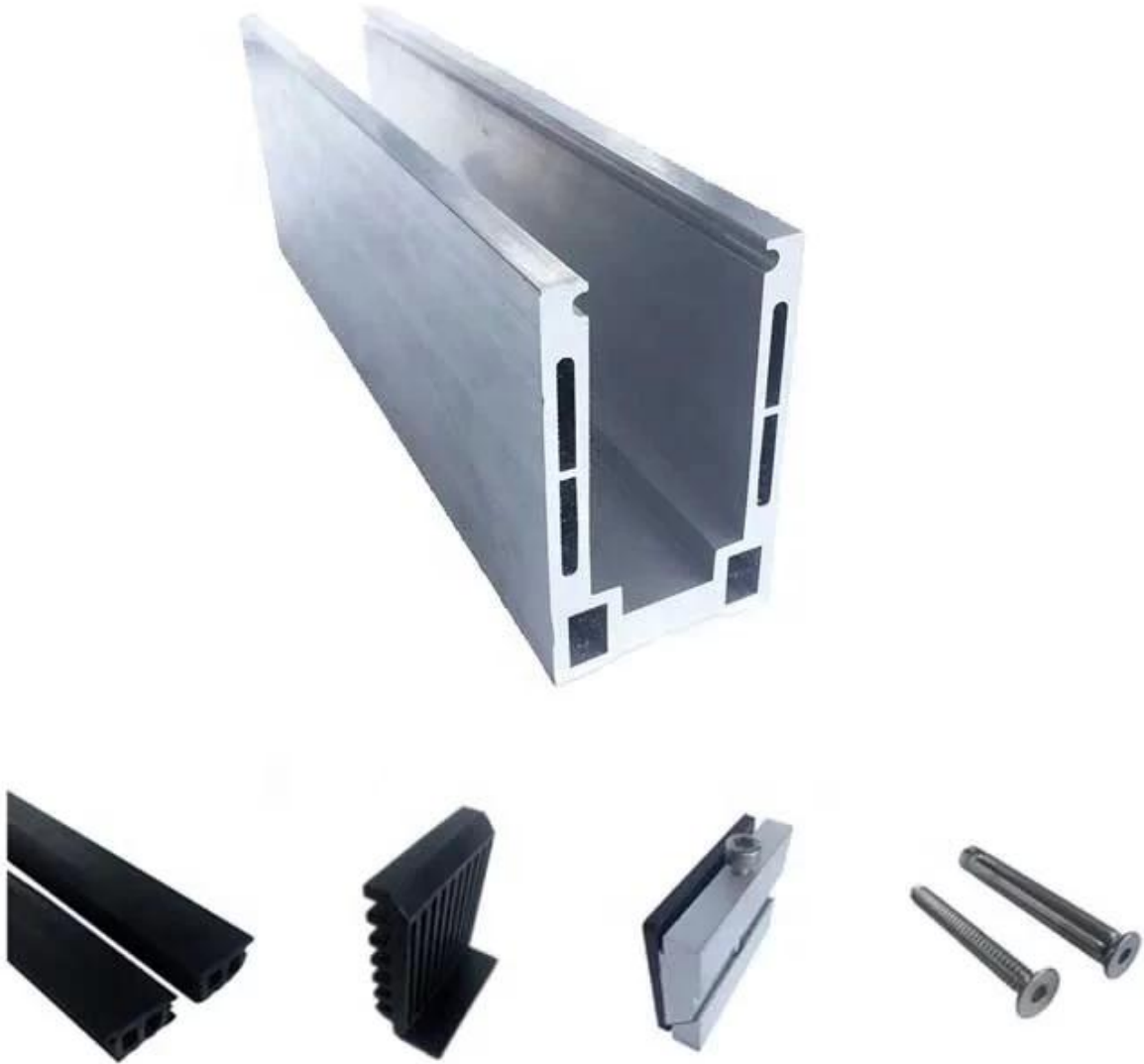

Aluminum Base U Profile for Glass Railing in Black Color:



Disponível Models:

LCH-A01/A02: without/with cladding for use with 20mm to 21.52mm glass

LCH-A01



20 mm to 21.52 mm tempered glass

1 m aluminium groove contains the following accessories (excluding glass)



Aluminum trough 1 m Waterproof tape 2 meters Aluminum plastic fittings 3 sets Expansion screws 3 pieces

LCH-A02



20 mm to 21.52 mm tempered glass

1 m aluminium groove contains the following accessories (excluding glass)

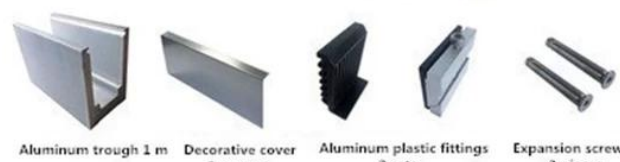

Aluminum trough 1 m Decorative cover 2 meters Aluminum plastic fittings 3 sets Expansion screws 3 pieces

LCH-B01/A02: without/with cladding for use with 16mm to 17.52mm glass

LCH-B01

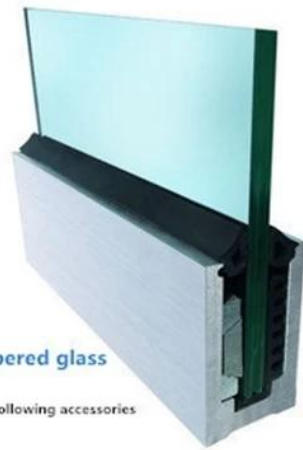

16 mm to 17.52 mm tempered glass

1 m aluminium groove contains the following accessories (excluding glass)



LCH-B02



16 mm to 17.52 mm tempered glass

1 m aluminium groove contains the following accessories (excluding glass)



LCH-C01/A02: without/with cladding for use with 12mm to 13.14mm glass

LCH-C01



12 mm to 13.14 mm tempered glass

1 m aluminium groove contains the following accessories (excluding glass)



LCH-C02



12 mm to 13.14 mm tempered glass

1 m aluminium groove contains the following accessories (excluding glass)

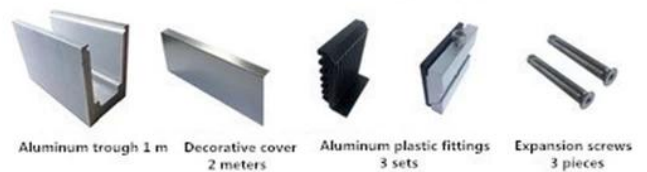

LCH-D01/A02: without/with cladding for use with 12mm to 13.14mm glass

LCH-D01



12 mm to 13.14 mm tempered glass

1 m aluminium groove contains the following accessories (excluding glass)



Aluminum trough 1 m



Waterproof tape 2 meters



Aluminum plastic fittings 3 sets



Expansion screws 3 pieces

LCH-D02



12 mm to 13.14 mm tempered glass

1 m aluminium groove contains the following accessories (excluding glass)



Aluminum trough 1 m



Decorative cover 2 meters



Aluminum plastic fittings 3 sets



Expansion screws 3 pieces

For both commercial and residential application
For both wholesale and retail (We are manufacturer)









MORE TYPES OF ALUMINIUM U CHANNEL FOR GLASS RAILING:

Small profile: for glass thickness 10-12.76mm

Big profile: for glass thickness 20-30mm

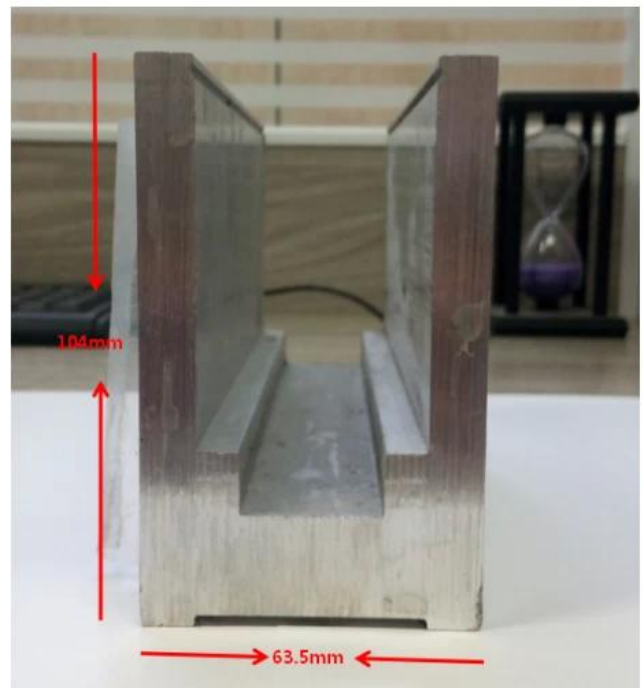
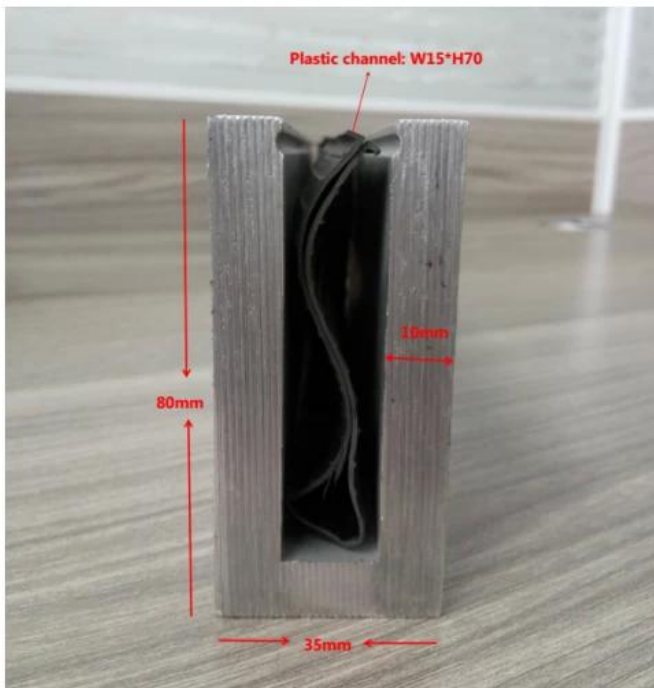

SLOT TUBE HANDRAIL:

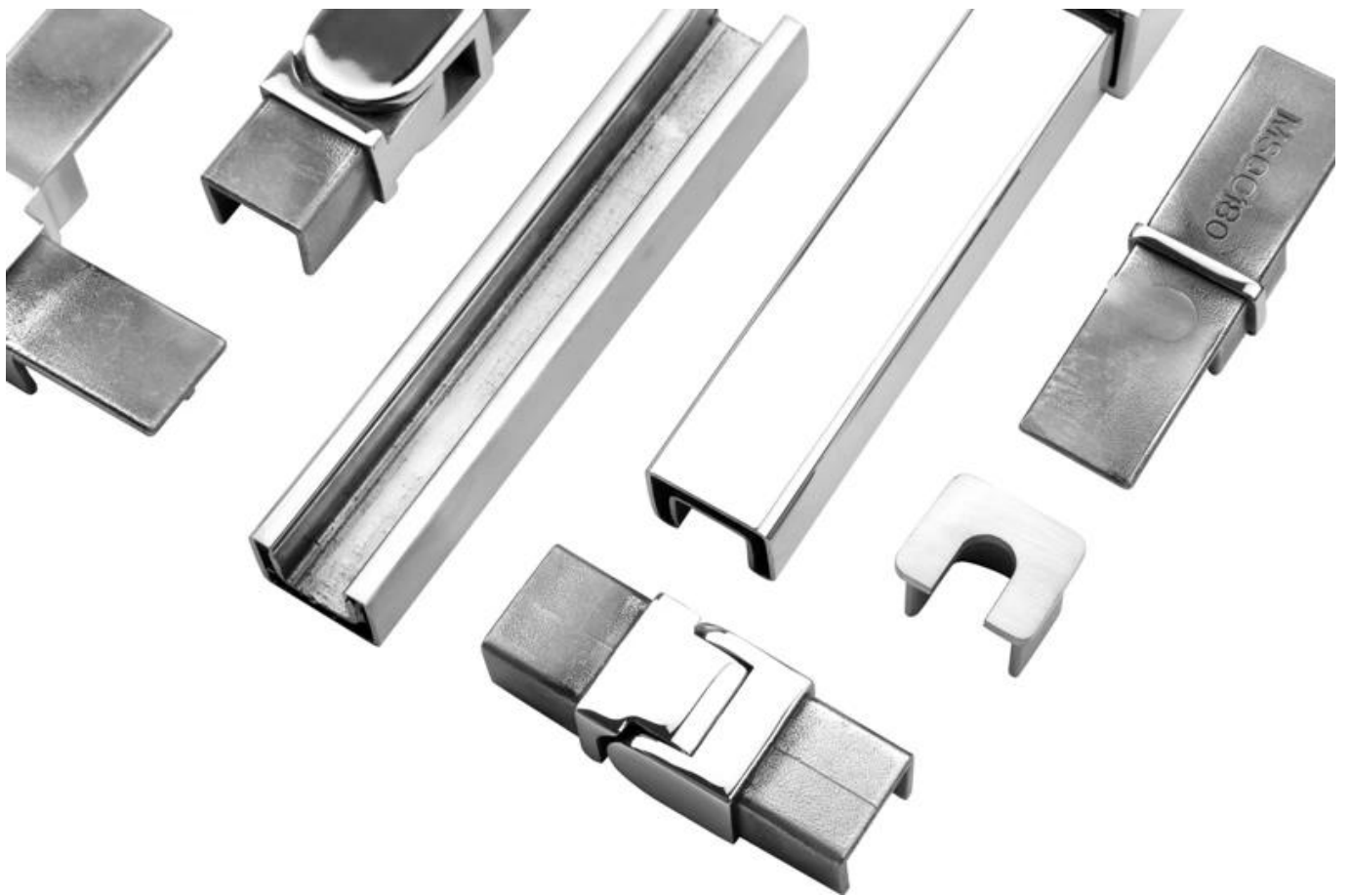



Perguntas frequentes

1. Are you factory?

Yes, we are factory.

2. Do you offer free samples?

Yes, we offer free samples, but customers need to pay express charges.

3. What materials do you have?

We have the material of stainless steel 304, 316, 316L and Duplex 2205.

4. What is your MOQ?

MOQ of order required is 1 pc.

5. What kind of payment do you accept?

We accept the payment of T/T, LC, PayPal, West Union, etc.

6. What is your payment term?

Our payment term is T/T(100% or 30/70)or LC at sight .

7. What is your delivery time?

Our delivery time is from 5days to 30days base on your quantity.

8. Do you offer OEM & ODM service?

Yes we offer OEM&ODM service.

9. Do you offer after-sales service?

Yes, we offer after-sales service. Any complaint for orders will be dealt with in time within 12 hours.

Contact us now for more information:

Véspera

Email: sales03@launch-china.cn

Mobile / Whatsapp: +8613686807796