

Descrição

- ..--Broca de núcleo quadrado torneira para aço inoxidável cerca de segurança da piscina
- Material: aço inoxidável 316, 316L, duplex2205
- Instalação: fixação em betão
- ..--Para a espessura do vidro: 10-13.52 mm (nós igualmente fornecemos vidro torneira de vidro de 15-16 mm)
- ..--Para segurar o copo largo de 1500mm
- Aplicação: cerca de seguro piscina cristalina, varanda sem moldura corrimão, deck guarda-corpo de vidro, cercas de jardim aço inoxidável, corrimão de aço inoxidável de quintal, balaustrada de vidro
- ..--Para commercial e projeto home casa moderna
- Para atacado e varejo (nós somos a fábrica)
- Amostra está sempre disponível
- ..--Passaram o teste de força

Detalhes de produtos

superfície do espelho



superfície de cetim



Fotos do projeto



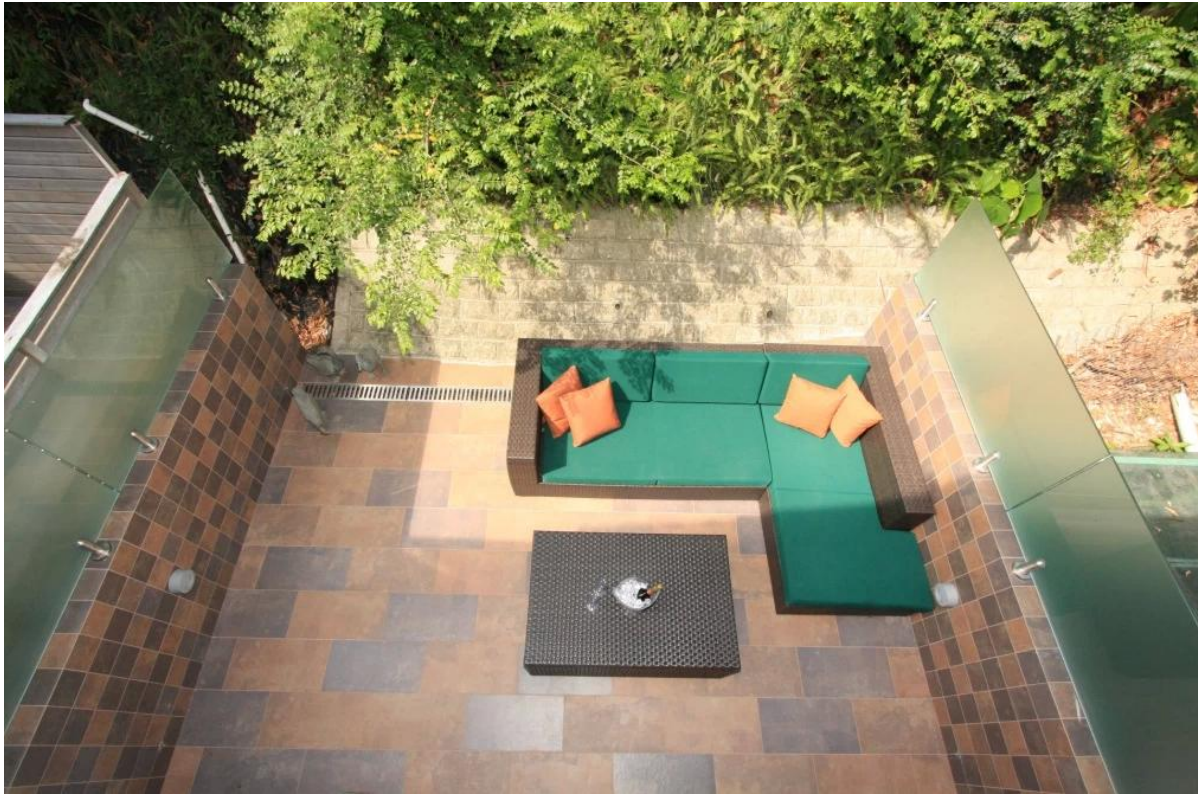

produtos relacionados: [trava da porta de vidro](#), [dobradiça de porta de vidro](#), [tubo do corrimão de slot](#)

Para mais inspiração de balaustrada de vidro, vá [AQUI](#)

Relatório de teste de força

Results Summary

(For details of individual tests, refer to the tables on the following pages.)

ID	Item/Heat No.	Dimensions/Type/Details	Finish	Overall Assessment
14117/01	SSBM316	180mm High, 50mm Square, Base Plate 316 Stainless steel	316L	COMPLIES

Remarks

After completion of the testing, the spigot was found to be in sound condition with no breakage, tearing or signs of fracture and no looseness of the fixings.

Colin Lorrimar
Metallurgical Testing Manager



Accreditation No. ~~14117~~ 14117
Accredited for compliance
with ISO/IEC 17025

Drawing

Project name

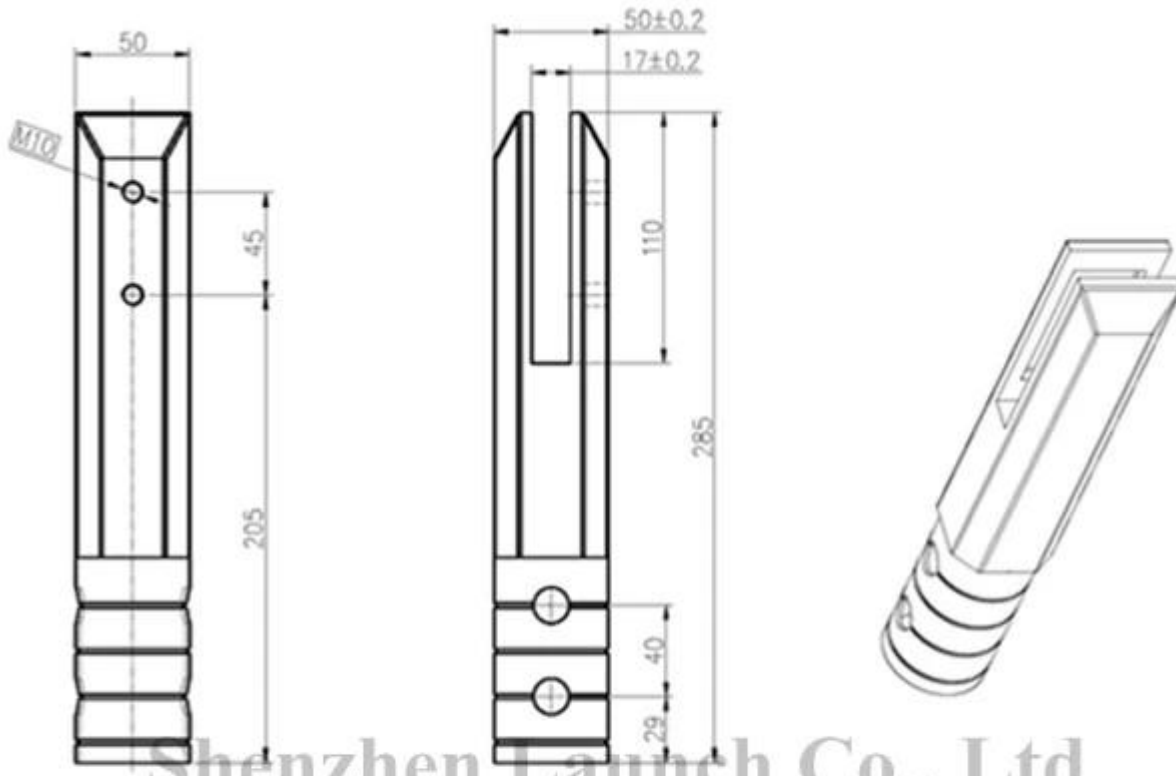

Shenzhen Launch Co., Ltd

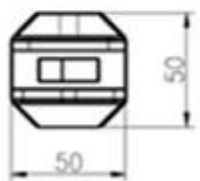









数量共页第页

深圳市朝陽貿易有限公司 SHENZHEN LAUNCH CO., LTD.		表面处理
设计	裴佳輝	材料
校对	图号:SCM	未
工艺	名称:Spigot	线性公差
审核	版次	角度公差
批准	Y001	

Empacotamento & entrega

- ..-Um pc em um saco plástico e, em seguida, em uma caixa. 20 pcs em uma caixa.
- Opção de envio: pelo mar (10-15 dias) /by ar (3-5 dias)



packing	plastic bag+box+carton
production lead time	30-45 days ; also depending on your qty.
Shippment	 
	 
	 
payment	 

Fábrica & certificação



KEBIL 科比奥™

ISO
9001:2008
REGISTERED

Factory Audit



www.launch-china.cn



Shenzhen Launch Co.,Ltd



www.launch-china.cn

Preciso de uma cotação ou quaisquer perguntas, por favor deixe uma mensagem.
Ou contacte-me como abaixo a informação. Vou ter de volta o mais rápido possível.

KEBIL 科比奥®

深圳市朗驰商贸有限公司
SHENZHEN LAUNCH CO., LTD.

朗驰国际有限公司
LAUNCH INTERNATIONAL LIMITED.

董 萍 Doris Dong

Senior Sales Representative

☎ (86) 135 3050 6265

深圳市南山区南山大道1092号亿利达大厦B区3栋5003

Room 5003, Building 3, Yilida Building, No.1092
Nanshan Road, Nanshan District, Shenzhen, China
postal code 518054

☎ (86-755) 8603 7559

☎ (86-755) 8637 2611

✉ sales04@launch-china.cn

🌐 www.launch-china.com

www.chinabalustrade.com