

Borne quadrado de aço inoxidável do balaústre da aranha para projetos de trilhos da plataforma da escada do balcão de vidro



1. Especificações quadradas do baluster da coluna da aranha do aço inoxidável :

produtos Nome	Balaustrada Quadrada em Aço Inoxidável
Modelo não.	LCH-121
Material	Aço inoxidável 304/316
Terminar	Escovado ou espelho polido
Tamanho quadrado post	Espessura de parede de 50 x 50 x 1,5 mm Espessura de parede 40 x 40 x 1,5 mm
Altura	Customizável
Para espessura de vidro	10-15 mm
Aplicação	Projeto trilhos varanda Projeto de guarda-corpo de alpendre Projeto de trilhos de convés Projeto trilhos da escada

Poste final com encaixe de aranha de 1 via

Poste de corrimão central com encaixe de aranha de 2 vias

Altura padrão: 1100 mm (disponíveis para postes do cliente)

Projetado para 10-15mm de vidro ou como por sua exigência

Ângulos ajustáveis destacam-se design para escada ou varanda etc.

KEBIL 科比奥®



2. Aço Inoxidável Aranha Quadrada Pós Dimension Desenho Para sua referência:

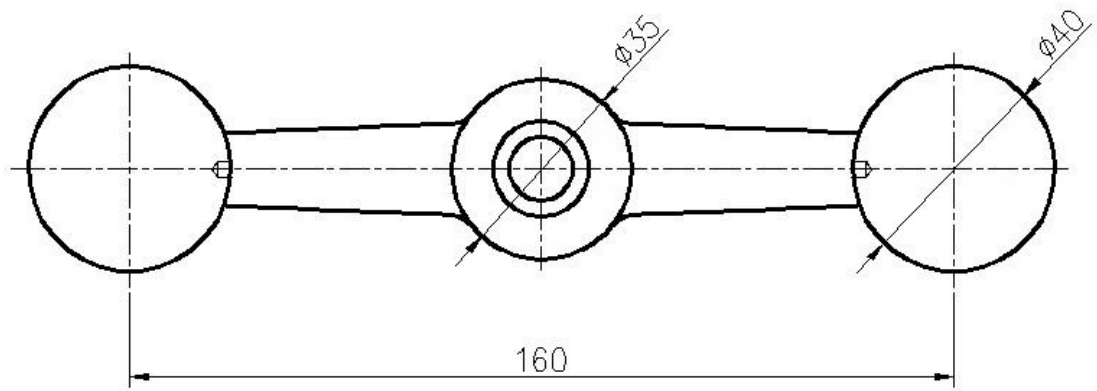
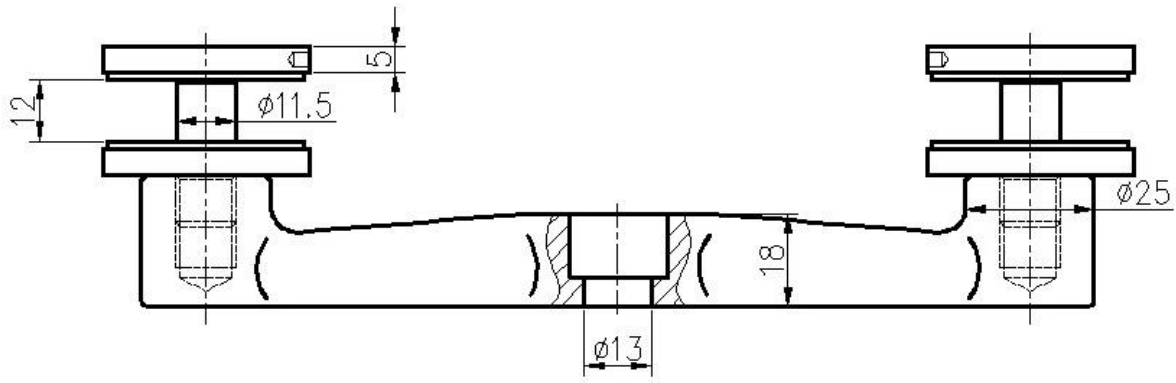

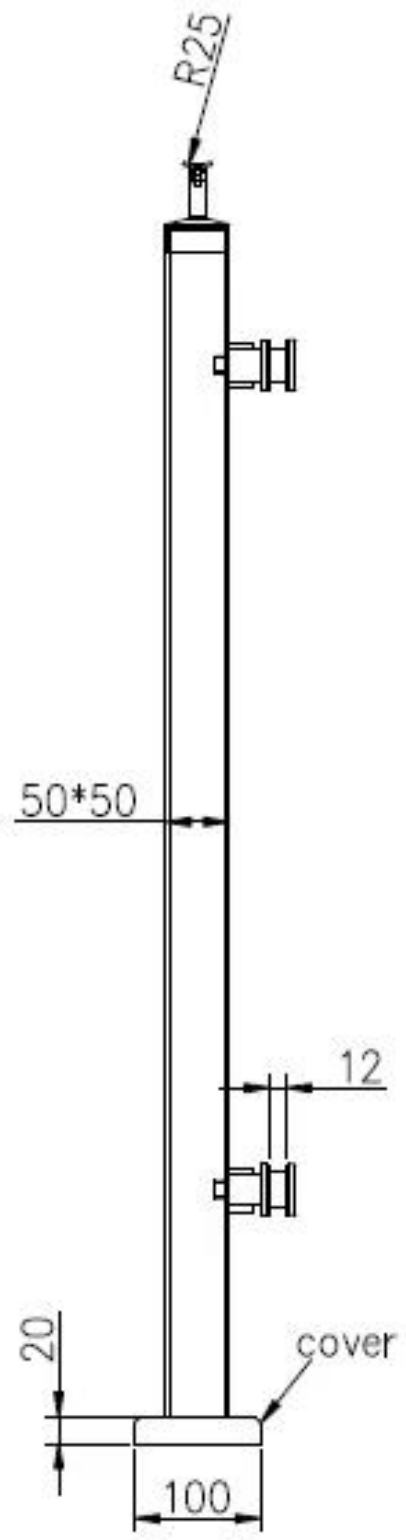
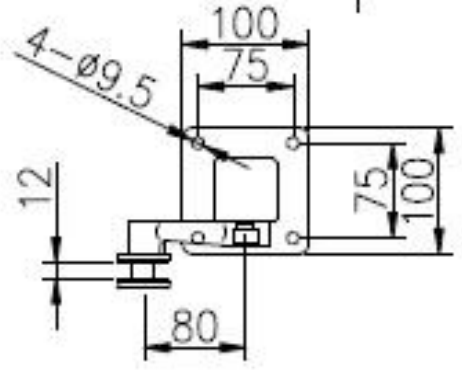
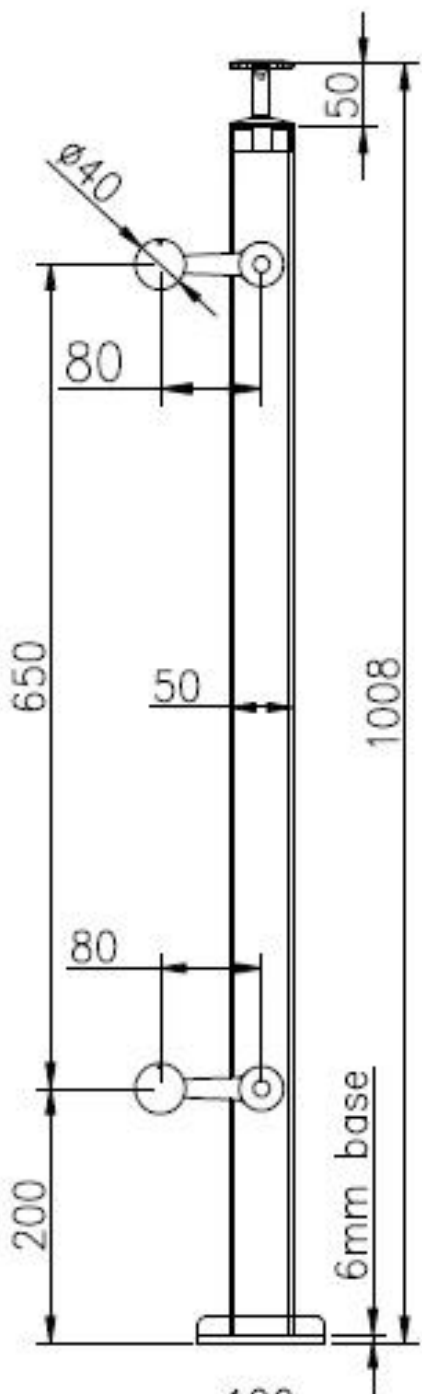

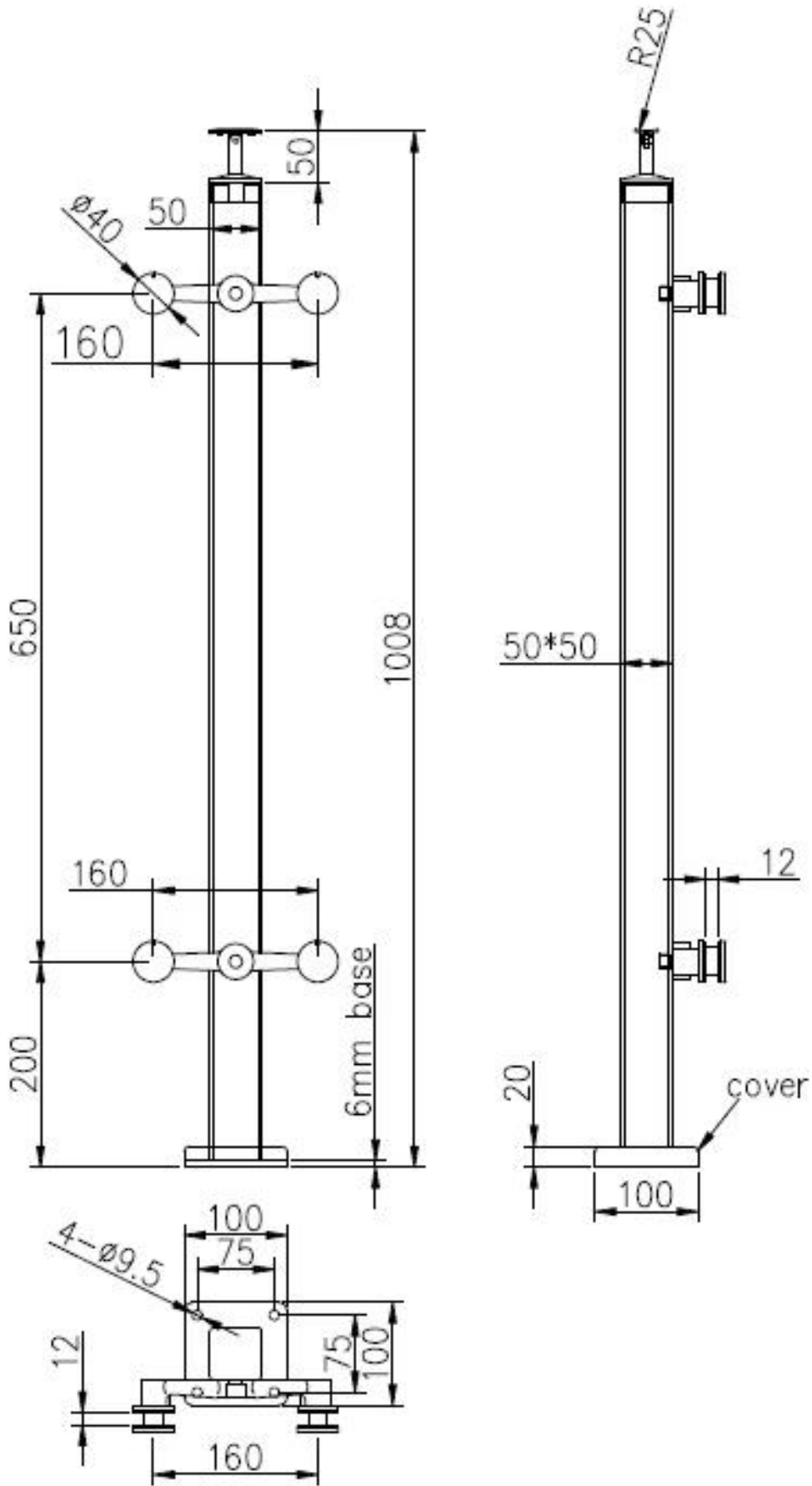

3. Aço Inoxidável Aranha Baluster Post Fotos:

Suporte de corrimão ajustável superior para corrimão de tubo quadrado ou redondo:



Post Intermediário de 2 vias:





Postagem final de 1 via:



4. Fotos de embalagem: 1 pc / saco de plástico, 2 - 4 pcs / ctn.





Empresa Em formação:

Shenzhen Launch Co., Ltd was established in 2004, located at Nanshan District, Shenzhen, and one hour by car from Hongkong International Airport. Our main product is high-grade building materials includes stainless steel balustrade post, staircase handrail, balcony guardrail, swimming pool fence and other high-grade building materials. All the products are designed strictly according to the high-end market requirements. We have our own factory in Tangxia Town, Dongguan, has a variety of precision equipment more than 50 sets: CNC lathe, milling machine, punching machine, pipe cutter, argon welder, drilling machine, polisher, etc. which can provide customers with complete product processing services. With the German SPECTRO Spectrometer, we insist on testing every batch of materials to ensure that the material is highly qualified. We also have hardness gauge, secondary element and other test equipment to ensure the products meets customers' requirements.

ABOUT US

Our Team



OUR ADVANTAGE

Please do not hesitate to contact us if you have any requirement regarding our production lines, you can expect a timely reply with professional solutions!



Own factory, shortest lead time.



Can help customers design product drawings based on customer ideas and design engineering installation drawing according to the customer site sketch.



Sample order, trial order acceptable.



Provide material test report to ensure that the material is qualified.



13 years of industry experience, we can help customers recommend the best solution to help customers save cost.

OUR FACTORY

More than 13 years experience in hardware industry design and processing, we can provide customized services from design to the sample and small batch trial production.



OUR CERTIFICATE

With premium quality, competitive price and superior service, we won a lot of customers' favor.
Our products are popular in North America, European and Australia.



PRODUCTION PROCESS



Casting



CNC lathe



CNC Milling



Stamping



Drilling & Tapping



Polishing



PACKAGING & DELIVERY



PAYMENT & TRANSPORTATION

Welcome Alibaba Trade Assurance Order!

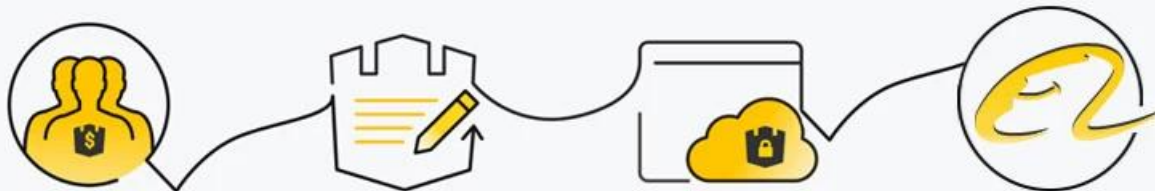

1 Start an order

2 Negotiate terms with our sales service & confirm order

3 Make payment

4 Alibaba provide full assurance



Por favor entre em contato conosco livremente para mais informações:

Email: sales03@launch-china.cn

Contato: Eve Chow

WhatsApp / HP: +8615907334556